

NORLAND®

ELITE

DXA Bone Densitometer Operator's Guide



Elite Model 437A150

NOTICE TO USERS OF THE BONE ASSESSMENT PRODUCT

DESCRIPTIONS NOT INTENDED FOR DIAGNOSTIC PURPOSES. The descriptions and narratives in this Operator's Guide and other written materials provided to Licensee with this Bone Assessment Product are intended to provide a foundation for use of the Bone Assessment Product along with host computer and printer. Actual printout images and any depictions of these images in the Operator's Guide and accompanying written materials are not intended for diagnostic purposes.

X-RAY DEVICE REGISTRATION. The Bone Assessment Product is an x-ray device that emits small amounts of radiation to acquire bone density and / or other information. Although the dose is very small, some countries and all states in the United States require registration of such devices, regardless of dose. It is the purchaser's responsibility to contact the government agency responsible for x-ray devices and to comply with any specific information concerning device registration and operation for the area in which the system is to be operated.

CHANGES IN SPECIFICATIONS FOR BONE ASSESSMENT PRODUCT. All specifications for the Bone Assessment Product are subject to change without notice.

Copyright © 2016-2018 Norland, Fort Atkinson, WI USA.

Contents of this Operator's Guide and other written materials provided to Licensee with the Bone Assessment Product may not be reproduced by any means whatsoever without prior written permission from Norland. All products mentioned in this Operator's Guide and related written materials are trademarked or copyrighted by their manufacturers.

All Norland Products are covered by U.S. and other patents and/or patents pending. All product names are trademarks of Norland. All trademarks and the rights of the trademarks owned by the companies referred to in this Operator's Guide and other written materials provided to Licensee with the Bone Assessment Product are acknowledged.

WARRANTY FOR BONE ASSESSMENT PRODUCT

The Bone Assessment Product manufactured by Norland is warranted against defects in material and workmanship for twelve (12) months from date of installation. During the warranty period, Norland will repair or replace (at its option) a Bone Assessment Product proven to be defective. Warranty repairs may be performed on site, at the factory, or at a Norland-approved service center without charge, provided the Bone Assessment Product was not subjected to misuse, theft, neglect, fire, Acts of God, lightning strikes, or deterioration caused by chemicals that are not used for normal unit operation. Any modifications of the Bone Assessment Product in any manner, including but not limited to relocation or installation of the Bone Assessment Product without prior Norland Customer Service authorization, shall void all associated warranties or service contracts. Prior to pre-paid return of products for repair, the Bone Assessment Product must have a Return Authorization Number (obtainable from Norland Customer Service) attached to it.

BEYOND THE WARRANTIES STATED ABOVE, THERE ARE NO OTHER WARRANTIES OF ANY KIND, EXPRESS, IMPLIED OR STATUTORY (INCLUDING, WITHOUT LIMITATION, TIMELINESS, TRUTHFULNESS, SEQUENCE, COMPLETENESS, ACCURACY, FREEDOM FROM INTERRUPTION), ANY IMPLIED WARRANTIES ARISING FROM TRADE USAGE, COURSE OF DEALING, OR COURSE OF PERFORMANCE, OR THE IMPLIED WARRANTIES OF MERCHANTABILITY OR FITNESS FOR A PARTICULAR USE OR PURPOSE. LICENSEE'S EXCLUSIVE REMEDY FOR BREACH OF WARRANTY OR BREACH OF CONTRACT, NEGLIGENCE OR PRODUCTS LIABILITY SHALL BE THE REPAIR OR REPLACEMENT OF DEFECTIVE OR DAMAGED GOODS.

SOFTWARE LICENSE AGREEMENT

PLEASE READ THIS SOFTWARE LICENSE AGREEMENT CAREFULLY BEFORE USING THE SOFTWARE. BY USING THE SOFTWARE, YOU ARE AGREEING THAT THIS SOFTWARE LICENSE AGREEMENT FORMS A LEGALLY BINDING CONTRACT BETWEEN YOU AND NORLAND AND THAT THIS AGREEMENT CONSTITUTES A "WRITING SIGNED BY YOU" UNDER ANY APPLICABLE LAW OR REGULATION. ANY RIGHTS NOT EXPRESSLY GRANTED HEREIN ARE RESERVED BY NORLAND. IF YOU DO NOT AGREE TO THE TERMS OF THIS LICENSE, DO NOT USE THE SOFTWARE AND RETURN THE BONE ASSESSMENT PRODUCT TO NORLAND.

1. **DEFINITIONS.** The word "**Software**" means the software in object code form and any documentation which you have received from Norland in connection with the Norland Bone Assessment Product, whether incorporated into the Product or not. The phrase "**Claims or Losses**" means any and all liabilities, obligations, losses, damages, penalties, claims, actions, suits, costs, judgments, settlements, and expenses of whatever nature, whether incurred by or issued against an indemnified party or a third party, including, without limitation: (a) indirect, special, punitive, consequential or incidental loss or damage (including, but not limited to, trading losses, loss of anticipated profits, loss by reason of shutdown in operation or increased expenses of operation, or other indirect loss or damage) and (b) administrative costs, investigatory costs, litigation costs, and auditors' and attorneys' fees and disbursements (including in-house personnel). The word "**Licensee**" or "**you**" shall mean you, the individual or entity which has purchased the Bone Assessment Product and accompanying Software, and has agreed to this License by using the Software and has not returned the Bone Assessment Product to Norland.
2. **LICENSE; INTELLECTUAL PROPERTY RIGHTS.** Norland grants to Licensee a nonexclusive, royalty-free, non-transferable license during the term of the Agreement to receive and use the Software solely in connection with Licensee's use of the Bone Assessment Product. The Software is licensed only for the internal use of Licensee and its employees. Licensee may not sell, lease, furnish, redistribute, retransmit, or otherwise permit or provide access to the Software to any other person. Licensee will not engage in the operation of any illegal business or use or permit anyone else to use the Software, or any part thereof, for any illegal purpose. Licensee shall take reasonable security precautions to prevent unauthorized persons from gaining access to the Software. Licensee acknowledges that Norland retains proprietary rights in the Software. In the event of any misappropriation or misuse, in addition to its right to damages Norland shall have the right to obtain injunctive relief. Licensee agrees not to decompile, disassemble or reverse engineer the Software.
3. **NORLAND'S WARRANTIES/DISCLAIMER OF WARRANTIES.** The Software is designated for use with the Norland Bone Assessment Product and is warranted to execute its programming instructions when properly installed in that product. Accessory products, including software, not manufactured by Norland carry the warranties of their respective manufacturers. Norland does not warrant that the operation of the Software shall be uninterrupted or error free. **BEYOND THE WARRANTIES STATED IN THIS SECTION, THERE ARE NO OTHER WARRANTIES OF ANY KIND, EXPRESS, IMPLIED OR STATUTORY (INCLUDING, WITHOUT LIMITATION, TIMELINESS, TRUTHFULNESS, SEQUENCE, COMPLETENESS, ACCURACY, FREEDOM FROM INTERRUPTION), ANY IMPLIED WARRANTIES ARISING FROM TRADE USAGE, COURSE OF DEALING, OR COURSE OF PERFORMANCE, OR THE IMPLIED WARRANTIES OF MERCHANTABILITY OR FITNESS FOR A PARTICULAR USE OR PURPOSE.**
4. **NORLAND'S LIMITATION OF LIABILITY.**
 - a. Under no circumstances, including negligence, shall Norland shall be liable to Licensee or any other person for indirect, special, punitive, consequential or incidental loss or damage (including, but not limited to trading losses, loss of anticipated profits, loss by reason of shutdown in operation or increased expenses of operation, cost of cover, or other indirect loss or damage) of any nature arising from any cause whatsoever, even if Norland has been advised of the possibility of such damages. In no event shall Norland's total liability to you or any other person for all damages exceed fifty dollars (\$50).
 - b. Norland shall not be liable to Licensee or any other person for any unavailability, interruption, delay, incompleteness, or inaccuracy of the Software.

- c. The Parties acknowledge that the terms of this section reflect a reasonable allocation of risk and limitation of liability.
5. **FORCE MAJEURE.** Notwithstanding any other term or condition of this Agreement, Norland or Licensee shall not be obligated to perform or observe their respective obligations undertaken in this Agreement (except for obligations to make payments hereunder and regulatory obligations) if prevented or hindered from doing so by any circumstances found to be beyond their control.
 6. **LICENSEE INDEMNITY.** Licensee will indemnify and hold harmless Norland and its employees, officers, directors, and other agents from any and all Claims or Losses imposed on, incurred by or asserted as a result of or relating to: (a) any noncompliance by Licensee with the terms and conditions hereof; or (b) any third-party actions related to Licensee's receipt and use of the Software, whether authorized or unauthorized under the Agreement.
 7. **ENFORCEMENT.** Norland may enforce the terms of this Agreement against Licensee itself or against any person, whether or not Licensee is a party to such action. In any action there shall be available injunctive relief or damages, with the prevailing party being awarded costs and attorneys' fees (including in-house counsel).
 8. **TERMINATION** In the event of (a) Licensee breach or (b) where directed to do so by any person in its regulatory authority, Norland may terminate this Agreement at any time immediately upon written notice to Licensee provided by Norland.
 9. **MISCELLANEOUS.** Except as otherwise provided herein, no provision of this Agreement may be amended, modified, or waived, unless by an instrument in writing executed by a duly authorized officer of the party against whom enforcement of such amendment, modification or waiver is sought. No failure on the part of Norland or Licensee to exercise any right, power or privilege under this Agreement shall operate as a waiver thereof, nor shall any single or partial exercise of such right, power or privilege preclude any other or further exercise thereof or the exercise of any other right, power or privilege under this Agreement. If any of the provisions of this Agreement, or application thereof to any person or circumstance, shall to any extent be held invalid or unenforceable, the remainder of this Agreement, or the application of such terms or provisions to persons or circumstances other than those as to which they are held invalid or unenforceable, shall not be affected thereby and each such term and provision of this Agreement shall be valid and enforceable to the fullest extent permitted by law.
 10. **SURVIVAL.** The terms of this relating to intellectual property and indemnification shall survive termination of this Agreement.
 11. **GOVERNING LAW AND FORUM.** Each party hereby irrevocably and unconditionally submits for itself and its property, to the jurisdiction of any New York State court or federal court of the United States of America sitting in New York County and to any other court in any jurisdiction in which an action is brought against a party to this agreement by a third party asserting a claim against which Norland is entitled under this agreement to be indemnified. In any action or proceeding arising out of or relating to this agreement or for recognition or enforcement of any judgment, all claims in respect of any such action or proceeding may be heard and determined in any such New York State court or by such federal or other court. A final judgment in any such action or proceeding shall be conclusive and may be enforced in other jurisdictions by suit on the judgment or in any other manner provided by law.

Each party irrevocably and unconditionally waives, to the fullest extent it may legally and effectively do so, any objection that it may have or hereafter have to the laying of venue of any suit, action or proceeding arising out of or relating to this agreement in any New York State or federal court sitting in New York County or such other court. Each party irrevocably waives to the fullest extent permitted by law, the defense of an inconvenient forum to the maintenance of such action or proceeding in any such court.

Contents

Contents

Introduction

Indications for Use	1-2
Contraindications	1-2
X-Ray Device Registration	1-2
Customer Service Contact Information	1-3
About This Manual	1-4
Symbols List	1-6
ON/OFF Power Switch	1-6
Scanner Arm Touch Pad Symbols	1-7

General Information

Radiation Safety Precautions	2-2
Stay Out of the Beam	2-2
Avoid Scatter Radiation	2-2
State Requirements	2-2
Control General Access	2-2
Radiation Safety Features	2-3
Exposure Control	2-3
Technique Factors	2-3
Communication Watchdog	2-3
Exposure Indicators	2-3
Radiation Shielding	2-3
Audible Indicator	2-3
Scanner Features	2-3
Dual Energy X-Ray Absorptiometry (DXA)	2-4
Dynamic Filtering	2-4
System Components	2-5
Scanner Unit	2-5
Scanner Arm Touch Pad	2-5
Laser Positioning Aid	2-6
Computer/Controller	2-6
Software	2-6
Accessories	2-6
QA Calibration Standard	2-6
QC Phantom	2-6
Patient Positioning Aids	2-7
Quality Assurance Program	2-8
Patient Comparison	2-8
Trend Comparison	2-9
Precision	2-9
Accuracy	2-10
Standard Deviation (S.D.)	2-10
Coefficient of Variation (C.V.)	2-10
Reference Set Comparison	2-10
Scan Reports	2-12
Generating a Report	2-12
The “Reports” Tab	2-14

Editing the Patient Letter or Referral Letter	2-16
Sample Scan Reports	2-17
The Bone Exam Report	2-17
1: A Sample “Bone Exam Report”	2-18
2: A Sample “Bone Exam Report - 1 Page”	2-20
3: A Sample “Combined Report”	2-21
4: A Sample “Patient Letter”	2-22
5: A Sample “Referral Letter”	2-24
6: A Sample “Ten Year Fracture Risk Report”	2-26
7: A Sample “Body Composition Report”	2-28
Quality Assurance Reports	2-30
Sample Reports: Quality Assurance Report - BMD	2-31
Sample Reports: Quality Assurance Report - Fat	2-32
Sample Reports: Quality Assurance Report - Lean	2-33

Installation and Setup

Software Installation Instructions	3-2
Installing the IlluminatusDXA Software	3-2
Configuring Backup for Windows 10	3-6
Configuring Backup for Windows 7	3-7
Installing the Microphone	3-7
Uninstalling the Software	3-9
Logging into the Illuminatus DXA Software	3-12
Examining the Software	3-13
Database Navigator Window	3-14
Database Navigator Window Description	3-15
Menu Commands Overview	3-16
File Command	3-17
Quick Descriptions: File drop-down list	3-17
Edit Command	3-18
Quick Descriptions: Edit drop-down list	3-18
User Preferences	3-18
Scanner Preferences	3-18
Advanced Preferences	3-18
Users and Groups	3-18
User Preferences Command	3-20
Scanner Preferences Command	3-21
Site Tab Setup	3-22
Scanning Tab Setup	3-23
Analysis Tab Setup	3-31
Service Tab Setup	3-39
Advanced Preferences Command	3-40
System Tab (under the Basic Settings tab)	3-40
Customer Info Tab (under the Basic Settings tab)	3-40
Printing Tab (under the Reporting tab)	3-41
Directories Tab	3-42
Directory Settings for the MAPI Server Type	3-42
Network Tab	3-43
Users and Groups Command	3-45
Calibration Command	3-47
Quick Descriptions: “Calibration” drop-down list	3-47
Tools Command	3-48

Quick Descriptions: “Tools” drop-down list	3-48
Find Origin	3-49
Table Limits	3-50
Begin Initial Calibration	3-51
Help Command	3-52
Quick Descriptions: “Help” drop-down list	3-52
Basic Operation	
Patient Scanning Procedure Overview	4-2
Guidelines for Attaining Precision and Accuracy	4-2
Powering Up the System	4-3
Logging into the Norland Software	4-4
Daily Calibration Procedure	4-6
1. Check the Standard and QC Phantom for Damage	4-6
2. Position the Standard and the Phantom on the Scanner	4-7
3. Calibrate the System Using the QA Calibration Standard	4-8
4. Calibrate Using the QC Phantom	4-10
5. Automatic System Diagnostic Tests	4-11
6. Verify the Calibration	4-13
7. View and Print Calibration Results Reports	4-14
Sample Printed QA Results Report	4-16
When to Repeat the Calibration	4-17
To Stop the Calibration	4-17
QA Results tab Window Interpretation	4-18
QC Results Statistics Messages	4-19
Preparing Patient Records	4-21
Creating a New Record for a New Patient	4-21
Locating a Record for an Existing Patient	4-22
A: Search in the “Patient Name” Column	4-22
B: “Quick Search” by Last Name	4-22
C: “Quick Search” by Patient ID	4-23
Enter Data into the Existing Patient’s Record	4-24
Patient Demographics Window Details	4-25
Button Functions	4-25
Field Entry Details	4-25
How to Customize a “Drop-Down List” Field	4-30
Beginning the Patient Scan	4-33
System Shutdown	4-34
Scanning Whole Body	
Scan Specifications	5-2
Patient Dose	5-2
Operator Dose	5-2
Maintaining High Quality Whole Body Scans	5-3
General Patient Scanning Cautions	5-4
Quick Reference - Whole Body Scan	5-5
Scan Procedures	5-6
Checklist	5-6
Preparing the Patient for Scanning	5-6
Update (or Create) the Patient’s Record	5-6
Setting the Scan Parameters	5-7
Positioning the Patient	5-9

Marking the Scan Region	5-10
Starting the Measure Scan	5-13
Analyzing the Scan	5-15
Viewing the Scan Results Tab	5-18
Generate and Print a Report	5-20
A Sample Bone Exam Report	5-22
Soft Tissue Composition	
Introduction	6-2
Tissue Composition Standards	6-2
Scan Specifications	6-3
Whole Body Scans	6-4
Soft Tissue Composition - Whole Body Scans	6-4
Results - Whole Body Scan	6-4
Body Fat Charts - Whole Body Scan	6-5
Research & Small Subject Scans	6-6
Soft Tissue Composition - Research & Small Subject Scans	6-6
Results - Research & Small Subject Scans	6-6
Generate and Print a Report	6-7
A Sample Bone Exam Report	6-9
A Sample Body Composition Report	6-11
Scanning AP Spine	
Scan Specifications	7-2
Patient Dose	7-3
Operator Dose	7-3
Maintaining High Quality AP Spine Scans	7-4
General Patient Scanning Cautions	7-5
Quick Reference - AP Spine Scan	7-6
Scan Procedures	7-7
Checklist	7-7
Preparing the Patient for Scanning	7-7
Update (or Create) the Patient's Record	7-7
Setting the Scan Parameters	7-8
Positioning the Patient	7-10
Marking the Scan Region	7-12
Starting the Measure Scan	7-14
Analyzing the Scan	7-17
Viewing the Scan Results Tab	7-21
Definitions of Scan Results	7-23
Fracture Risk Assessment	7-23
Generate and Print a Report	7-24
A Sample Bone Exam Report	7-26
Scanning Hip	
Scan Specifications	8-2
Patient Dose	8-3
Operator Dose	8-3
Maintaining High Quality Hip Scans	8-4
General Patient Scanning Cautions	8-5
Quick Reference - Hip Scan	8-6
Scan Procedures	8-7

Checklist	8-7
Preparing the Patient for Scanning	8-7
Update (or Create) the Patient's Record	8-7
Setting the Scan Parameters	8-8
Positioning the Patient	8-10
Marking the Scan Region	8-16
Starting the Scout Scan	8-18
Starting the Measure Scan	8-21
Analyzing the Scan	8-23
Viewing the Scan Results Tab	8-26
Definitions of Scan Results	8-28
Fracture Risk Assessment	8-28
Generate and Print a Report	8-29
A Sample Bone Exam Report	8-31
Research & Small Subject Scan	
Introduction	9-2
Scan Specifications	9-2
Patient Dose	9-3
Operator Dose	9-3
Maintaining High Quality Research Scans	9-4
General Patient Scanning Cautions	9-5
Quick Reference Guide - Research/Small Subject	9-6
Scan Procedures	9-7
Checklist	9-7
Preparing the Patient for Scanning	9-7
Update (or Create) the Patient's Record	9-7
Setting the Scan Parameters	9-8
Positioning the Patient/Subject	9-10
Marking the Scan Region	9-11
Starting the Scout Scan	9-12
Starting the Measure Scan	9-14
Analyzing the Scan	9-16
Viewing the Scan Results Tab	9-18
Generate and Print a Report	9-20
A Sample Bone Exam Report - 1 Page	9-22
Scanning Lateral Spine	
Scan Specifications	10-2
Patient Dose	10-3
Operator Dose	10-3
Maintaining High Quality Lateral Spine Scans	10-4
General Patient Scanning Cautions	10-5
Quick Reference Guide - Lateral Spine Scan	10-6
Scan Procedures	10-7
Checklist	10-7
Preparing the Patient for Scanning	10-7
Update (or Create) the Patient's Record	10-7
Setting the Scan Parameters	10-8
Positioning the Patient	10-10
Marking the Scan Region	10-13
Starting the Scout Scan	10-16

Starting the Measure Scan	10-19
Analyzing the Scan	10-21
Viewing the Scan Results Tab	10-24
Generate and Print a Report	10-26
A Sample Bone Exam Report	10-28
Additional Techniques	
Adding Audio to a Patient Record	11-2
Using the Voice Note Option	11-3
How to Record a Voice Note	11-3
How to Play a Voice Note	11-4
How to Delete a Voice Note	11-4
Using the Audio Dictation Option	11-5
Overview of the Audio Dictation Buttons	11-5
How to Record an Audio Dictation	11-5
How to Play Back (or Add to) a Recording	11-6
How to Delete an Audio Dictation	11-7
How to Export a Report to PDF	11-7
FolderMAIL	11-9
Requirements	11-9
How to Send FolderMAIL	11-9
How to Add Names to the Address Book	11-12
How to Import FolderMAIL to a Database	11-13
Database Management	11-14
Creating a Database Folder	11-15
Active Database > Remove From List	11-16
Active Database > Add to List	11-17
Importing a Database	11-18
Exporting a Database	11-20
Deleting Patient Files and Scan Files	11-22
Deleting a Patient File	11-22
Deleting a Patient Visit	11-23
Deleting a Scan Image	11-24
Working with Reference Sets	11-26
To Create a Reference Set	11-27
To Get a Reference Set	11-29
To Edit a Reference Set	11-31
To Delete a Reference Set	11-32
To Send a Reference Set	11-33
To Print a Reference Set	11-34
Reference Set Selection	11-35
Pressing the Emergency Stop Button	11-37
Special Region Cursors	11-38
Number of Special Regions Permitted	11-38
Add a Special Region	11-39
Modify an Existing Special Region	11-41
Delete a Special Region	11-43
Rename a Special Region	11-44
Include/Exclude	11-45
Include	11-45
Exclude	11-49
Using the Ruler Tool	11-52

Comparison Image	11-54
Image Composition and Image Mode	11-56
Analyzing Saved Scan Data	11-59
Reanalyzing Scan Data	11-61
Changing Height or Weight on the Report	11-62
AP Spine Techniques	11-63
Changing the Scan Parameters Prior to Scanning	11-63
Unsatisfactory Measure Scan (AP Spine)	11-64
Auto Centering Mode	11-65
Force Mark Points On-Axis	11-66
Angulated Cursors	11-67
Hip Techniques	11-69
Changing the Scan Parameters Prior to Scanning	11-69
Unsatisfactory Scout Scan (Hip)	11-70
Option 1: Extend the Scout Scan	11-70
Option 2: Reposition the Scout Box and Rescan	11-70
Option 3: Cancel the Scout Scan and Remark	11-70
Alternate R-Value Analysis	11-71
View in the Baseline Mode	11-71
Reanalyze with Alternate R Value	11-72
Forearm Analysis Techniques	11-74
Conversion of Comac Forearm Scans	11-74
Whole Body Scanning Techniques	11-75
Changing the Scan Parameters Prior to Scanning	11-75
Lateral Spine Scanning Techniques	11-76
Changing the Scan Parameters Prior to Scanning	11-76
Unsatisfactory Scout Scan (Lateral Spine)	11-77
Research and Small Subject Techniques	11-78
Changing the Scan Parameters Prior to Scanning	11-78
Ten Year Fracture Risk	
Ten Year Fracture Risk Demographics	12-2
Ten Year Fracture Risk Questionnaire	12-3
Ethnic Group	12-3
Risk Factors	12-3
Ten Year Fracture Risk Confirmation	12-5
Generate and Print a Report	12-6
A Sample Ten Year Fracture Risk Report	12-9
DICOM Interface	
Terms	13-2
Requirements	13-2
Network Address	13-2
OAC Code	13-2
PACS and Worklist Server Setup	13-2
Exploring the DICOM Interface	13-3
How to Invoke the DICOM Interface	13-3
DICOM Preferences Dialog Box: the Site Tab	13-4
The "Site Information" Section	13-4
The "Modality Worklist" Section	13-5
DICOM Preferences Dialog Box: the DICOM Devices Tab	13-6
Advanced Preferences	13-7

Modality Value	13-8
Quick Reference - DICOM Interface	13-9
Patient Worklist	13-9
Exporting and Pushing DICOM Reports	13-9
Patient Worklist	13-10
Query / Cancel	13-11
1. No Results	13-11
2. Error in Query	13-11
3. Query Results Area	13-11
Data Patient Conflict	13-13
Exporting DICOM Images	13-14
Pushing and Deleting DICOM Files	13-15
The Push Operation	13-16
1. No Devices Configured	13-16
2. Single Device Configured	13-16
3. Multiple Devices Configured	13-16
The Delete Operation	13-17
Refresh	13-17
DICOM Job Queue	13-18
DB Extract	
Opening DB Extract	14-2
Selecting Export Parameters	14-3
Source Database	14-3
Patient, Scan, and Region Parameters	14-4
Patient Filtering	14-5
Loading and Saving Setups	14-7
Exporting Data	14-8
Patient Personal and Scan Export Parameters	14-9
General Maintenance	
Routine Maintenance	15-2
Cleaning Scanner Exterior	15-2
Cleaning Table Top Pad	15-2
Cleaning Positioning Aids	15-2
Cleaning QC Phantom	15-2
Preventative Maintenance Schedule	15-2
Quick Reference Guide - System Backup with EaseUS Todo Backup	15-3
Quick Reference Guide - System Backup for Windows 7	15-4
System Maintenance	15-5
Computer Maintenance	15-5
Printer Maintenance	15-5
Corrective Procedures	15-5
Performing Multiple QC Phantom Scans	15-5
Marking the QC Phantom	15-6
Troubleshooting	
Startup	16-2
Startup Faults	16-2
Software Installation Faults	16-2
Scanner Operation	16-3
Software Operation	16-4

Calibration	16-6
Printer	16-7
Reference/Trend Chart Display	16-8
Height and Weight on Reports	16-9
FolderMAIL	16-9
Technical Reference	
Norland Bone Densitometer System Specifications	17-2
DXA System Description	17-2
Electrical Requirements	17-2
Environmental	17-2
X-Ray Detector Assembly	17-2
Scanner Arm Drive	17-2
Laser	17-2
Computer Description	17-2
IMPSO Power	17-2
Expected Useful Life	17-2
Operational Features	17-2
Performance	17-3
Scan Times	17-3
Dose Values	17-3
Spatial Resolution	17-3
Miscellaneous	17-3
Dimensions	17-3
Technical Description	17-4
Significant Zone of Occupancy/Patient Environment	17-4
Focal Spot to Image Receptor Distance (SID)	17-4
X-ray Generator	17-4
Classification	17-4
Cooling Curves & Tube Rating Charts	17-5
Duty Cycle	17-5
Technique (or Loading) Factors	17-5
Electrical Requirements	17-5
Installations	17-5
Service	17-5
FCC EMC Statement	17-6
IEC 60601-1-2 EMC Information	17-6
IEC 60601-1-6 Usability Information	17-10
Usability Characteristics	17-10
Operator Profile	17-10
Fuse Information	17-11
Beam Quality Information	17-11
Position of X-ray Beam	17-12
Cautions	17-13
General Cautions	17-13
Cautions for the Isolated Multiple Portable Socket-Outlet (IMPSO)	17-14
Specific Cautions	17-15
Stray Radiation	17-16
Label Locations	17-17
Scanner Labels	17-19
Controller Certification Label	17-22
Power Entry Module Labels	17-22

Tube Housing and High Voltage Generator Labels	17-22
Reference Data Sets	
Data Collection Sites	18-2
Data Gathering Process	18-2
Medical History Form Review Criteria	18-3
Osteoporosis	18-3
Other Bone-Active Diseases and Conditions	18-3
Medications Affecting Bone	18-4
Statistical Methods	18-5
Reference Sets Data Entry	18-5
WHO Criteria	18-6
Norland Fracture Risk	18-6
Excerpt from Calcified Tissue International	18-7
Excerpt from the Journal of Bone and Mineral Research	18-8
Norland Reference Data Set Values	18-10
NHANES III Reference Data Set Values	18-15
Index	
Quick Reference - AP Spine Scan	
Quick Reference - Hip Scan	
Quick Reference - Whole Body Scan	
Quick Reference - DICOM Interface	
Patient Worklist	Q-4
Exporting and Pushing DICOM Reports	Q-4
Quick Reference - QA Calibration	
Quick Reference - System Backup with EaseUS Todo Backup	

CHAPTER 1

Introduction

Congratulations on purchasing the Norland Elite Dual Energy X-ray Absorptiometry (DXA) Bone Densitometer. Expect the Bone Densitometer to be a valuable aid to the physician in the estimation of bone density and soft tissue, the assessment of fracture risk and trend analysis of patient results.

ISO 13485 Certified: Norland's Quality Management System is certified to ISO 13485:2003. Norland is dedicated to providing a quality product, on time delivery, and exceptional customer service.



Caution: State law requires all scans to be prescribed by a physician.



Caution: Federal law restricts this device to sale by or on the order of a physician.

This chapter discusses the following.

Indications for Use	1-2
X-Ray Device Registration	1-2
Customer Service Contact Information	1-3
About This Manual	1-4
Symbols List	1-6

Indications for Use

The Norland Bone Densitometer is a prescription device used to perform non-invasive estimates of bone mineral density (BMD). It performs DXA scans of the AP Spine, Hip, Lateral Spine, Research, Small Subject, and Whole Body.

The scan provides the BMD (g/cm^2), BMC (g), and the Area (cm^2) values. These values are then compared to gender and ethnic matched reference populations to provide the T-Score, % Young Reference, Z-Score, % Age Matched, and the Short Term and Long Term change values. Included in this calculation is the sBMD (mg/cm^2) values, where applicable.

The Norland Bone Densitometer also performs a soft tissue assessment and provides values for the Lean Mass, Fat Mass, % Total Fat, and the % Soft Tissue Fat for the Whole Body, Research and Small Subject scans. It also provides Siri and Brozek (underwater weighing) % Fat equivalent values.

The bone density measurements from the Norland Bone Densitometer can be an aid to physicians in determining a patient's risk of fractures.

Contraindications



Caution: Do not perform a x-ray bone density scan on a pregnant subject. X-rays may be harmful to developing fetuses.

A bone density study should not be performed within 10 half-lives of a radionuclide uptake procedure. The system detectors may misinterpret residual emissions from recent radionuclide uptake procedures as energy generated by the Norland x-ray source.

Special scanning techniques are required when scanning patients with prosthetic devices, implants, or other sub-dermal metallic objects. Some examples are hip prosthetics, pins, or staples. Refer to the section on "Include/Exclude" on page 11-45 for details.

Scanning patients with external opaque (metal and plastic) objects, jewelry, buttons, zippers, rivets, buckles, pens, keys etc. can affect the results if they are in the scanning region.

X-Ray Device Registration



Caution: The Norland Bone Densitometer is an x-ray device that emits small amounts of radiation to acquire bone and soft tissue information. Although the dose is very small, some countries and all states in the United States require registration of such devices, regardless of dose.

It is the purchaser's responsibility to contact the appropriate government agency and comply with their regulations. Norland's Customer Service can provide assistance in finding the appropriate government agency.

Customer Service Contact Information

All requests for replacement parts, service or product related information should be directed to one of the following worldwide locations. To help the Norland representatives provide prompt and efficient service, please have the serial number of the instrument available. See the figure on page 17-17 (of the Technical Reference chapter) for the label location. The figure on page 17-19 (Scanner Labels) shows the **Identification Label**, which has the instrument serial number on it.

Domestic / North America / Latin America

Norland
W6340 Hackbarth Road
Fort Atkinson, WI 53538 USA

Phone (Toll Free) 1-888-741-0413

Phone (International) +1-920-563-8456

Fax +1-920-542-4274

Email norland@swissray.com



Authorized European Representative

Swissray Medical AG
Turbistrasse 25-27
CH-6280 Hochdorf, Switzerland

Phone +4141 914 1212

Fax +4141 914 1201

Rest of World

Mr. Tom Sanchez
212 Mt. Carmel
Socorro, NM 87801 USA

Phone +1-505-838-0167

Fax +1-505-838-0638



Manufacturer

Norland
W6340 Hackbarth Road
Fort Atkinson, WI 53538 USA

About This Manual

This manual was originally drafted, approved, and supplied in the English language. A copy of this document can be obtained by contacting Norland.

This manual contains information and operating procedures for bone densitometry acquisition and analysis using the Norland DXA Bone Densitometer. The operator should become familiar with the Operator's Guide prior to patient scanning.

The original software disk is located in the back of this manual. Store the software disk in a safe place. Software updates are provided free of charge under initial warranty (12 month period after date of installation) and in conjunction with extended warranty contracts. Installation instructions will accompany any software upgrade.

Chapter 1, Introduction: presents an overview of this Operator's Guide. Customer Service contact information is also included here.

Chapter 2, General Information: discusses some of the features of the Norland DXA Bone Densitometer. System radiation safety precautions and safety features are discussed in detail. (NOTE: additional information on radiation safety is found in the Technical Reference chapter.) The chapter goes on to discuss the system components, which includes the scanner unit, the computer, the windows software, and the accessories. A Quality Assurance program is reviewed. The patient comparison section talks about trend comparison and reference set comparison. The five different Reports are examined: Bone Exam Report; Bone Exam Report - 1 Page; Combined Report; Patients Letter; and the Referral Letter. Print-outs of the sample Reports are also included here.

Chapter 3, Installation and Setup: contains the information for installing and setting up the windows software, drivers, microphone and databases. Next is the login instructions and an intensive examination of the five software menu commands: *File, Edit, Calibration, Tools, and Help*. Scanner and operating settings are made at this time.

Chapter 4, Basic Operation: discusses the basic patient scanning procedure. The steps for starting up the system are next. The daily System Quality Assurance Calibration procedure is discussed in detail as well. The QA results window is analyzed next. The chapter goes on to explain how to prepare a new patient database record, as well as how to edit an existing patient's record. Next, the Patient Demographics window is discussed in detail. And finally, the chapter wraps up with how to back up the system and shut it down.

Chapter 7, Scanning AP Spine and Chapter 8, Scanning Hip: discusses scanning the AP Spine and the Hip. The chapters start out with the scan specifications. Tips on maintaining high quality scans are given next. General patient scanning cautions are given. Next are the actual scan procedures, beginning with the checklist, patient information update, patient positioning procedures, marking the scan region, and starting the actual Measure scan. Scan Analysis and Results are discussed at the end, along with instructions on how to generate and print a Report.

Chapter 10, Scanning Lateral Spine: discusses the scan procedure to estimate bone mineral in the lumbar spine using a lateral projection. The chapter starts out with the scan specifications. Tips on maintaining high quality scans are given next. General patient scanning cautions are given. Next are the actual scan procedures, beginning with the checklist, patient information update, patient positioning procedures, marking the scan region, and starting the actual Measure scan. Scan Analysis and Results are discussed at the end, along with instructions on generating and printing a Report.

Chapter 5, Scanning Whole Body: this option quantifies bone mineral for a subject's entire body. The chapter starts out with the scan specifications. Tips on maintaining high quality scans are given next. General patient scanning cautions are given. Next are the actual scan procedures, beginning with the checklist, patient information update, patient positioning procedures, marking the scan region, and starting the actual Measure scan. Scan Analysis and Results are discussed at the end, along with instructions on generating and printing a Report.

Chapter 9, Research & Small Subject Scan: as options, these two types of scans are very similar, and are therefore combined into one chapter. The Norland software quantifies bone mineral in any user-defined region of a patient or subject anywhere within the scanner's active scanning area. The subject of a Research or Small Subject scan could be human, animal, or an inanimate object. Initial setup, patient/subject positioning, scan

procedures and result analysis are also discussed. Instructions to generate and print a Report are included at the end of the chapter.

Chapter 6, Soft Tissue Composition: this option estimates the lean and fat composition of the soft tissue in the Whole Body, and special regions of Research and Small Subject scans. It works in conjunction with the Whole Body, Research, and Small Subject scans to provide lean and fat soft tissue mass values in addition to the bone density values. The chapter discusses Tissue Composition Standards, Soft Tissue Composition and Results. Instructions to generate and print a Report are included at the end of the chapter.

Chapter 11, Additional Techniques: discusses audio dictation, FolderMail, Special Region Cursors, Include/Exclude, Ruler Tool, Reanalyzing Scan Data, Comparison Image, Analyzing Saved Scan Data and other scan techniques. Database management, as well as Reference Set maintenance is also detailed in this chapter.

Chapter 12, Ten Year Fracture Risk: contains information about generating Ten Year Fracture Risk Assessment reports.

Chapter 13, DICOM Interface: contains information on using this feature. **DICOM** (Digital Imaging and Communications in Medicine) is a global IT standard that is used in hospitals to “control” medical images and derived structured documents as well as to manage related workflow.

Chapter 14, DB Extract: contains information about exporting patient and scan information to a format that can be imported into a spreadsheet or database program.

Chapter 15, General Maintenance: contains routine maintenance information. This typically involves basic cleaning and operational checks. Corrective scan procedures and system maintenance are also detailed in this chapter.

Chapter 16, Troubleshooting: contains basic troubleshooting procedures to assist the operator.

Chapter 17, Technical Reference: contains a Technical Reference guide. Equipment specifications and other regulatory information will be found in this chapter. Labels are discussed in detail.

Chapter 18, Reference Data Sets: contains information about the Norland Reference Data Sets, including the data collection process and criteria. A listing of the values of each Reference Data Set is also included in this chapter.

The **Index** is included at the end of the Operator’s Guide.

Symbols List



Indicates information, general caution or possible safety hazard.



Indicates helpful notes or additional procedure steps.



Indicates radiation from laser positioning aid.

ON/OFF Power Switch

Turn the scanner **ON** and **OFF** by depressing the power switch located on the lower inside right panel.



Figure 1-1: Power Switch location

Scanner Arm Touch Pad Symbols



Figure 1-2: Scanner Touch Pad



The Radiation exposure and arm movement can be terminated, and the system power turned off immediately by the operator at any time by pressing the **EMERGENCY STOP** button located directly below the **Scanner Arm Touch Pad**.



The laser is turned ON and OFF by pressing the **LASER** button on the **Scanner Arm Touch Pad**. When the laser is ON, the indicator next to the button is illuminated yellow.



The **MARK** button is used to identify and mark the scan area.



The **READY** indicator illuminates green to indicate that the x-ray source is energized.



The **X-RAY** indicator illuminates yellow only when the shutter is open and the x-ray beam is accessible. The **X-RAY** indicator extinguishes after the end of a scan when the shutter has closed.



The four arrow buttons are used to manually move the scanner arm and to position it when marking the scan area.

This page intentionally left blank.

CHAPTER 2

General Information

The Norland DXA Bone Densitometer uses a technique known as Dual Energy X-Ray Absorptiometry (DXA) to perform non-invasive estimates of bone mineral density (BMD) in specific regions of the body. The bone density estimates from the Norland DXA system can be used to aid the physician in diagnosing and managing osteoporosis, as well as an aid in assessing risk of fracture.

Information on radiation safety and some of the operational characteristics of the Norland system are on the following pages.

Sample printouts of the reports are included throughout this chapter.

This chapter discusses the following.

Radiation Safety Precautions	2-2
Radiation Safety Features	2-3
Scanner Features	2-3
System Components	2-5
Quality Assurance Program	2-8
Patient Comparison	2-8
Scan Reports	2-12
Sample Scan Reports	2-17
Quality Assurance Reports	2-30

Radiation Safety Precautions

Radiation safety is an important consideration whenever working with x-ray devices. The Norland system emits very little radiation to the patient or scatter radiation to the operator, however certain precautions should be followed to ensure a safe environment for operators and patients.

Stay Out of the Beam

The Norland unit produces a narrow x-ray beam, which cannot be seen or felt, that passes from the x-ray source in the table through the scan subject to the detectors in the scanner arm. Although the Norland x-ray system produces a much lower powered beam in comparison to more traditional x-ray devices, do not expose any part of your body to it unnecessarily. Refer to "Position of X-ray Beam" on page 17-12 in the Technical Reference chapter for a diagram of the x-ray beam location.

Avoid Scatter Radiation

As the beam passes through the patient, some of it is scattered in all directions. This scatter radiation is specified to be less than 0.1 mRem per hour three feet from the beam, and is only present when x-rays are being emitted, such as during the scan. Although this amount of scatter radiation is relatively low, minimize exposure wherever possible. Operators should position themselves three (or more) feet from the scanner whenever the x-ray beam is present.

State Requirements

All states (of the US) have regulations for x-ray devices that apply to the owners of bone densitometers. You are strongly encouraged to contact your state's department of Radiation Control for details.

Control General Access

Whenever possible, the scanner should be placed in a controlled environment that is not accessible by the public. In general, if this is not possible, keep the public at least six feet from the beam during the scan process. State regulations may vary therefore it is important to comply with the specific regulation in your state.



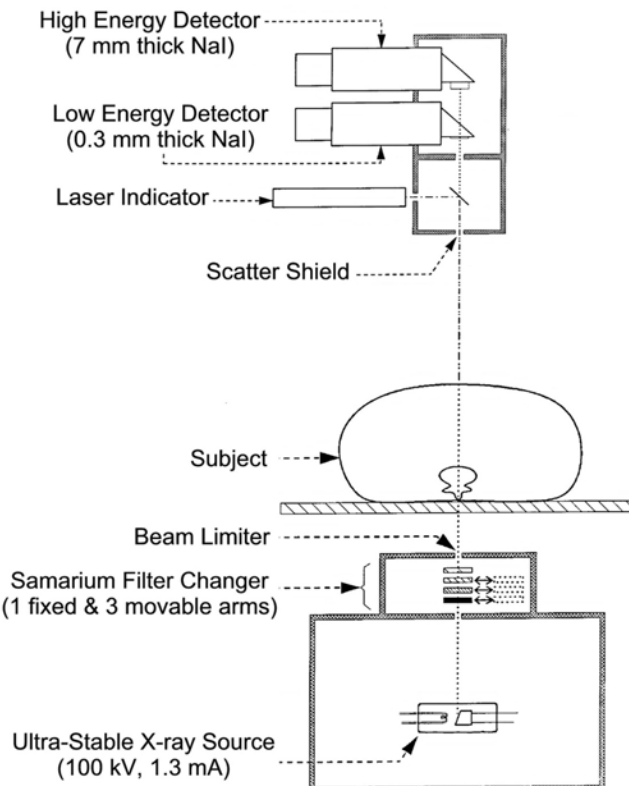

Caution: For patient and operator safety, position the back of the scanner (open area under the tabletop) within a few inches of the wall to prevent unauthorized access to the interior of the device.

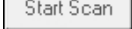

Radiation Safety Features

Exposure Control

The exposure is controlled solely by the operator. The operator must click the  button on the computer screen to initiate the exposure.

The exposure can be terminated by the operator at any time by clicking the  button in the **Scan** tab window, or by pressing the  button directly below the **Scanner Arm Touch Pad**.



Note: TO RESTART: To resume scanning after the **EMERGENCY STOP** button has been pressed, rotate the switch clockwise to release it. Leave the computer power ON to retain the current study. When scanning is resumed, the scanner arm will return to its origin position. **ENSURE THAT THE PATIENT IS NOT IN THE SCANNER ARM PATH!**

Technique Factors

The technique factors (loading factors) are the operating parameters that determine the radiation exposure to the patient. Tube voltage and tube current are fixed, highly regulated, and not subject to line conditions. They are not controlled by the operator. Exposure time depends on the scan type and the size of the scan area.

Communication Watchdog

The Norland scanner includes a 'watchdog' circuit which monitors data collection communication during the scan. If communication fails, the exposure is terminated.

Exposure Indicators

The green **READY** indicator  on the Scanner Arm Touch Pad illuminates to indicate that the x-ray source is energized.

The yellow **X-RAY** indicator  is illuminated only when the beam shutter is open and the x-ray source is energized. The X-RAY indicator extinguishes after the end of a scan when the beam shutter has closed and the beam is not present. **To prevent inadvertent x-ray exposure, the x-ray source will be automatically disabled if the shutter malfunctions.**

Radiation Shielding

System leakage and scatter radiation levels are very low and special shielding is not required. Room shielding is not necessary and the operator does not have to be behind a barrier during the scan. At the typical distance of 3 feet from the beam, the radiation level is <0.1 mRem/hour. Norland recommends that operators position themselves at least three feet from the beam during the scan or as indicated by local state x-ray regulations.

Audible Indicator

An audible indicator sounds at the end of each scan. **DO NOT DISCONNECT** your computer speakers or turn the sound level down too low. FDA regulations require this sound be heard.

Scanner Features

Some of the innovative features used in the Norland system are described in the following sections.

Dual Energy X-Ray Absorptiometry (DXA)

Dual Energy X-ray Absorptiometry (DXA) is a method of estimating bone mineral utilizing a pencil beam x-ray beam filtered to provide the two distinct energy peaks necessary to distinguish bone from soft tissue.

SimulCount™ measures a more accurate measure of BMD. Dual NaI scintillation crystals are used to separately detect the two x-ray energies.

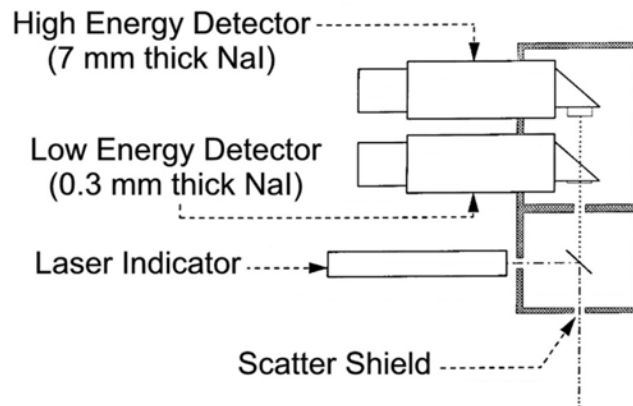

The technique for separating x-ray output into two distinct energy levels is known as K-edge filtration. In K-edge filtering, a rare earth element is placed in the beam path and x-rays are sharply attenuated at energy levels particular to that element. Norland uses samarium as the filter material because it produces energy peaks at 46.8keV and 80keV, which have proven to be most effective at differentiating between soft tissue and bone tissue.

Dynamic Filtering

DynaFlux™ is another Norland innovation that is complementary to its pencil-beam design. Norland has developed a method of optimizing the photon count rate for varying patient thickness by automatically selecting the proper samarium filter combination. This filter selection feature prevents starvation or saturation of the detector assembly.

System Components

The Norland Bone Densitometer consists of a Scanner Unit and a Control/Analysis Computer with a color printer.

Scanner Unit

The Scanner Unit is a specially constructed table that accommodates the patient in a supine position. The tabletop is cushioned and upholstered with a highly durable antimicrobial fabric that can be removed for cleaning. Refer to "Cleaning Scanner Exterior" on page 15-2 and "Cleaning Table Top Pad" on page 15-2 for special instructions.

The radiation source is an x-ray tube with heavy K-edge filtering. The x-ray tube is mounted within a lead-shielded chamber, which has an electrically operated shutter across the beam exit path. The beam is aligned with the detector assembly in the scanner arm. The x-ray source is specially designed for densitometry and has a low operating temperature and long life.



Figure 2-1: Elite Scanner

Scanner Arm Touch Pad

The Scanner Arm contains the **Scanner Arm Touch Pad**. The operator uses the buttons on this touch pad to position the scanner arm directly over anatomical landmarks to define the desired scan area. The up and down arrows move the x-ray source/detector assembly along the X-axis (across the patient table, from front to back). The left and right arrows move the scanner arm along the plane of the patient table (the Y-axis). The **MARK** button is used to identify and mark the scan coordinates for scanning patients and Phantoms. Refer to "Exposure Indicators" on page 2-3 for information on the **READY** and **X-RAY** indicators. Refer to "Exposure Control" on page 2-3 for information on the **Emergency Stop** button. The laser button is discussed in the Laser Positioning Aid section below.



Figure 2-2: Scanner Arm Touch Pad

Laser Positioning Aid

A low-power laser located in the scanner arm indicates the exact position of the x-ray beam. The laser beam is aligned with the narrow x-ray beam in the table and serves as an aid in marking or defining anatomical land-

marks. The laser is turned ON and OFF by pressing the **LASER** button  on the Scanner Arm Touch Pad. When the laser is ON, the indicator next to the laser button is illuminated.

Although it is a low-power laser, the following precautions should be noted:

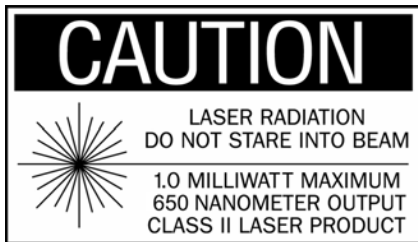

- » Do not stare into the beam.
- » Do not allow the laser to shine into your eyes. If the laser light does briefly shine into your eyes, it may startle you, but will not cause immediate damage.
- » Do not allow shiny objects to reflect laser light into your eyes.

Computer/Controller

The Norland Bone Densitometer is controlled by a desktop PC. The computer is designed and configured to operate the Norland Bone Densitometer system and should not be used for any other purpose. **The computer is certified as an X-Ray Controller at Norland's manufacturing facility, as required by the FDA.**

Software

The Norland Bone Densitometer software conforms to a Windows style design for ease of use and familiarity. Features of the Norland software include menu driven operation for system calibrations, scan data collection, scan analysis and patient file management.

Accessories

The Norland system comes complete with the accessories listed in the next four sections.

QA Calibration Standard

The 77-step QA Calibration Standard (**EmpiriCAL™**) is an exclusive combination of layered plastic and metal material used for system calibration. It is equipped with handles and labeled with characterization values established at the factory.

QC Phantom

The anatomically correct QC Phantom provides an accurate representation of the human spine bone density and soft tissue distribution. Each phantom (unique for each system) has a serial number and includes a label listing the assigned Bone Mineral Density (BMD), Bone Mineral Content (BMC), BMD Standard Deviation (BMD SD), Fat Mass, Fat SD, Lean Mass, and Lean SD values as determined by factory characterization. Refer to "Cleaning QC Phantom" on page 15-2 for special instructions.

Patient Positioning Aids

Patient positioning aids are provided for special positioning of the patient during spine, hip, and lateral procedures.

Table 2-1: Patient Positioning Aids

Positioning Aid	Part Number	Description
Hip Sling	433A134	Used to orient the patient's legs in a position best suited for accurate and precise hip scans.
Leg Separator Block	388D550	Used with hip sling to achieve proper abduction.
Leg Rest Block	433D132	Used to raise the legs to straighten the spine.
Lateral Positioning Blocks *	433A265	Used to properly position the patient's body for a lateral scan. Includes the rib cage support, back rest block, limb blocks, and head support pillow.
* These aids may or may not be included depending on your options.		

Quality Assurance Program

Norland equipment is configured to assist facilities in establishing an effective Quality Assurance Program.

Precision and accuracy of bone mineral density assessments are dependent on an effective Quality Assurance Program.



Norland strongly recommends performing patient scans on the Norland system only after successful completion of the daily Quality Assurance calibration. The calibration compensates for spectral shifts in the x-ray source, slight differences in the interface circuitry and other factors.

Chapter 4, Basic Operation, contains a step by step procedure for performing the daily system quality assurance calibrations. Refer to the "Daily Calibration Procedure" on page 4-6 for details. The procedure consists of:

- » scanner stabilization
- » parts damage check and positioning
- » a scan of the QA Calibration Standard
- » a scan of the QC Phantom
- » diagnostic tests
- » and calibration verification

Once the calibration routine is initiated, it proceeds automatically until all data is collected and the results of the QA Calibration Standard and the QC Phantom scans are displayed.

QA results should be printed and kept in a paper log file for quick reference.

Norland software will automatically display an **Alert** pop-up dialog box when more than 24 hours has elapsed since the last calibration. Norland strongly recommends performing a daily calibration before scanning patients. Sample pop-up:

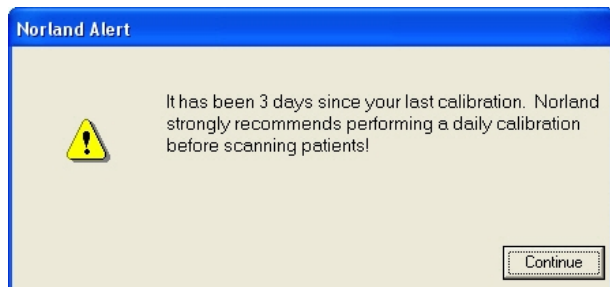

Figure 2-3: QA Alert pop-up

It is not necessary to calibrate the system on a day that the Norland Bone Densitometer will not be used to scan patients.

Patient Comparison

Patient scan results are compared to reference populations or to previous scans for comparisons for diagnosis. Much has been written on the use of bone mineral analysis techniques.^{a b c}

^aRoss, P. D., Davis, J. W. Vogel, J. M., and Wasnich, R. D.: "A Critical Review of Bone Mass and the Risk of Fractures in Osteoporosis". Calcified Tissue International 46:149-161, 1990.

^bMelton III, J. L., Eddy, D. M., Johnson Jr., C. C.: "Screening for Osteoporosis". Annals of Internal Medicine. 112:516-528, 1990.

^c"Assessment of Fracture Risk and its Application for Postmenopausal Osteoporosis", WHO Technical Reports Series, No. 843.

Trend Comparison

Assessment of the rate of change in bone mineral density provides the clinician with the best information regarding whether the patient is losing or gaining bone mineral. If previous assessments have been made of the patient, the current assessment may be compared with past scans to determine the rate of change.

Statistical reasoning is required to interpret scan results. Differences in two serial assessments of a patient that are close in value could simply be due to random variation. In order to have 95% confidence ($p < 0.05$) that a change in value represents a change in actual BMD, the change must be at least:

$$2\sqrt{2} \times \frac{\text{C.V.}}{100} \times \text{BMD value}$$

The above equation would be valid for two scans of the same anatomical site on one patient from the same Norland unit. The Coefficients of Variation (C.V.) furnished for each measurement type are valid for subjects having well defined bones and non-calcified soft tissue. The following table shows an example of the above equation using manufacturer C.V. values.

AP Spine Change	Femoral Neck Change
C.V. of 0.9% ^a	C.V. of 1.4% ^b
If the first value is 1.0 g/cm ² then change must be 0.025g/cm ² .	If the first value is 1.0 g/cm ² then change must be 0.039 g/cm ² .



Note: C.V.'s for individual facilities may be different from manufacturer specified C.V.'s, depending on operator technique and experience.

Precision

Precision is the degree to which the same value is obtained when a measurement is repeated. *In vivo* precision in the Norland Bone Densitometer is the degree to which the device presents the same bone mineral value when a measurement is repeated at the same anatomical site on the same subject.

Factors affecting precision are:

- » inherent instrumentation errors
- » operator technique
- » the *in vivo* nature of the measurement

All precision specifications given in this guide and on the Norland outputs assume:

- » a properly operating instrument
- » a stationary scan subject
- » an experienced operator
- » proper and consistent positioning and analysis techniques

Precision can be improved by averaging a number of repeated measurements. Then the precision of the mean value is improved by a factor of the square root of the number of measurements. This technique is used with phantoms for evaluating instrument accuracy.

^aAs specified in Table 7-2, on page 7-2.

^bAs specified in Table 8-2, on page 8-2.

Accuracy

Accuracy is the degree to which a measurement value reproduces the actual value of the quantity being measured.

Although the accuracy of a single measurement includes the imprecision of that measurement, it is customary to specify instrumental accuracy with the imprecision effect removed. This is called “accuracy of the mean” because taking the mean or average of many measurements minimizes the imprecision. The accuracy specifications for the Norland Bone Densitometer are stated in terms of accuracy of the mean.

Several manufacturers have adopted phantoms fabricated of calcium hydroxyapatite and epoxy. The calibration of each Norland instrument is based on hydroxyapatite phantoms constructed to specifications described by White (White, D. R., Martin, R.J., and Darlinson, R.: “Epoxy resin based tissue substitutes.” Brit. J. Radiol. 50, 814-821, 1977).

Standard Deviation (S.D.)

Standard Deviation is used to specify precision. In a normal (or bell-curve) distribution, 68% of all the estimations lie within one standard deviation of the mean, and 95% of all measurements lie within two standard deviations of the mean.

Coefficient of Variation (C.V.)

Coefficient of Variation is used to specify precision. It is the standard deviation expressed as a percent of the measured quantity. The coefficient of variation is the standard deviation divided by the mean.

Reference Set Comparison

The patient's Bone Mineral Density (BMD) estimate can be compared to a reference population that is clinically free of bone disease and matches the patient's gender, ethnic background, and age. This variance of the patient's BMD value relative to the mean of the reference population is graphed and expressed as a standard deviation. Norland software contains many reference sets for comparisons and facilities can create their own reference sets based on local populations.

Reference Set upgrades are provided free of charge and are usually distributed as they become available.

Reference sets are displayed as a chart containing the average BMD value of the reference population for the prescribed anatomy. Many reference charts are color coded to assist with Fracture Risk Assessment. A sample chart is displayed in Figure 2-4.

The middle line represents the average value for BMD for the ages included in the chart. The dashed lines above and below the middle line are (+2) and (-2) standard deviations from the mean value.

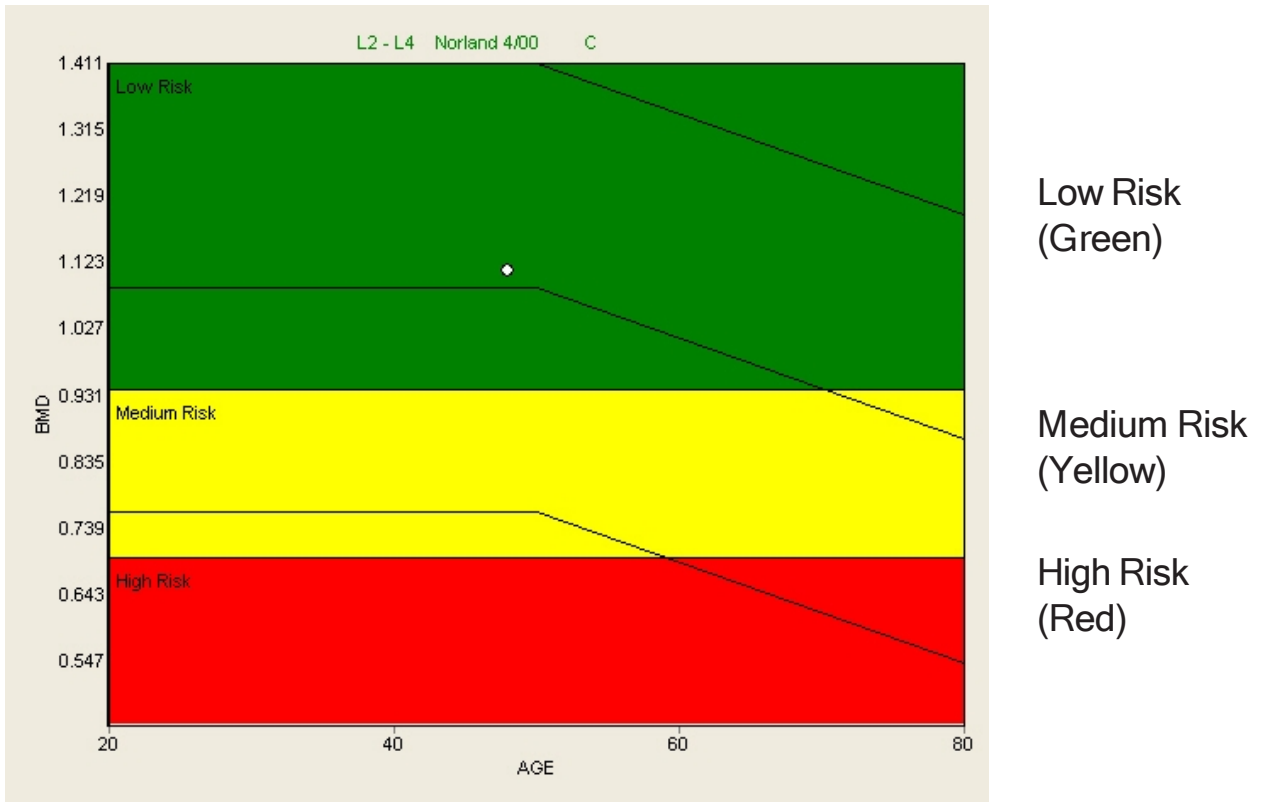

Figure 2-4: Fracture Risk Reference Set Chart (sample)

Norland incorporates the WHO (World Health Organization) criteria in plotting a patient's fracture risk assessment (see table below).

Table 2-2: World Health Organization Risk Factor Criteria

<p>Low Risk (Green)</p>	<p>Represents the range of values determined by WHO to be 'normal' (having adequate bone mineral). The BMD T-Score values in this region are within 1 SD of the young adult reference mean value. A patient whose value is plotted in this region has no identifiable risk of fracture.</p>
<p>Medium Risk (Yellow)</p>	<p>Represents the range of values determined by WHO to be 'osteopenic' (having low bone mineral). The BMD T-Score values in this region range are more than 1 SD below the young adult mean value but less than 2.5 SD below the mean value. A patient whose value is plotted in this region may be developing a tendency to fracture.</p>
<p>High Risk (Red)</p>	<p>Represents the range of values determined by WHO to be 'osteoporotic' (having severely reduced bone mineral). The BMD T-Score values in this region are more than 2.5 SD below the young adult mean. A patient whose value is plotted in this region has a high spontaneous fracture probability.</p>

Scan Reports

Five different types of Reports can be generated for each scan: the *Bone Exam Report*, the *Bone Exam Report - 1 Page*, the *Combined Report*, the *Patient Letter*, and the *Referral Letter*. In addition, the *Ten Year Fracture Risk Report* can be generated for Hip Scans (if enabled), and the *Body Composition Report* can be generated for Whole Body Scans (if enabled). The next section discusses how to generate these Reports. A discussion of each Report is also included in this chapter with a sample of each for reference.

Generating a Report

Reports may be generated two different ways:

Follow these steps to generate a Report from Scan Results:

After a scan has been performed, analyzed, and saved, click  to generate a report using the currently selected report template.

Follow these steps to generate a Report from Stamp View or Filmstrip View:

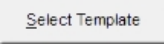
1. Make sure that the scanned image is being viewed as a thumbnail in the **Stamp View** or the **Filmstrip View**. Click (to highlight) the thumbnail view of the scan.
2. Click **Tools > Report > Select Template...** or click the  button to open the "Report Configuration" dialog box.

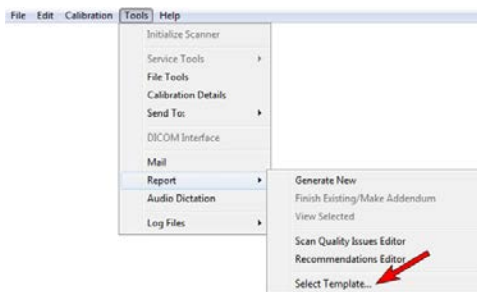

3. When the **Report Configuration** dialog box opens, click a Report Template to highlight it (*Bone Exam Report - 1 Page* was selected here). See "Sample Scan Reports" on page 2-17 for examples of the report template selections. Click .

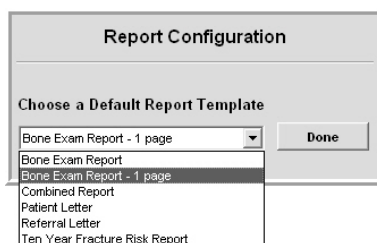

Note: The selected Report Template will remain the default until it is changed. The currently selected Report Template is always displayed at the bottom of the IlluminatusDXA window.

4. Click **Tools > Report > Generate New** or click the  button.

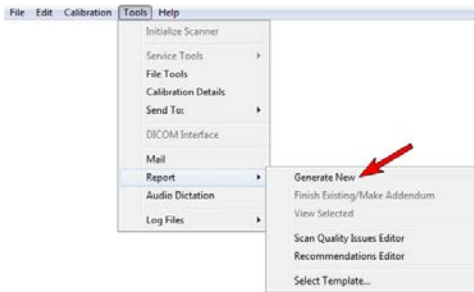

- The Report is immediately generated and opens up in the window, as shown. At this point, the operator can type in their comments and recommendations, *Lock* it, *Save* it, *Print* it, *Export* it to a PDF file (or a DICOM file) and *Close* it.

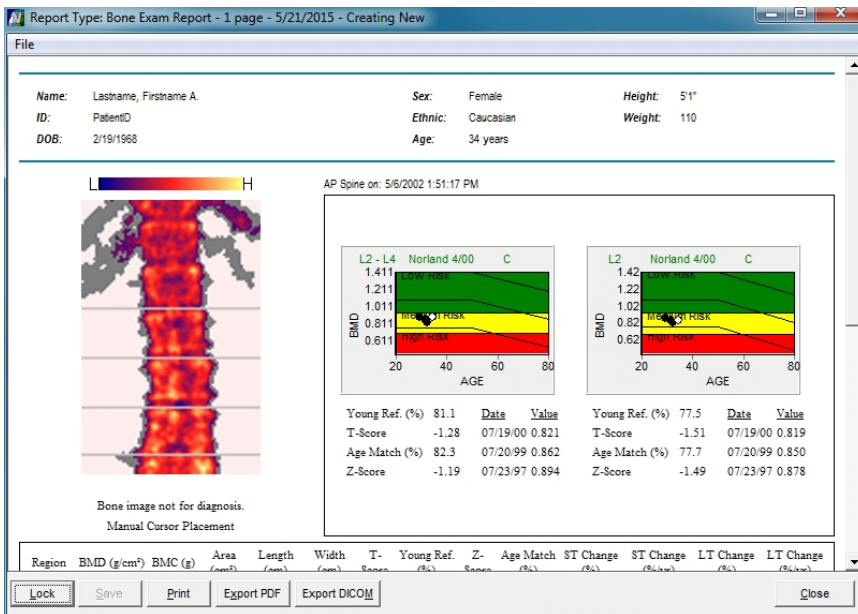

The buttons and their functions are explained next.

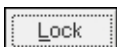

: Click to lock a report, which prevents it from being deleted. It can still be edited.



: Click to save a report without printing. It will appear on the **Reports** tab.



: Click to automatically save and print a report.

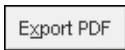

: Click to create and save the report in a PDF format. Browse to the appropriate directory, type in a file name and click . Click .



: Click to create a DICOM compatible report (active only when DICOM option is enabled).

When done reviewing the Report, click and then . The Report is saved, attached to the scan, and a new tab is created - called **Reports**.

The “Reports” Tab

As mentioned previously, once a Report is generated and saved, it can be viewed from the “Reports” tab. It can be modified, viewed and re-printed at any time.

1. From the Stamp view, click the **Reports** tab to see the Report list (shown here).

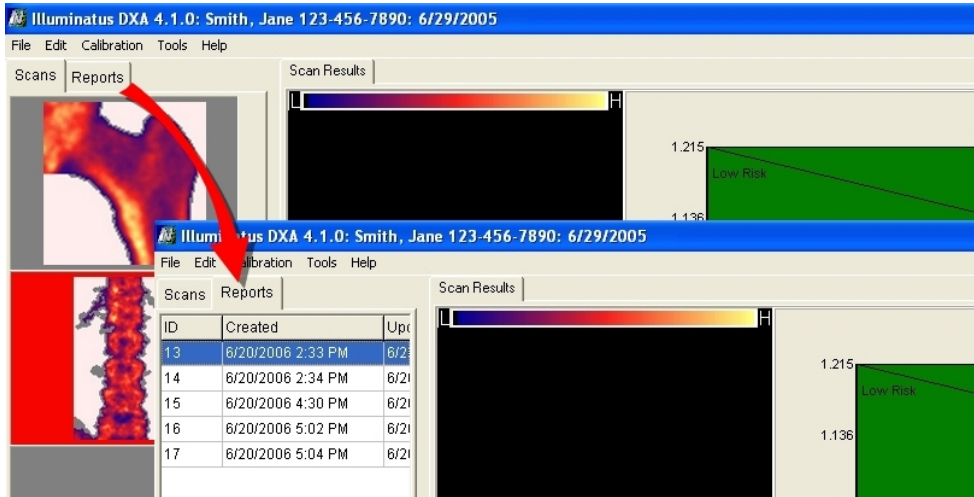

2. Click (at the bottom of the Reports tab window) to view the entire report list at once.

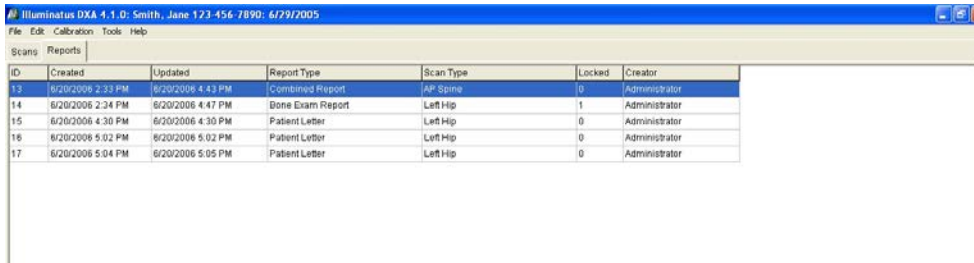

All of the Reports generated will appear in this list along with the date they were created. Double clicking on any of the Report names will open the Report for viewing.

- » To **view** and **print** any saved Report, double-click on it.
- » To **delete** a Report, click on the Report to select it. Press **<Ctrl>+<Delete>**. (NOTE: a locked Report cannot be deleted.) When the “Confirm” pop-up appears, click .

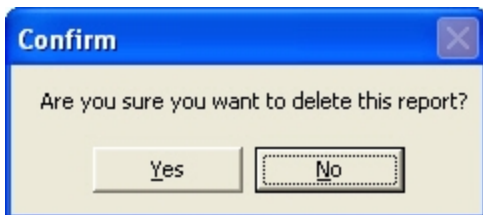

- » To **modify** a Report that is not locked, click on **Tools > Report > Complete Report** to open it.

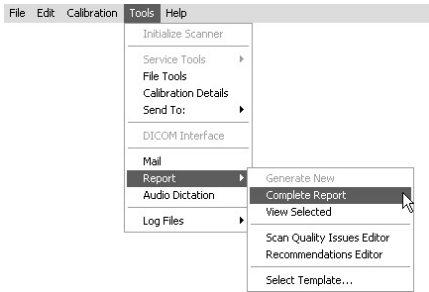

» To modify a locked Report, click on **Tools > Report > Make Addendum**. Make any edits to the Comments field as necessary. Click **Save**, then **Close**.

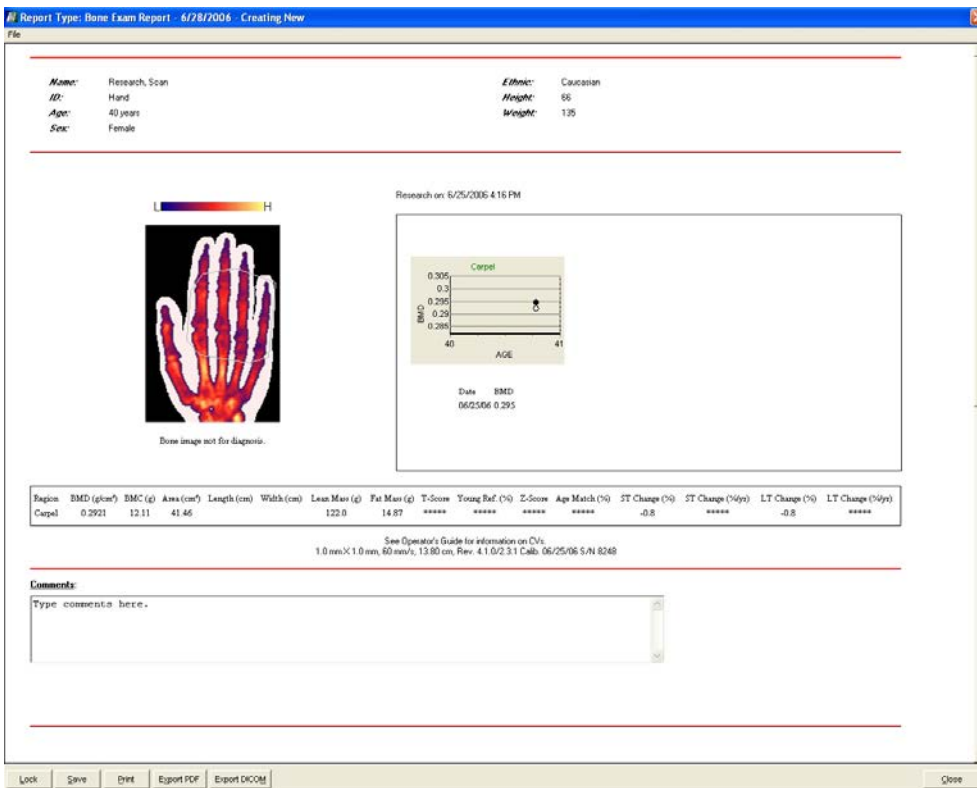
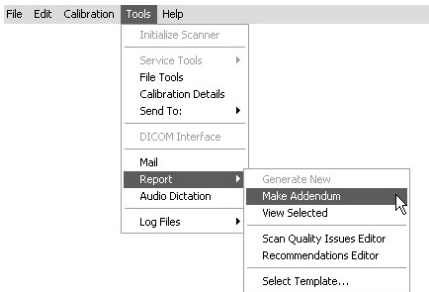

Editing the Patient Letter or Referral Letter

The information from Bone History and Osteoporosis Medication fields in the Demographics screen will be listed in the Referral Letter.

Scan Quality Issues and Recommendations can be added to either report using a checklist.

» To edit the Scan Quality Issues checklist click on **Tools > Report > Scan Quality Issues Editor**.

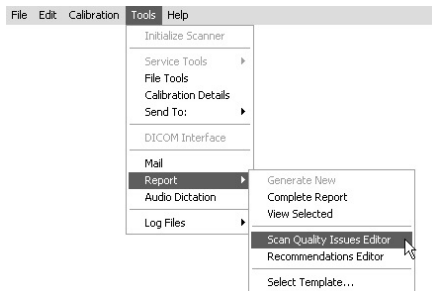

» To edit the Recommendations checklist click on **Tools > Report > Recommendations Editor**.

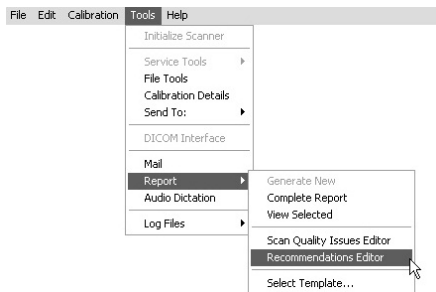

» Create a new entry by entering the information in the first line of the dialog box.

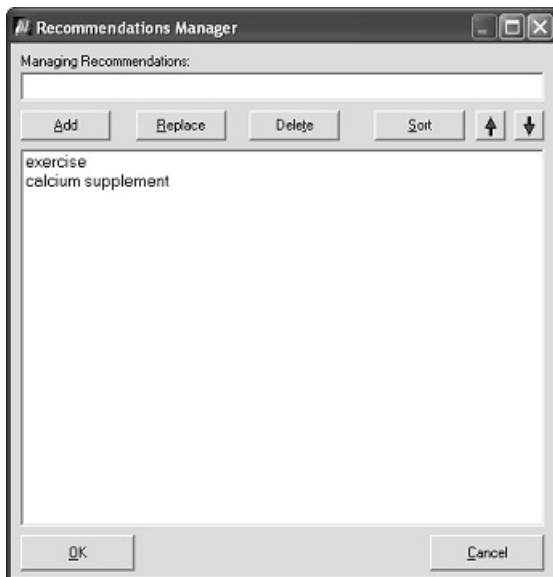

» Click . Click . It will now be included in the drop-down list as a selection.

Sample Scan Reports

The Bone Exam Report

The results of the Analysis function include image displays, graphical displays and numeric information and are typically printed as a two page report. This report is referred to as the “**Bone Exam Report**”. An example of a Bone Exam Report is included in this section.

The first page of the *Bone Exam Report* displays the basic patient information (as entered in the Patient Demographics window by the operator when preparing the patient record).

Next, the Report includes an image of the scanned region. The BMD is displayed in chart form to the right.

Following the graphs, the BMD, BMC, and Area quantities are displayed in numeric terms in the form of a table. Quantities of bone mass are reported as Bone Mineral Density (BMD), Bone Mineral Content (BMC), and Area. The BMD is BMC divided by Area, and is expressed in milligrams per square centimeter.

This complete table includes the scan data, reference and/or trend information for the measured region(s), and basic scan conditions. Detailed numeric results for the region(s) scanned are displayed here. The T-Score and Z-Score values are displayed in the table, as well.

The last line of the table in the Report (for AP Spine and the Hip scans only) includes the Total sBMD report. The units are in mg/cm² for the region of interest. Quantities of bone mass are reported as Bone Mineral Density (BMD), Bone Mineral Content (BMC), and Area. The BMD is BMC divided by Area, and is expressed in grams per square centimeter. The Committee for Standards in DXA instituted correlation equations for AP Spine (1995) and Hip (1997).

Whole Body scans (an option) additionally provide the lean and fat composition of the soft tissue (presented in grams). Total body fat percent and underwater weighing equivalents are also displayed.

Furthermore, sBMD and NHANES III is only used for female Caucasian Total Hip Scans. The sBMD (standard Bone Mineral Density) values provide the physician with T-score and Z-score results for the total Hip scans that are derived from accepted reference data sets, including NHANES III. More detail about this topic may be found in the Reference Data Sets chapter.

Next, a “Comments” area is located at the bottom of page 1. This part of the Report is a text entry area that is filled in when the Report is generated. Once a Report is saved, the comments fields can be added to or changed later by Text can also be added (or changed) later by selecting **Tools > Report > Complete Report** and then entering the text.

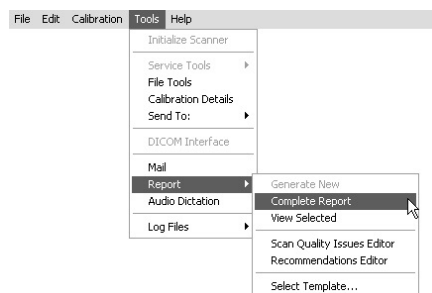

The second page of the Bone Exam Report contains all of the patient personal data and specific scan parameter information. This includes scan type, resolution, and speed. It also contains the reference and trending charts and specific data. The text entered in the “Comments” portion of the Patient Demographics window prints out below the patient personal data.

1: A Sample “Bone Exam Report”

A sample 2-page Bone Exam Report is included here for reference.

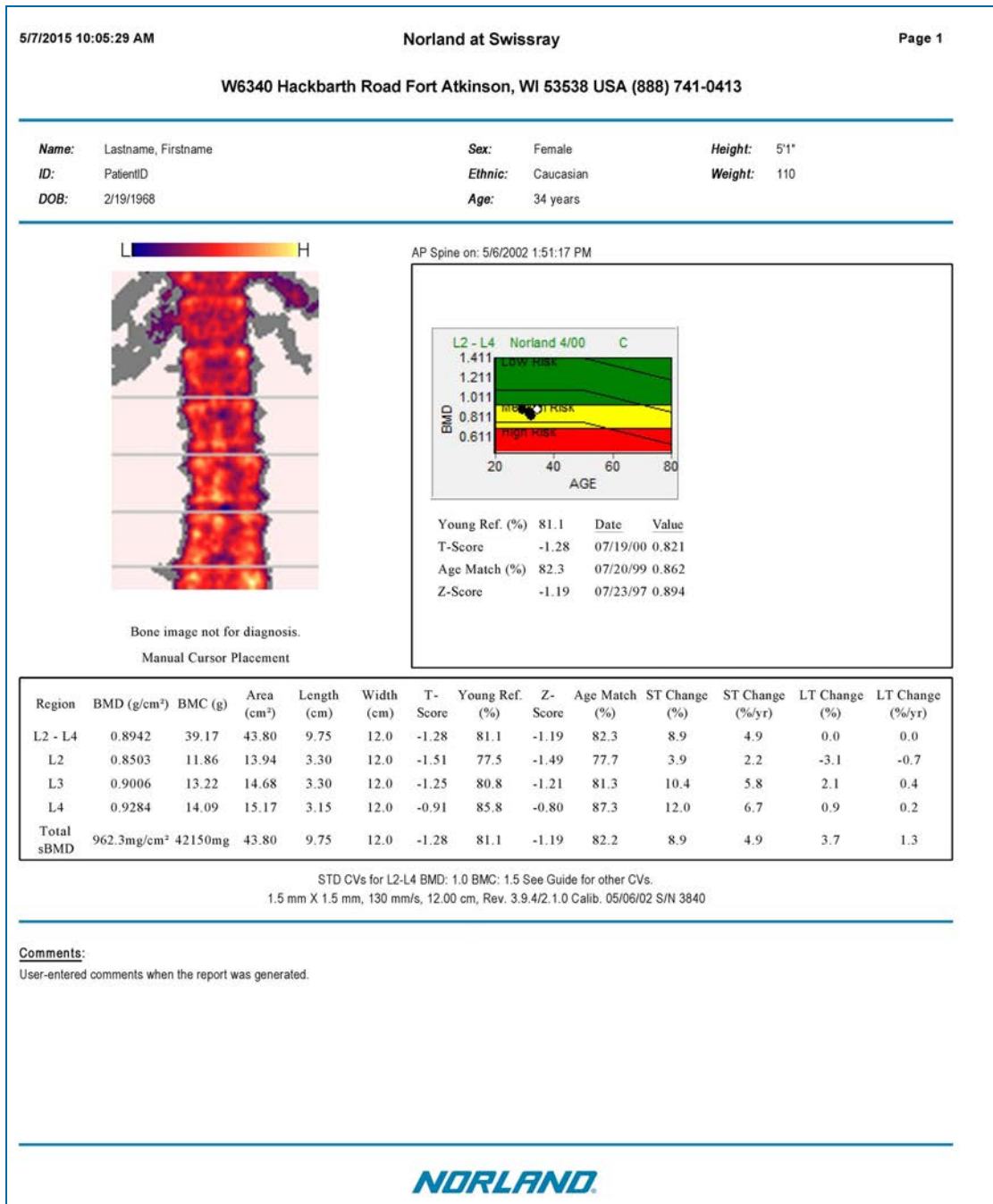

Figure 2-5: Page 1 of the Bone Exam Report



Figure 2-6: Page 2 of the Bone Exam Report

2: A Sample “Bone Exam Report - 1 Page”

The information from the 2-page Bone Exam Report is condensed down to form this **one page** report, with basic patient information and reference graphs for all regions of interest, as shown next:

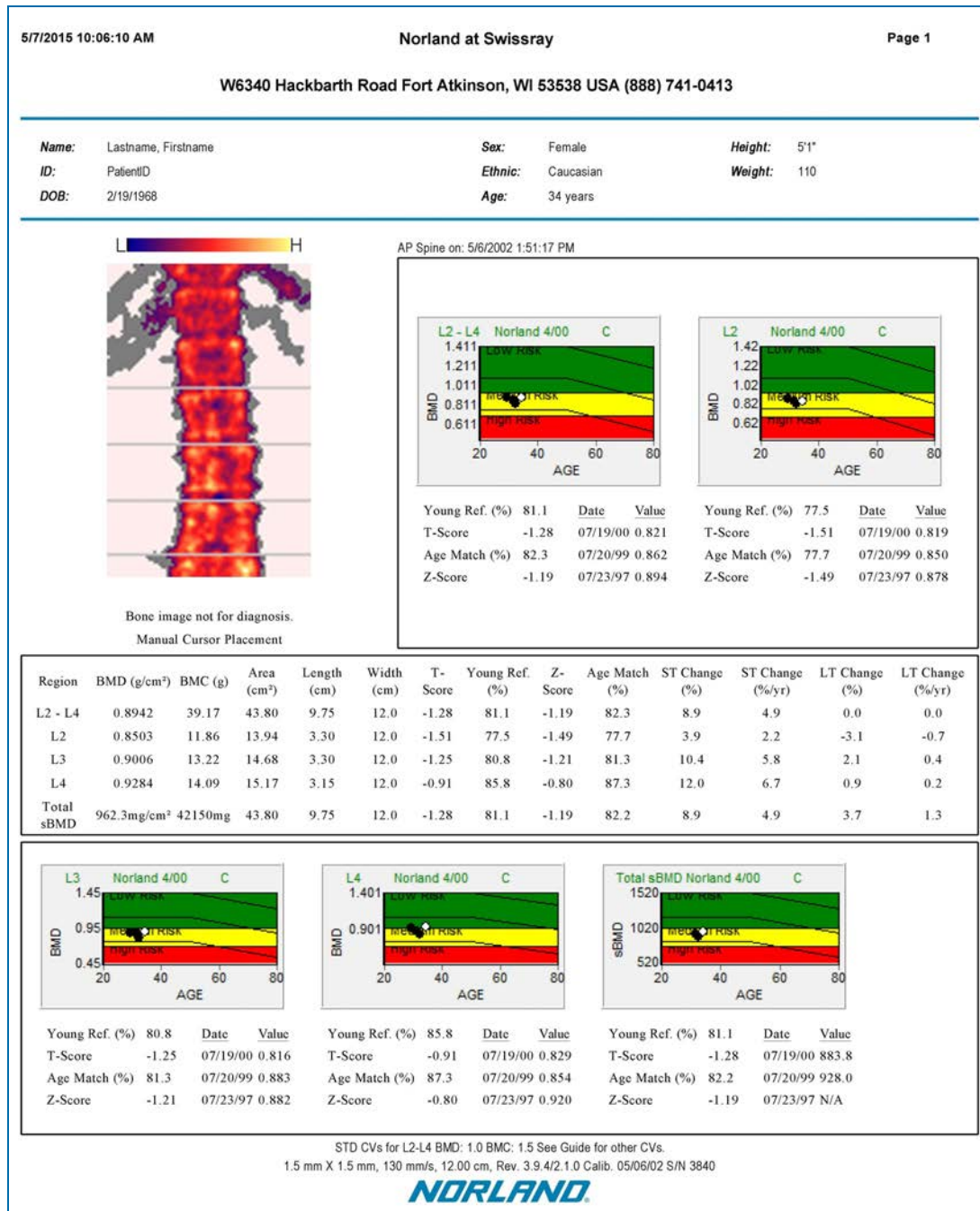

Figure 2-7: The Bone Exam Report - 1 Page

3: A Sample “Combined Report”

The physician has the option to combine the results of two different bone scans of a single visit into a one page **Combined Report**, as shown next:

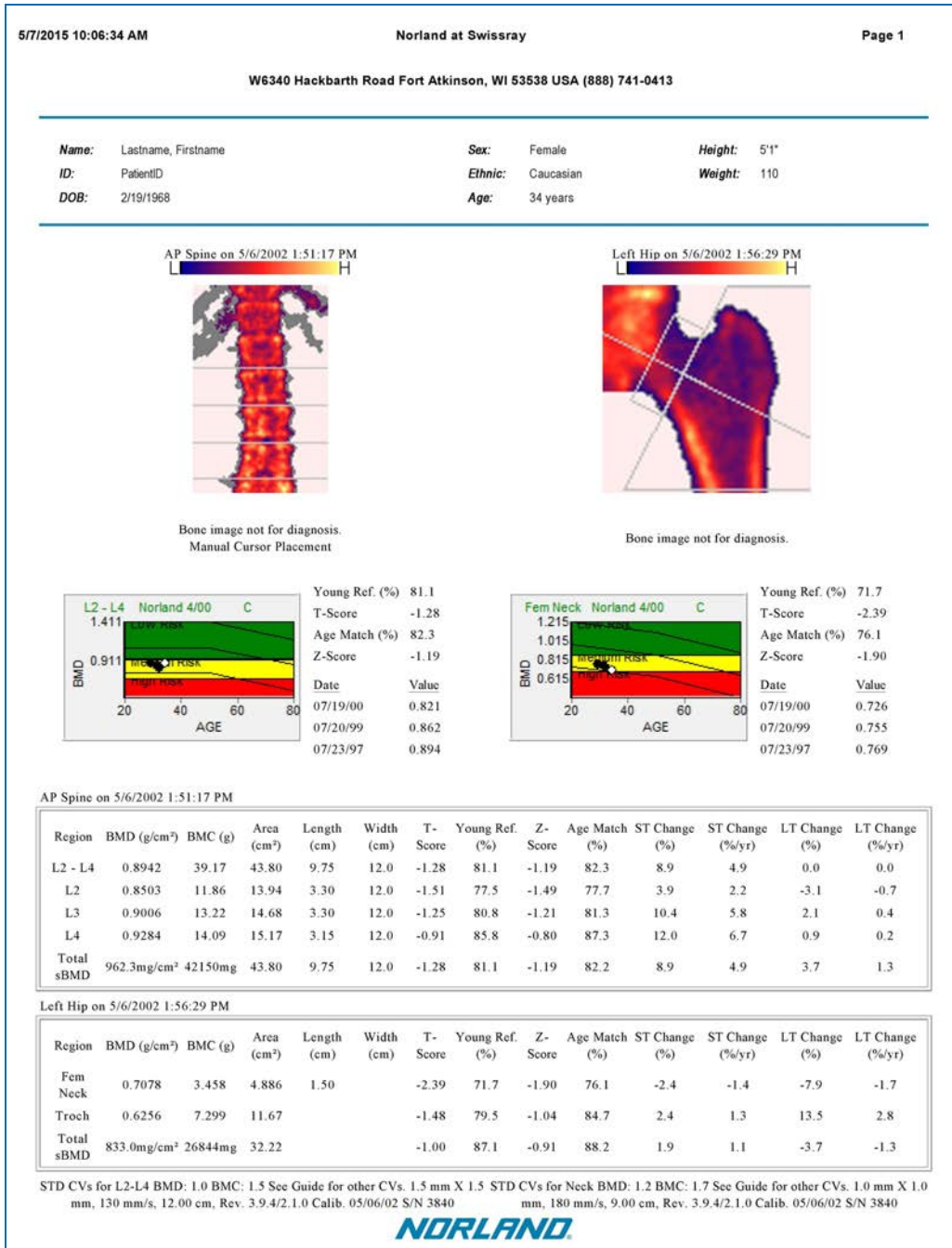

Figure 2-8: The Combined Report

4: A Sample “Patient Letter”

The **Patient Letter** is a 2 or 3 page Report that is sent to a patient from the primary physician. Patient Letters can be generated for a single scan or a combination of two different scans from the same visit. “Scan Quality Issues” and “Recommendations” can be selected from a checklist.

Norland at Swissray

W6340 Hackbarth Road Fort Atkinson, WI 53538 USA (888) 741-0413

Patient Report -- Bone Density Test

Patient Name:	Lastname, Firstname	Patient ID:	PatientID
DOB:	2/19/1968	Gender:	Female
Age:	34 years	Referred By:	
Test Date:	5/6/2002 1:56:29 PM		

Dear Firstname Lastname,
This is the result of your recent Bone Density Test.

AP Spine on 5/6/2002 1:51:17 PM

	L2 - L4	L2	L3	L4
Density (g/cm) ²	0.8942	0.8503	0.9006	0.9284
T-Score	-1.28	-1.51	-1.25	-0.91
Z-Score	-1.19	-1.49	-1.21	-0.80

Left Hip on 5/6/2002 1:56:29 PM

	Fem Neck	Troch	Total sBMD
Density (g/cm) ²	0.7078	0.6256	833.0mg/cm ²
T-Score	-2.39	-1.48	-1.00
Z-Score	-1.90	-1.04	-0.91

<p>BMD COMPARISON</p> <table border="1" style="width: 100%; border-collapse: collapse;"> <thead> <tr> <th>Scan</th> <th>Date</th> <th>BMD</th> <th>Change</th> <th>Baseline</th> </tr> </thead> <tbody> <tr> <td>1</td> <td>07/23/97</td> <td>0.769g/cm²</td> <td></td> <td></td> </tr> <tr> <td>2</td> <td>07/20/99</td> <td>0.755g/cm²</td> <td>-0.013g/cm²(-1.7%)</td> <td>-0.013g/cm²(-1.7%)</td> </tr> <tr> <td>3</td> <td>07/19/00</td> <td>0.726g/cm²</td> <td>-0.030g/cm²(-4.0%)</td> <td>-0.043g/cm²(-5.6%)</td> </tr> <tr> <td>4</td> <td>05/06/02</td> <td>0.708g/cm²</td> <td>-0.018g/cm²(-2.4%)</td> <td>-0.061g/cm²(-7.9%)</td> </tr> </tbody> </table>	Scan	Date	BMD	Change	Baseline	1	07/23/97	0.769g/cm ²			2	07/20/99	0.755g/cm ²	-0.013g/cm ² (-1.7%)	-0.013g/cm ² (-1.7%)	3	07/19/00	0.726g/cm ²	-0.030g/cm ² (-4.0%)	-0.043g/cm ² (-5.6%)	4	05/06/02	0.708g/cm ²	-0.018g/cm ² (-2.4%)	-0.061g/cm ² (-7.9%)	
Scan	Date	BMD	Change	Baseline																						
1	07/23/97	0.769g/cm ²																								
2	07/20/99	0.755g/cm ²	-0.013g/cm ² (-1.7%)	-0.013g/cm ² (-1.7%)																						
3	07/19/00	0.726g/cm ²	-0.030g/cm ² (-4.0%)	-0.043g/cm ² (-5.6%)																						
4	05/06/02	0.708g/cm ²	-0.018g/cm ² (-2.4%)	-0.061g/cm ² (-7.9%)																						

Given the documented precision of these studies, changes that exceed the limit of Least Significant Change of 0.029g/cm² (4.0%) may indicate a significant change between the studies being compared.

Figure 2-9: Page 1 of the Patient Letter

Norland at Swissray**W6340 Hackbarth Road Fort Atkinson, WI 53538 USA (888) 741-0413**

Your test was performed using the Norland DXA Bone Densitometer, serial number 3840. This system uses the industry standard dual energy x-ray absorptiometry (DXA) technique to estimate your bone density non-invasively. Your test includes values called the T-score and the Z-score. The T-score compares the current study to bone density of a young healthy population and the Z-score compares the current study to an age and gender matched reference population.

Your T-score can be evaluated according to the criterion established by the World Health Organization (WHO) as follows:

If your T-score is:	You may be:
-1 or above	Normal (adequate bone density)
between -1 and -2.5	Osteopenic (reduced bone density)
below -2.5	Osteoporotic (severely reduced bone density)

The WHO criterion are especially useful when assessing the condition of postmenopausal women, men over 65 years of age and men between 50 and 65 years of age with risk factors that may lead to excessive bone loss.

Although very useful, this test is not the sole determinant of your bone health. There are other factors to consider, which we can discuss if you wish. Examples of other risk factors for bone loss which need to be considered in a general assessment include genetic influences such as a family history of osteoporosis, environmental factors which may originate from nutrition or physical activity, the influence of endogenous hormones or chronic disease, failure to achieve peak bone mass in youth and a history of excessive aging related bone loss.

In reviewing your Bone Density Test, my specific recommendations are:

A follow-up consultation for this test within 2 months.

A repeat Bone Density Test in 24 months.

Further recommendations include exercise and calcium supplement.

Finally, a review of this study indicates that skeletal damage may technically limit the usefulness of these study interpretations.

Please feel free to call with any questions you may have.

Sincerely,

Figure 2-10: *Page 2 of the Patient Letter:*

5: A Sample “Referral Letter”

The **Referral Letter** is a 2 or 3 page Report sent to the referring physician from the facility that did the scan. Referral Letters can be generated for a single scan or a combination of two different scans from the same visit. “Scan Quality Issues” and “Recommendations” can be selected from a checklist.

Norland at Swissray

W6340 Hackbarth Road Fort Atkinson, WI 53538 USA (888) 741-0413

Referral Report -- Bone Density Test

Patient Name:	Lastname, Firstname	Patient ID:	PatientID
DOB:	2/19/1968	Gender:	Female
Age:	34 years	Referred By:	
Test Date:	5/6/2002 1:56:29 PM		
Address:			

Dear ,

Thank you for referring Firstname Lastname to our practice. Our records indicate a history of non-traumatic bone fracture and primary osteoporosis. This patient indicates usage of the following medications: Actonel, Fosamax and Vitamin D.

The results of the Bone Density Test performed on Firstname Lastname are as follows:

AP Spine on 5/6/2002 1:51:17 PM

	L2 - L4	L2	L3	L4
Density (g/cm) ²	0.8942	0.8503	0.9006	0.9284
T-Score	-1.28	-1.51	-1.25	-0.91
Z-Score	-1.19	-1.49	-1.21	-0.80

Left Hip on 5/6/2002 1:56:29 PM

	Fem Neck	Troch	Total sBMD
Density (g/cm) ²	0.7078	0.6256	833.0mg/cm ²
T-Score	-2.39	-1.48	-1.00
Z-Score	-1.90	-1.04	-0.91

BMD COMPARISON				
Scan	Date	BMD	Change	Baseline
1	07/23/97	0.769g/cm ²		
2	07/20/99	0.755g/cm ²	-0.013g/cm ² (-1.7%)	-0.013g/cm ² (-1.7%)
3	07/19/00	0.726g/cm ²	-0.030g/cm ² (-4.0%)	-0.043g/cm ² (-5.6%)
4	05/06/02	0.708g/cm ²	-0.018g/cm ² (-2.4%)	-0.061g/cm ² (-7.9%)

Given the documented precision of these studies, changes that exceed the limit of Least Significant Change of 0.029g/cm² (4.0%) may indicate a significant change between the studies being compared.

Figure 2-11: Page 1 of the Referral Letter

Norland at Swissray**W6340 Hackbarth Road Fort Atkinson, WI 53538 USA (888) 741-0413**

This test was performed using the Norland DXA Bone Densitometer, serial number 3840. This system uses the industry standard dual energy x-ray absorptiometry (DXA) technique to estimate bone density non-invasively. This test includes values called the T-score and the Z-score. The T-score compares the current study to bone density of a young healthy population and the Z-score compares the current study to an age and gender matched reference population. The T-score can be evaluated according to the criterion established by the World Health Organization (WHO) as follows:

If the T-score is:	The subject may be:
-1 or above	Normal (adequate bone density)
between -1 and -2.5	Osteopenic (reduced bone density)
below -2.5	Osteoporotic (severely reduced bone density)

The WHO criterion are especially useful when assessing the condition of postmenopausal women, men over 65 years of age and men between 50 and 65 years of age with risk factors that may lead to excessive bone loss.

Although very useful, this test is not the sole determinant of bone health. There are other risk factors which need to be considered in a general assessment such as a family history of osteoporosis, environmental factors which may originate from nutrition or physical activity, the influence of endogenous hormones or chronic disease, failure to achieve peak bone mass in youth and a history of excessive aging related bone loss.

In reviewing this Bone Density Test, my specific recommendations are:

That you explain these test results to your patient in light of their overall medical history.

Perform a repeat Bone Density Test in 2 months.

Further recommendations include exercise and calcium supplement.

Finally, a review of this study indicates that patient positioning may technically limit the usefulness of these study interpretations.

Please feel free to call with any questions you may have.

Sincerely,

Figure 2-12: Page 2 of the Referral Letter

6: A Sample “Ten Year Fracture Risk Report”

A **Ten Year Fracture Risk Report** assess the patient's probability of a future fracture. This report can only be generated for hip scans and is only available when the Ten Year Fracture Risk option is enabled.

Norland at Swissray

W6340 Hackbarth Road Fort Atkinson, WI 53538 USA (888) 741-0413

Ten-Year Fracture Risk Report

Patient Name:	*Hip.good left	Patient ID:	Left Hip
DOB:	11/9/1926	Gender:	Female
Age:	68 years	Referred By:	
Test Date:	11/6/1995		

On 11/6/1995, left *Hip.good underwent a DXA-based analysis using the Norland DXA Bone Densitometer, serial number 6746. The DXA-study included a study of the proximal femur allowing a Ten-Year Fracture Risk Analysis. The Ten-Year Fracture Risk Analysis is based on research carried out by the World Health Organization allowing a review of the patient's sex, age, Femur Neck T-score and a review of risk factors known to relate to Fracture Risk to arrive at a population based estimate of a Ten-Year Hip Fracture Risk.

While evaluating left *Hip.good we were able to establish that she has a history consistent with the following Risk Factors:

Glucocorticoids--A report of exposure to oral glucocorticoids or exposure to oral glucocorticoids for over three months at a daily dose of 5mg or more is considered an indicator of risk. The presence of this factor is graded as a High Risk Indicator.

Parent Fractured Hip--The presence of a hip fracture--in the absence of significant trauma--in a parent is cause for increased risk. The presence of this factor is graded as a Moderate Risk Indicator.

Rheumatoid Arthritis--A report indicating the patient has a confirmed diagnosis of rheumatoid arthritis is considered an indicator of risk. The presence of this factor is graded as a Moderate Risk Indicator.

Secondary Osteoporosis--A report indicating the patient may have any of the following conditions (Insulin Dependant Diabetes, Osteogenesis Imperfecta in Adults, Long-Standing Untreated Hyperthyroidism, Hypogonadism, Premature Menopause (<45 years), Chronic Malnutrition, Malabsorption or Chronic Liver Disease) and is considered to have an indicator of risk. The presence of this factor is graded as a Moderate Risk Indicator.



Figure 2-13: Page 1 of the Ten Year Fracture Risk Report

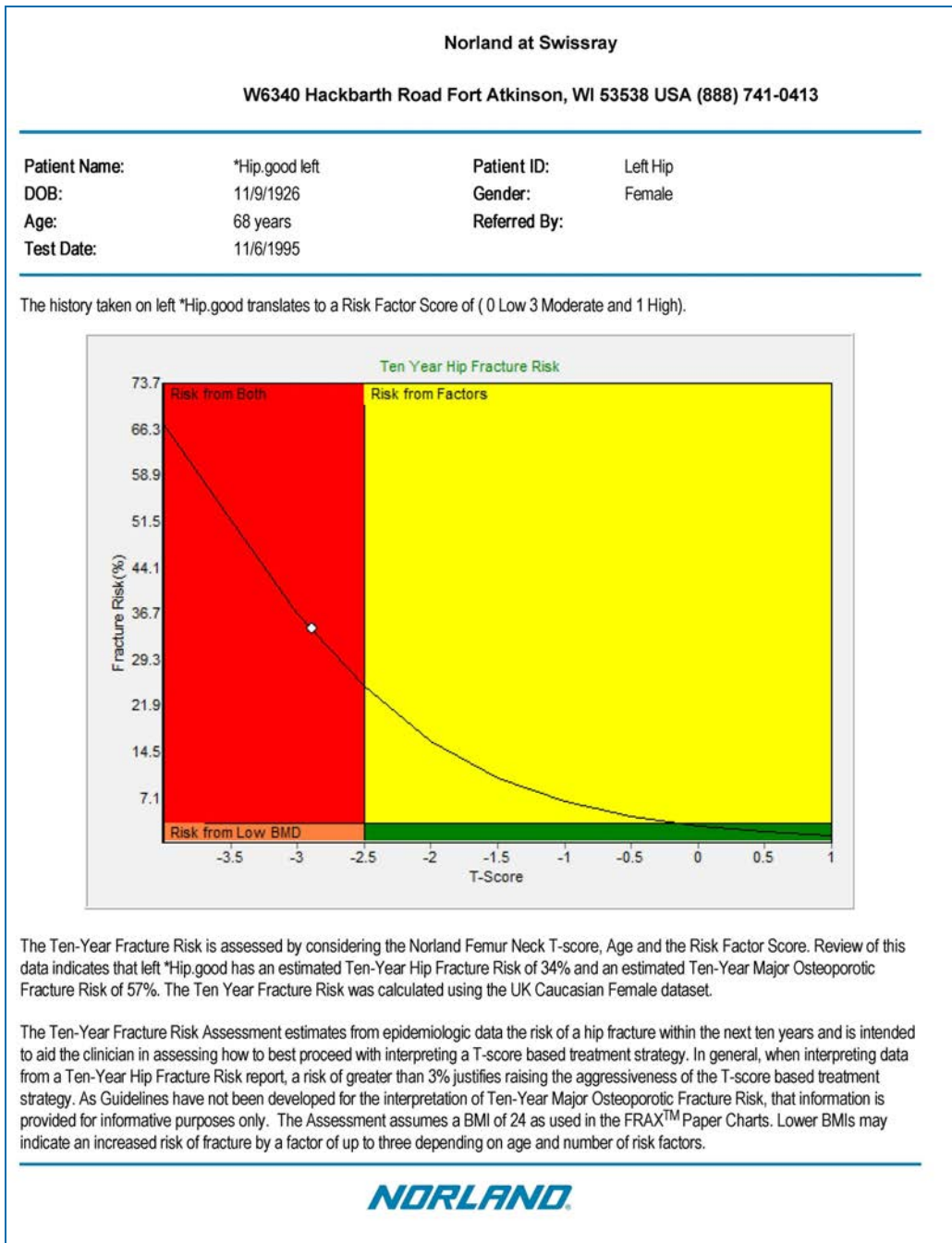

Figure 2-14: Page 2 of the Ten Year Fracture Risk Report

7: A Sample “Body Composition Report”

A **Body Composition Report** assesses the soft tissue and bone of a Whole Body scan to produce Body Fat Percentage results. This report can only be generated for Whole Body scans and is only available when the Body Composition Reports option is enabled.

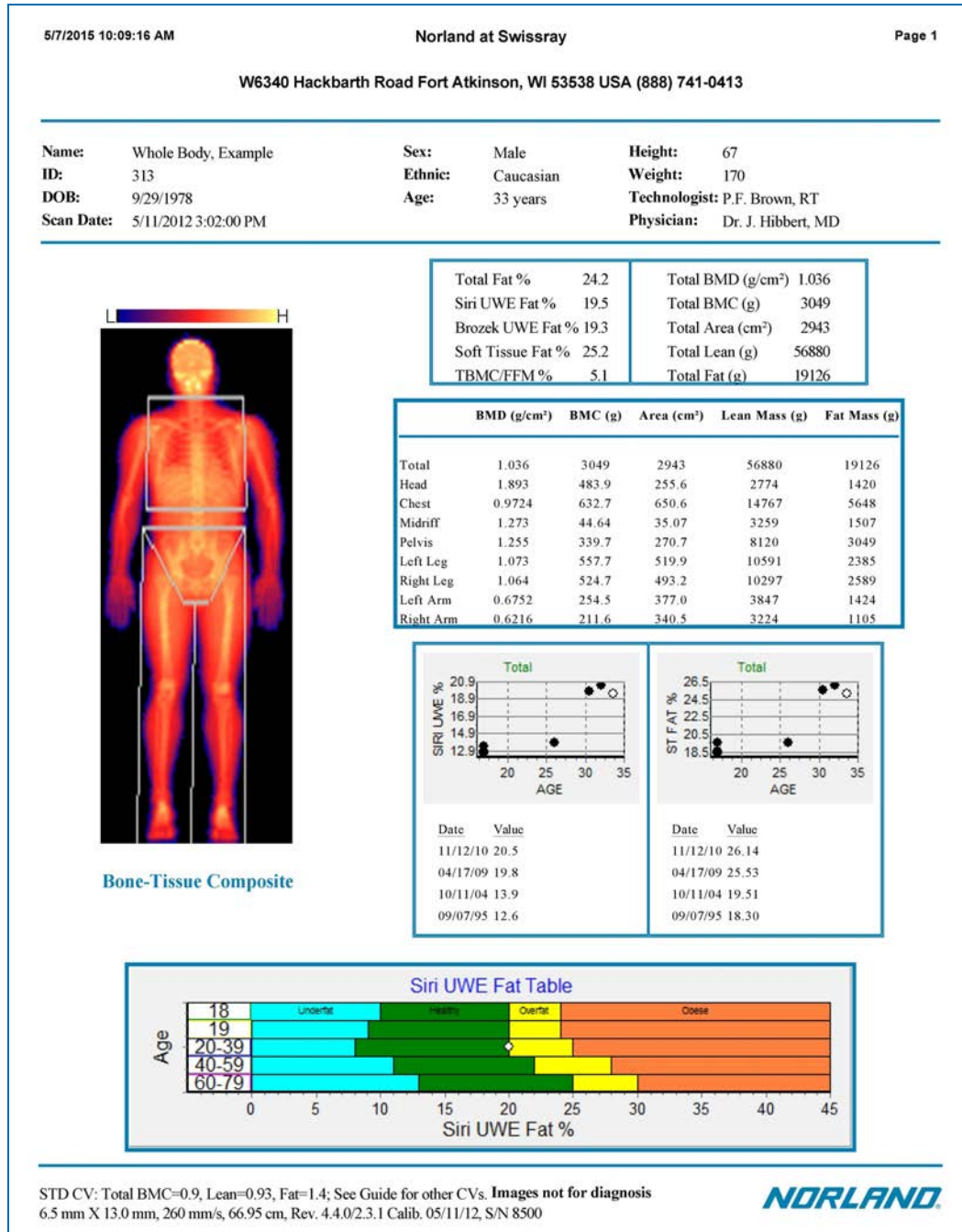

Figure 2-15: Page 1 of the Body Composition Report with trended results

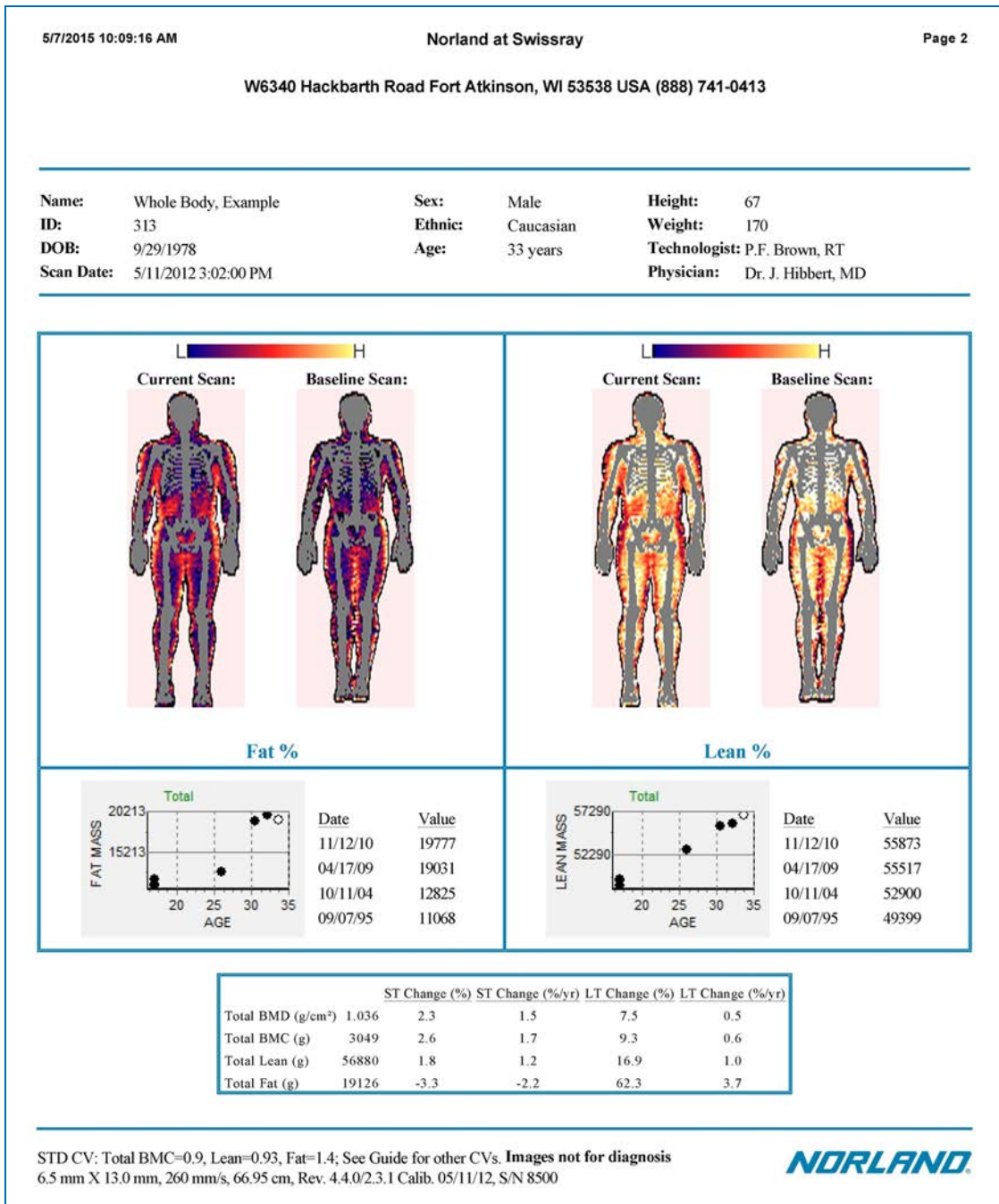

Figure 2-16: Page 2 of the Body Composition Report with trended results

Quality Assurance Reports

Following are sample Quality Assurance Reports.

As described later in this manual, daily system calibrations should be performed daily prior to patient scanning to ensure quality bone density estimates.

During the procedure, the QA Calibration Standard is measured first. Next, the QC Phantom is scanned. Your system will have either a clear or a black phantom, depending on its model or options.

Upon completion of this process, the operator is asked to print the results. These reports, labeled "**QC Results**" should be filed in a calibration log file as described in section "View and Print Calibration Results Reports" on page 4-14. Reports may also be saved electronically either in PDF or DiCOM format.

Please note that if the Clear Phantom is used, just one **QC Results** Report will be printed:

» BMD Precision

If the Black Phantom is used, three **QC Results** Reports will be printed

» BMD Precision

» Fat Precision

» Lean Precision

Sample Reports: Quality Assurance Report - BMD

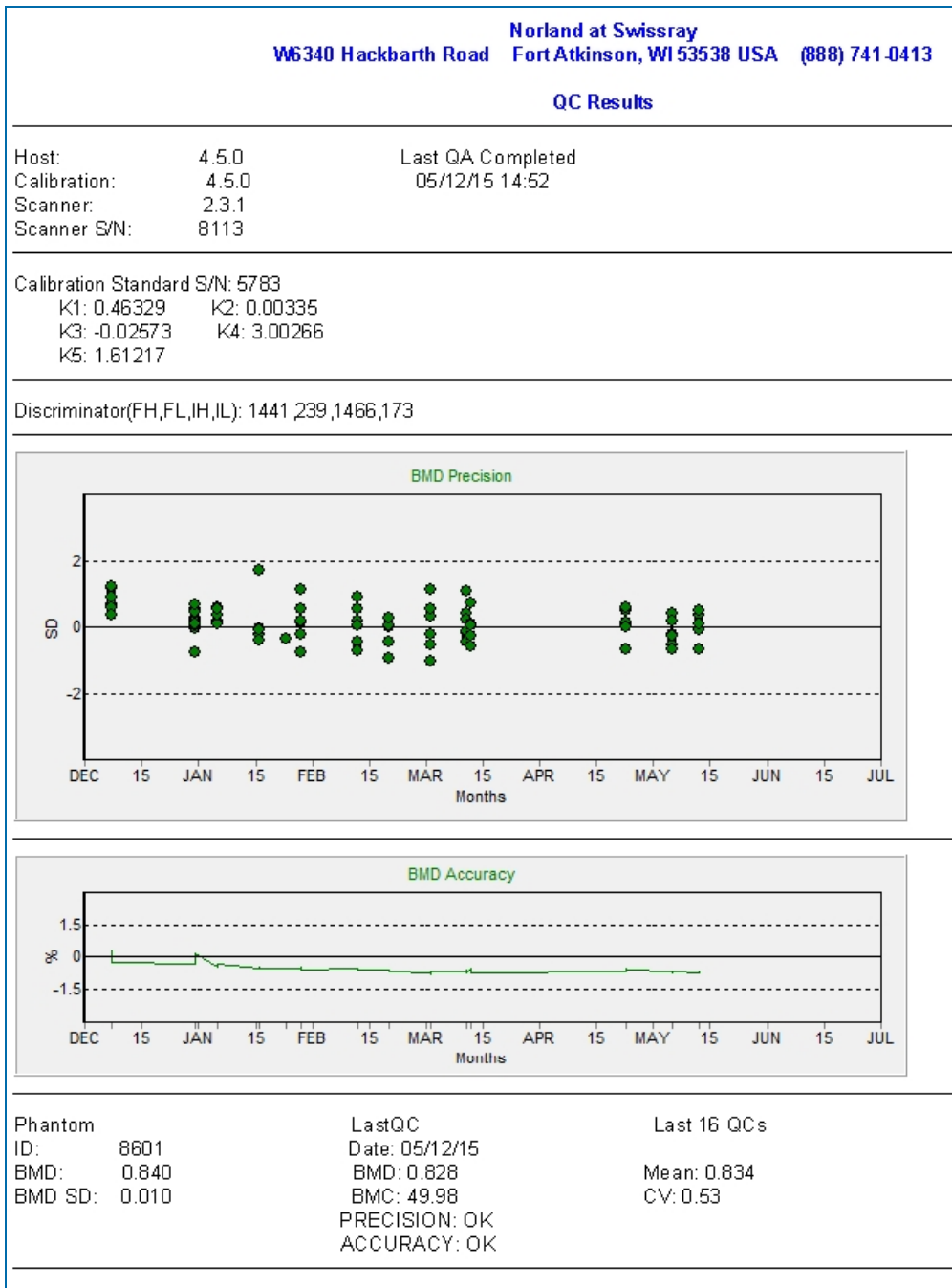

Figure 2-17: QC Results - BMD

Sample Reports: Quality Assurance Report - Fat

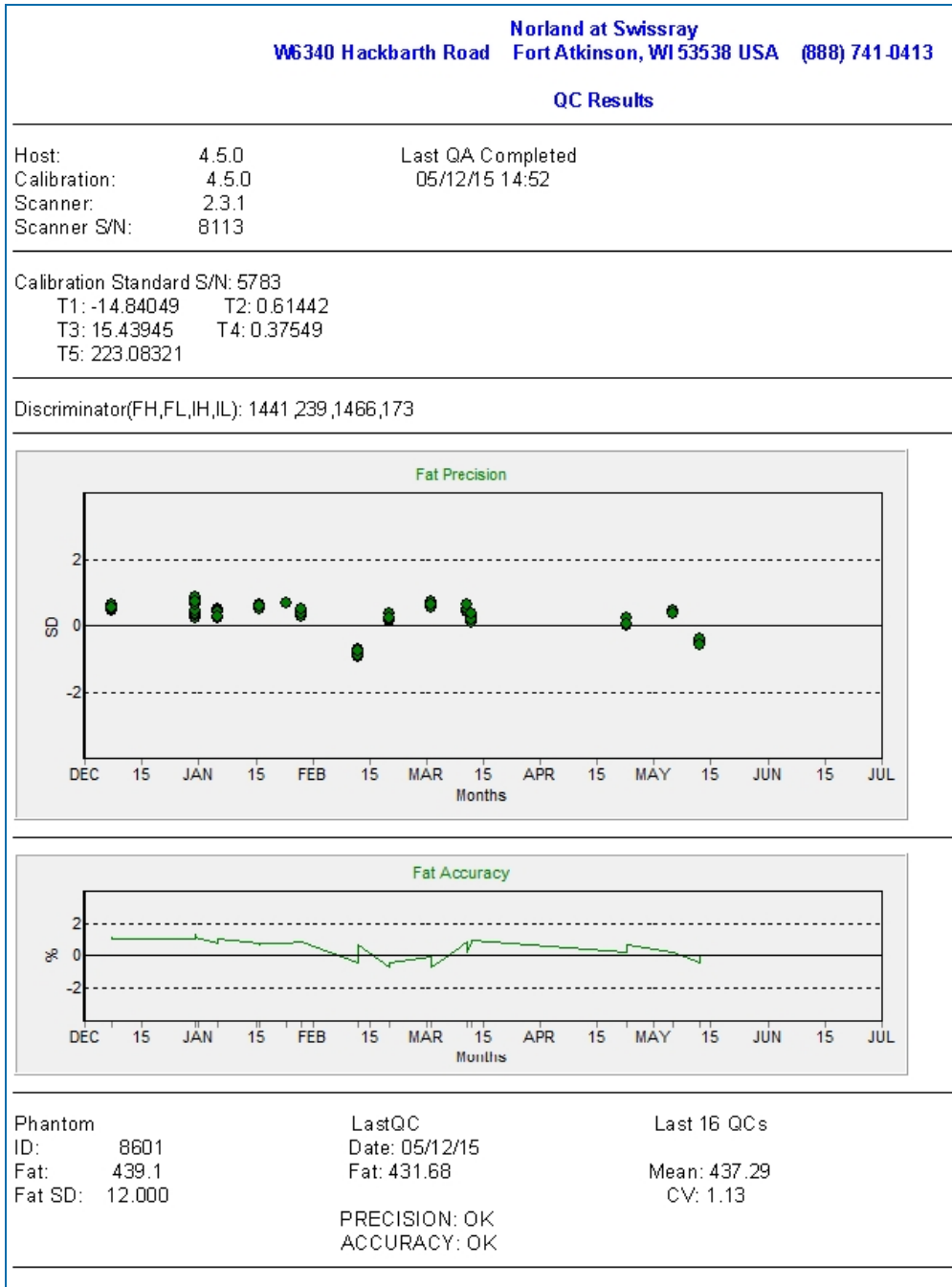

Figure 2-18: QC Results - Fat (an option)

Sample Reports: Quality Assurance Report - Lean

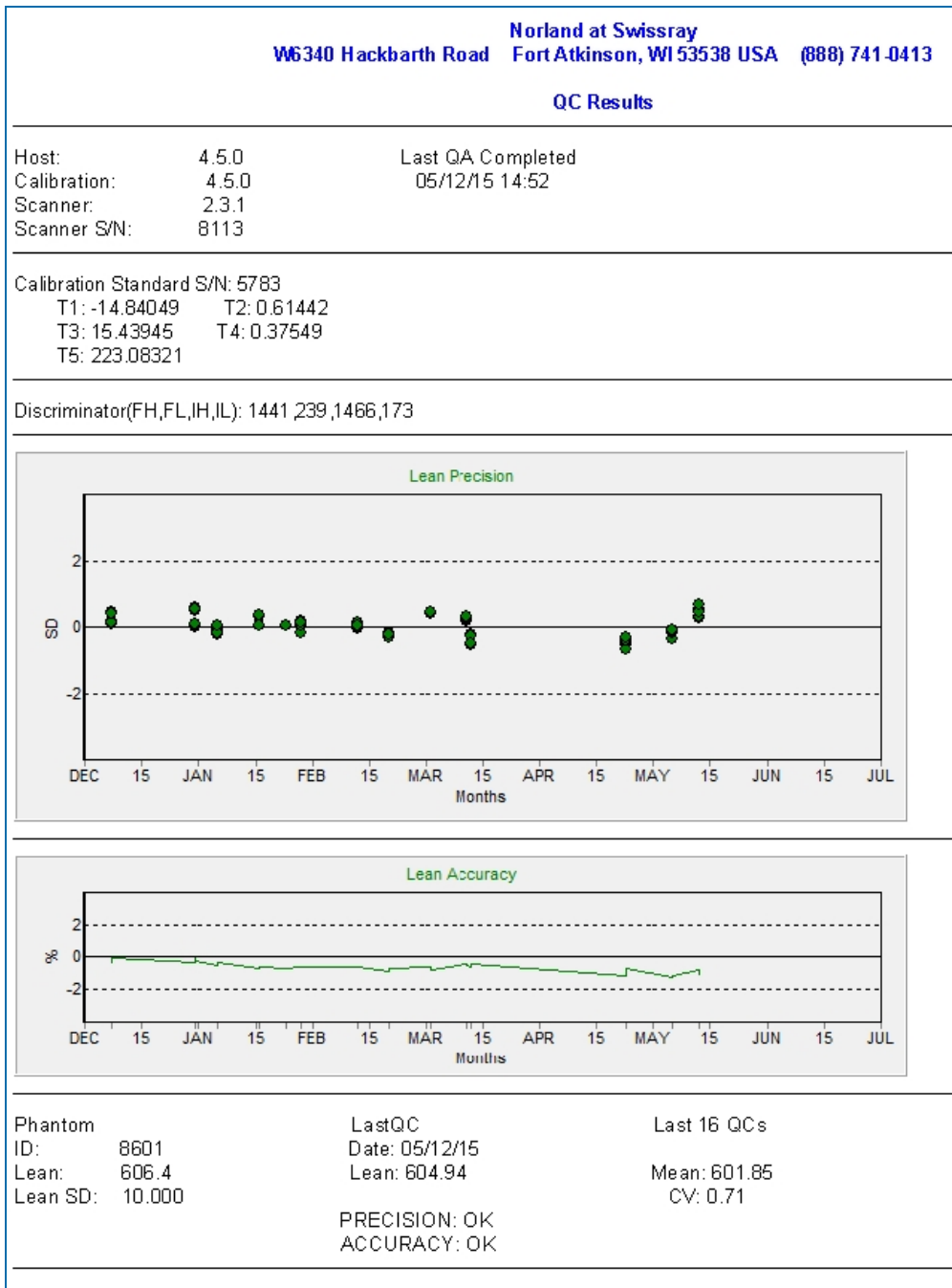

Figure 2-19: QC Results - Lean (an option)

This page intentionally left blank.

CHAPTER 3

Installation and Setup

The first part of this chapter includes the installation instructions for the Norland Illuminatus DXA software. The installation of the microphone and speakers is also discussed. Uninstalling the software concludes the installation section.

Instructions for logging on to the system follows next.

A thorough examination of the software completes this chapter. The five main menu commands: *File*, *Edit*, *Calibration*, *Tools*, and *Help* are discussed in detail. Numerous software screen shots are reproduced here for reference. Instructions for setting the scanner parameter default settings are also included.

This chapter discusses the following.

Software Installation Instructions	3-2
Uninstalling the Software	3-9
Logging into the Illuminatus DXA Software	3-12
Examining the Software	3-13
Database Navigator Window	3-14
Menu Commands Overview	3-16
File Command	3-17
Edit Command	3-18
Calibration Command	3-47
Tools Command	3-48
Help Command	3-52

Software Installation Instructions

Installing the IlluminatusDXA Software

This procedure assumes that the computer has been set up and is running. If you will be connecting to a network, you will need to know your SMTP domain name before beginning the installation. You can get it from your IT person.

1. It is recommended to **reboot** the computer prior to installing the software to ensure all programs have been properly closed.
2. Locate the IlluminatusDXA Software installation disk and insert it into the disk drive. A pop-up window appears:



3. Wait while the Wizard prepares the setup.

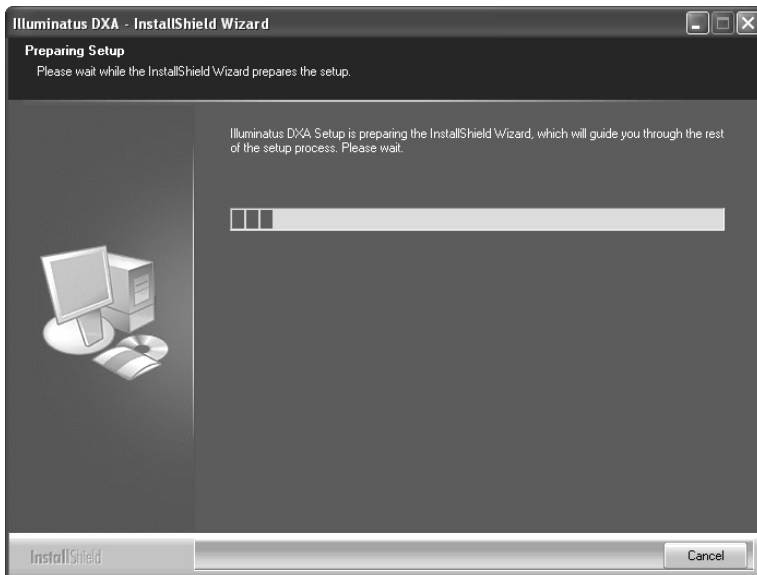

4. The Setup window opens. Click  when ready.

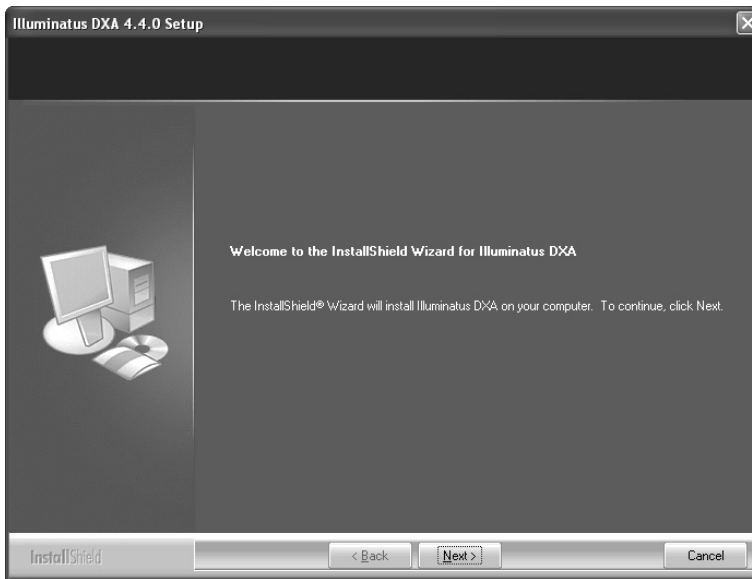

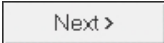
5. Norland recommends that you keep the *default* Destination Folder. (If you do not, certain files will not be created correctly and the software will not be able to find them.) Click .

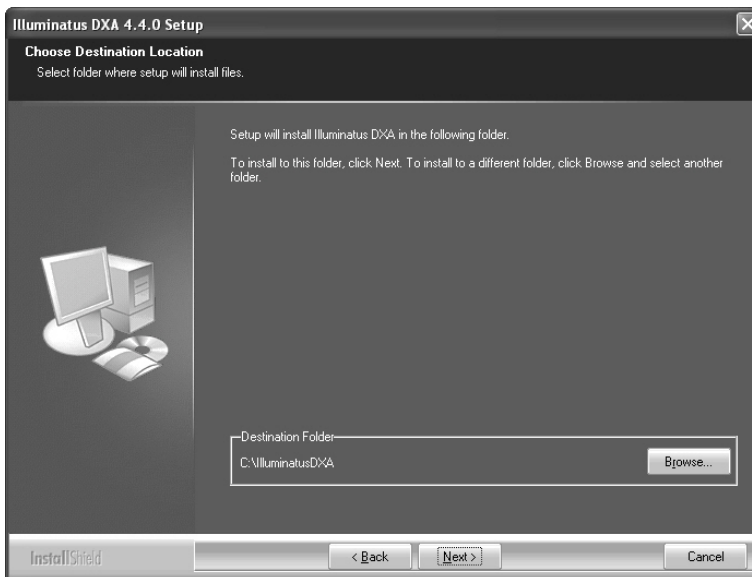

6. Select the language to be installed. (Note: To change the language selection, the program must be reinstalled.)

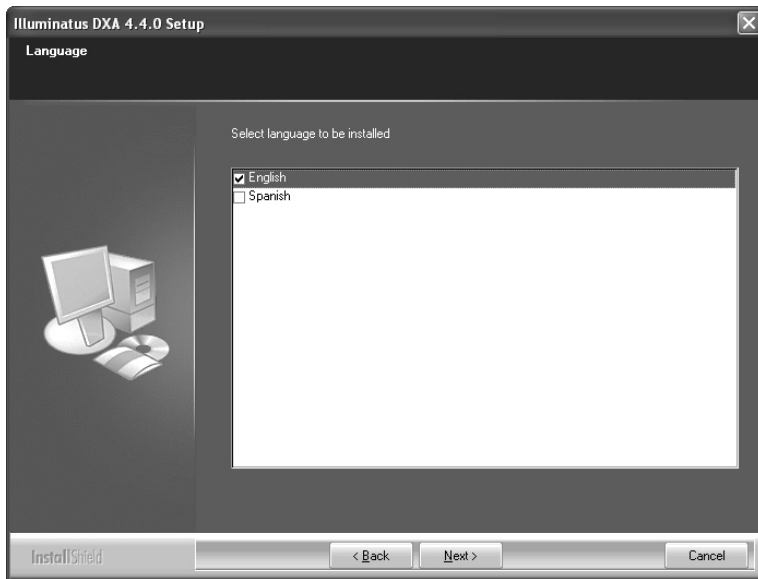

7. Wait while the software installs. . .

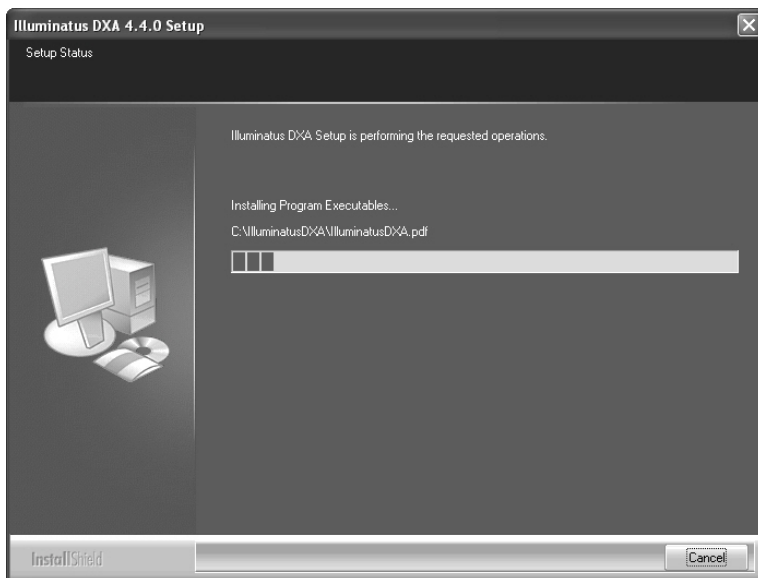

8. When the dialog box below appears, enter a descriptive name for the computer in the “**Name:**” box. Tab down to the next box and enter the pertinent information in the “**SMTP**” box. An example is “**mail.earth-link.net**”. If this information is unavailable, it may be entered later. Refer to “Network Tab” on page 3-43.

Click  when done.

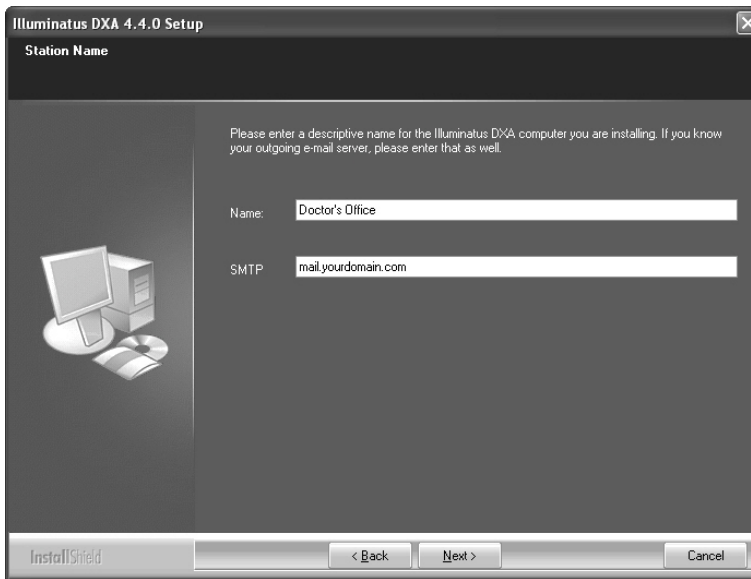

9. Wait while the changes are being written to disk and the drivers are installed. Click OK at the confirmation message.

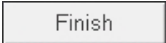

10. Adobe Acrobat Reader will be installed. Follow all prompts to complete the installation.
11. When the following window appears, confirm that the **“Yes”** radio button is selected and click . The window will close, and the computer will restart.

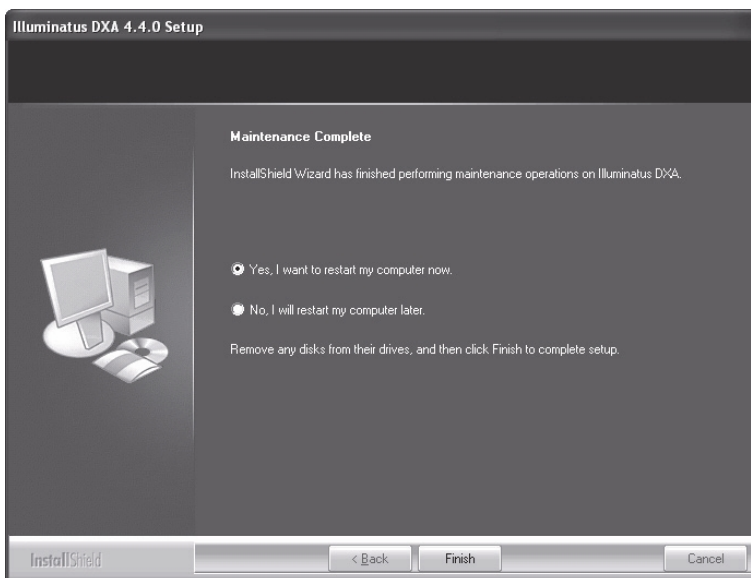

12. Wait for the computer to log off and re-boot.
13. Log in to your account.
14. Wait until the computer is completely done logging in.
15. Plug in the Aladdin USB HASP key (that came with the software) into a USB port.
16. The computer will notify you that it detects new hardware and proceeds to install the drivers.
17. Wait for the driver installation to complete.
18. Installation of the software is now complete.
19. Remove the installation CD and store in a safe place.

The next few pages discuss some other set up instructions that should be completed before you actually log into the Bone Density software:

- » "Configuring Backup for Windows 7" on the facing page or "Configuring Backup for Windows 10" below to configure the Windows Backup if the computer was not provided by Norland.
- » "Installing the Microphone" on the facing page

See "Logging into the Illuminatus DXA Software" on page 3-12 when ready.

Configuring Backup for Windows 10

Computers provided by Norland with Windows 10 include the EaseUS Todo Backup program to automatically perform a backup of the IlluminatusDXA software and data on a daily schedule. To configure the EaseUS backup program on a computer not provided by Norland, follow the steps below. (The EaseUS program may be used on any system running Windows XP or newer.)

1. Obtain the latest version of the EaseUS Todo Backup program from the vendor. Install the program with default settings.
2. Insert a flash drive to be used for backup into an available USB port.
3. To allow the backup program to utilize the full capacity of the USB drive, drives should be formatted with an NTFS filesystem.
4. Open the EaseUS Todo Backup program.
5. Select "File Backup".
6. Deselect all default folders from the tree.
7. Under the Computer branch, check the box next to C:\IlluminatusDXA.
8. For the Destination Folder, browse to your USB flash drive.
9. Change the Plan Name to Norland Backup.



Note: Backup encryption is highly recommended when using removable backup drives. The EaseUS backup program may be configured to use password-based encryption. If the option is used, store your encryption password in a safe place. An encrypted backup cannot be restored without the password.

10. Click the Schedule button and change the settings to:
 - » Schedule Type: Daily
 - » Time: 7:00pm
 - » Backup Method: Full Backup
 - » Click Save
11. Save the backup job settings.

12. For the Norland Backup job, click Backup, and select Full Backup to run the backup.
13. Allow the backup to complete. When finished, close the backup program.

Configuring Backup for Windows 7

Computers provided by Norland with Windows 7 are configured to automatically perform a backup of the IlluminatusDXA software and data on a weekly schedule. To configure the backup on a Windows 7 computer not provided by Norland, follow the steps below.

1. Insert a flash drive to be used for backup into an available USB port.
2. To allow the backup program to utilize the full capacity of the USB drive, drives should be formatted with an NTFS filesystem.
3. Click the Start menu, All Programs, Maintenance, and select Backup and Restore.
4. Click "Set up backup".
5. Select the flash drive ("Removable Disk") to be used for backup. Click Next.
6. When prompted for what to backup, select "Let me choose..." and click Next.
7. Click the arrow next to Local Disk (C:) to expand the tree.
8. Check the box for the IlluminatusDXA folder to select all contents. Click Next.
9. Click "Change schedule".
10. Check the box for "Run backup on a schedule".
11. Change the schedule settings to:
 - » How often: Weekly
 - » What day: Monday
 - » What time: 7:00 pm
12. Click OK.
13. Click "Save settings and run backup".
14. Allow the backup to complete. When finished, close the Backup and Restore window.

Installing the Microphone

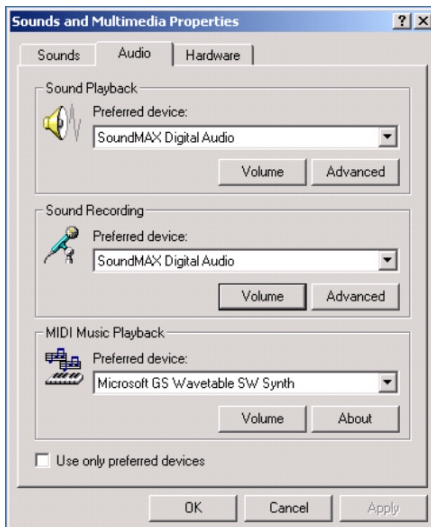

Follow these instructions to install the microphone and speakers (if not already done).

1. Plug the microphone connector into the mic jack on the computer.
2. Click **Start > Control Panel**.
3. Click on **Sounds and Audio Devices**.
4. Click the Audio tab. Then click the Sound Recording  button.

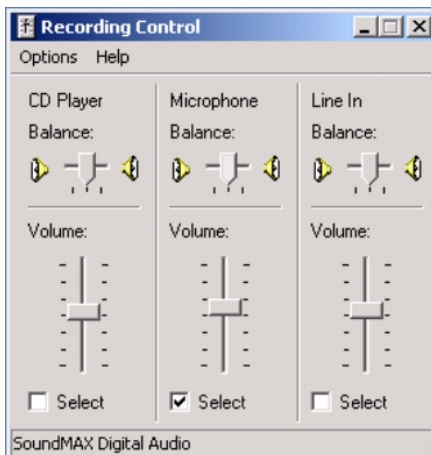

- Click the Microphone **“Select”** check-box then adjust the slide bar to the middle setting.



- Click the  to close the dialog box.
- Click  to apply the changes and close the window.
- Close the Control Panel dialog box (click  or **File > Close**).

Uninstalling the Software

Follow these instructions to uninstall the Illuminatus DXA software, if necessary.

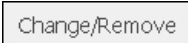
1. Reboot the computer to confirm all programs have been closed.
2. Remove the HASP USB key.
3. Click **Start > Control Panel**.
4. Double-click on **Add or Remove Programs**.
5. Scroll down to select *Illuminatus DXA* and click . The following window opens.

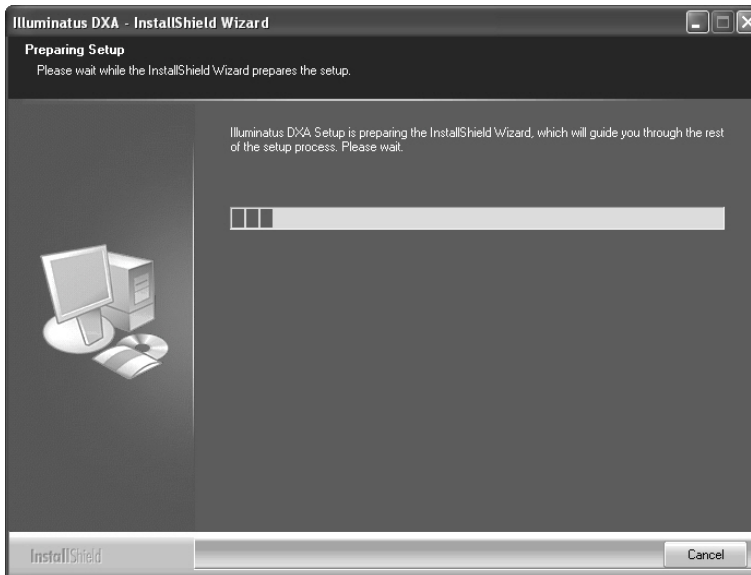

6. Click to select **Remove** and click .

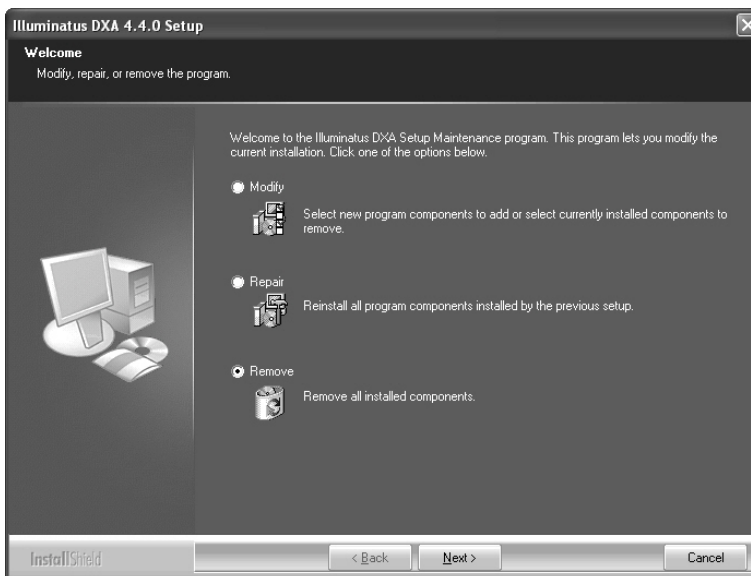

7. In the “**Confirm Uninstall**” dialog box, click .

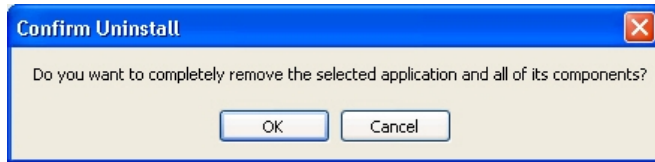

8. When the following window opens, decide if you want to completely remove your patient Databases (click), or leave them installed (click .

 **Caution:** Selecting **Yes** will permanently delete all of your patient data and scanner setup files.

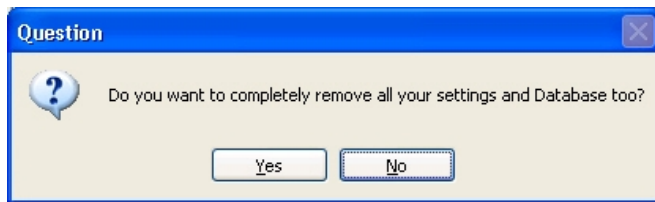

9. Wait while the software continues to uninstall the Norland software.

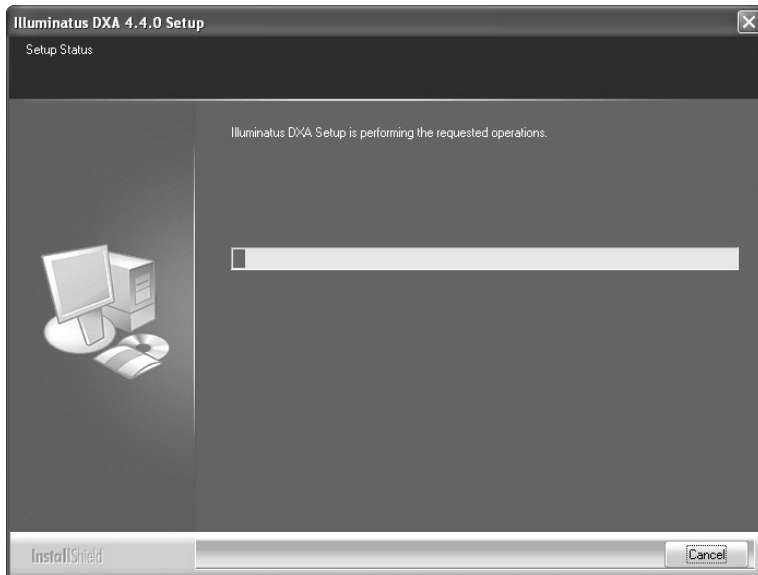

10. Upon completion, the following window opens. Select Yes to restart the computer now or select No to restart later.

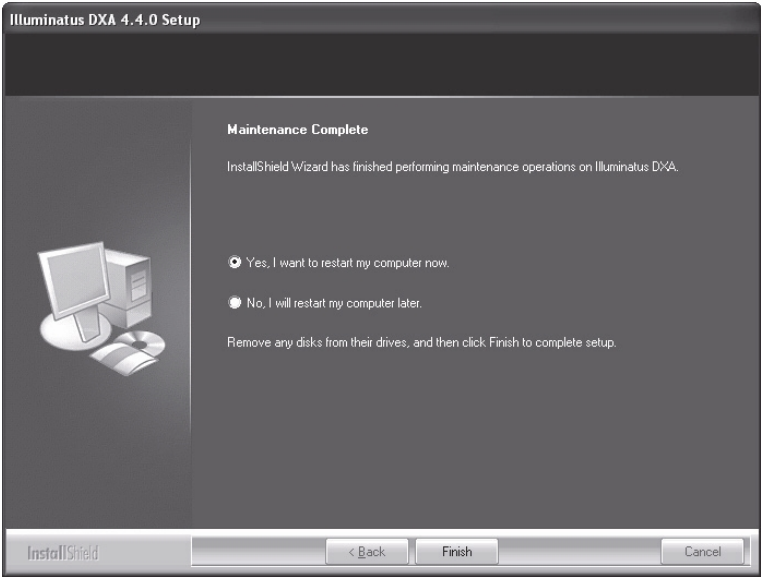

11. Click Finish.

Logging into the Illuminatus DXA Software

Notice the three new icons on the desktop: **Illuminatus DXA**, **DXA Backup** and **DXA Utilities**. Now that the Norland Illuminatus DXA Bone Densitometer software is installed, open it up!

1. Confirm that the HASP key is plugged into the USB port.
2. Double-click the icon on the desktop  labeled Illuminatus DXA to start the software.
OR. . . click on **Start > Programs > Norland > Illuminatus DXA**.
3. **First time login:** The following window pops up (after the initial splash screen) when logging in for the first time. Click .



4. At the Login window, enter the user's Login name (click the drop-down arrow, if necessary) and then type the Password. The default password is **norland**.

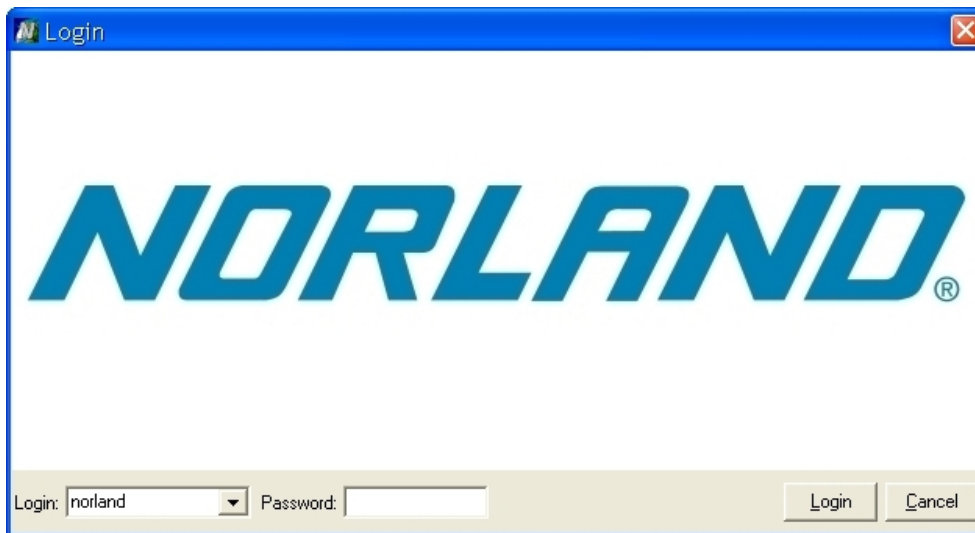

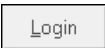
5. Click  and wait while the software initializes the Scanner.

Examining the Software

Norland Bone Densitometry devices are controlled by menu driven software that follows a Windows based design. The main software window is called the **Database Navigator** window. All Norland program actions are initiated by moving a mouse pointer to the menu bar located along the top of the window or the navigation buttons along the bottom of the window.

Hot keys are also available by pressing the <Alt> key and then the underlined letter, i.e. <F> for "File".

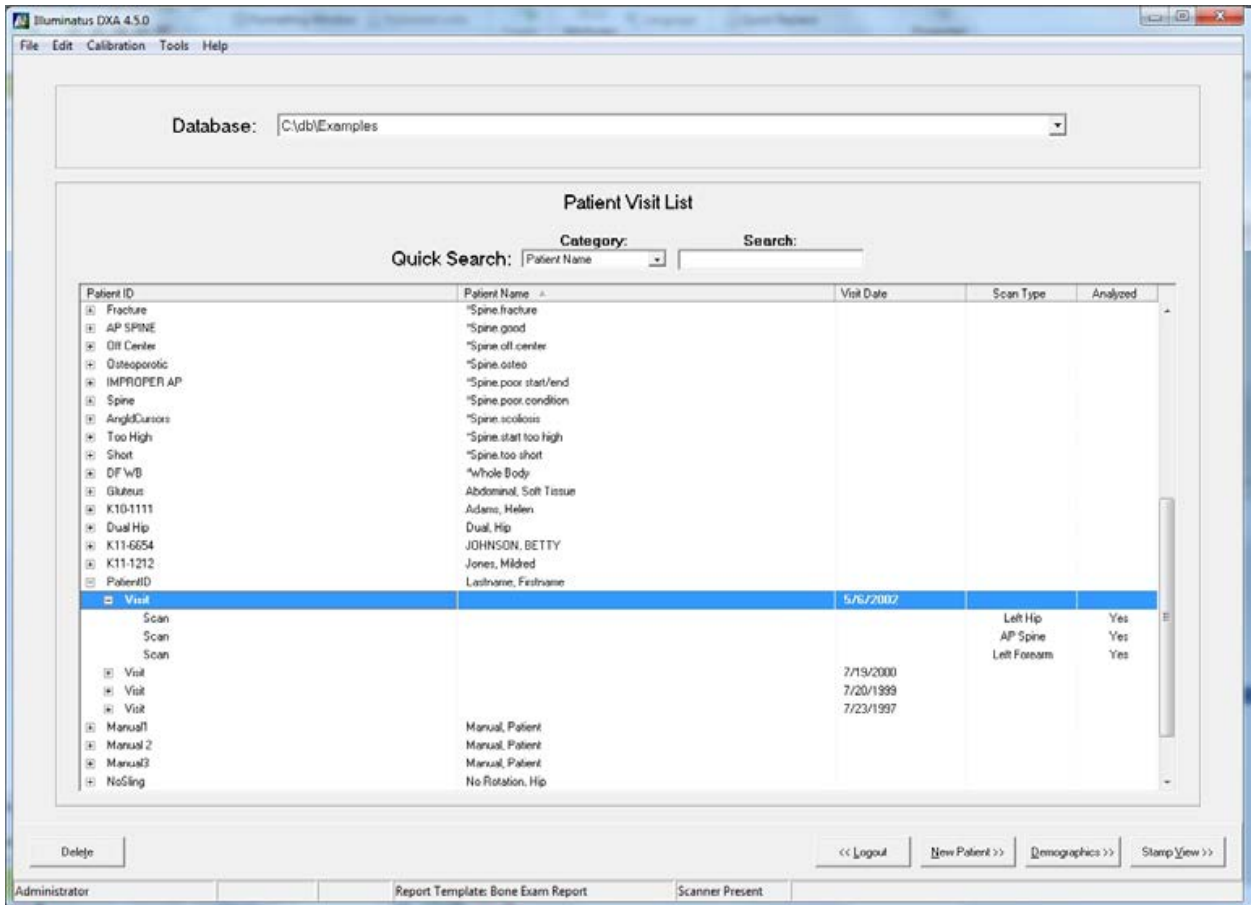
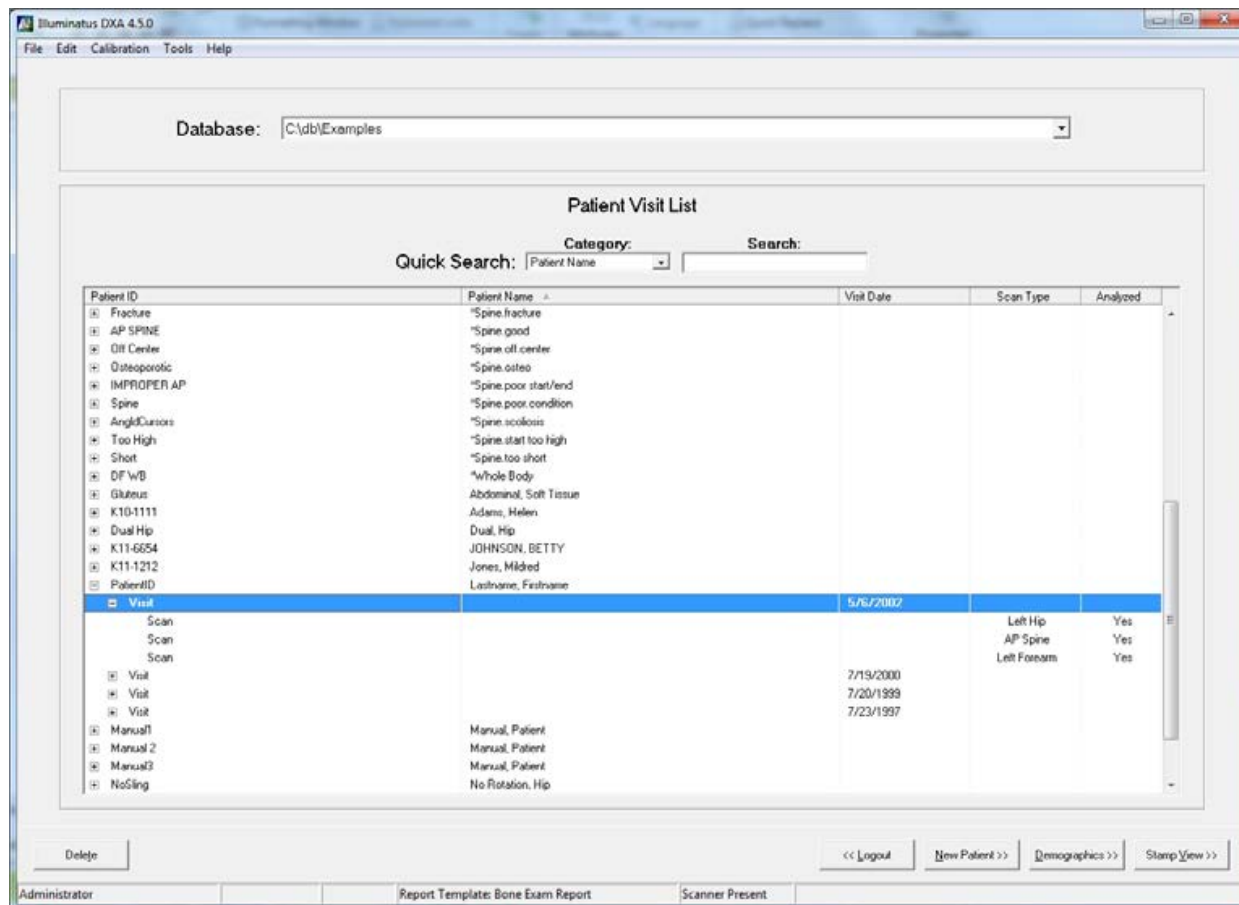

Figure 3-1: Example Database Navigator Window

Database Navigator Window

The Norland Bone Densitometer main window is referred to as the **Database Navigator** window in this manual. It is shown below.

All the visits pertaining to one patient are grouped together and sorted under that patient's name and ID number. This is described in detail in this section.



<< Log Out

Logs out the current user account in the host software and goes to the login window.

New Patient >>

Displays a blank **Patient Demographics** window. It is used for inputting information on a new patient.

Demographics >>

Displays the current patient demographics window of the currently selected patient.

Stamp View >>

Displays the "Stamp View" of all the scans available for the currently selected visit. The **Stamp View** button will be grayed out (not click-able) if a scan is not available for that patient.

Delete

Deletes the entire Patient *file* that is highlighted, or the *visit* that is highlighted. Follow the instructions in the window that pops up.

Database Navigator Window Description

The menu bar is located along the top of the window. Click on a menu name to reveal a drop-down list of command names. The commands are: *File, Edit, Calibration, Tools, and Help.*

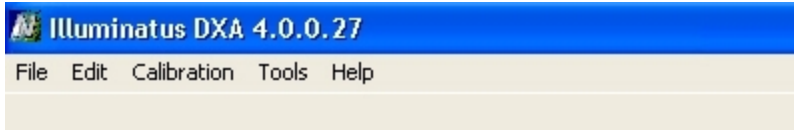

These commands perform functions in the system software. They are described in detail in this chapter.

The Database field has a drop-down arrow that lets the operator select from different database files.





The Quick Search feature of the window has two categories: **Quick Search by Patient ID** and **Quick Search by Patient Name** (viewed in the Category drop-down list).

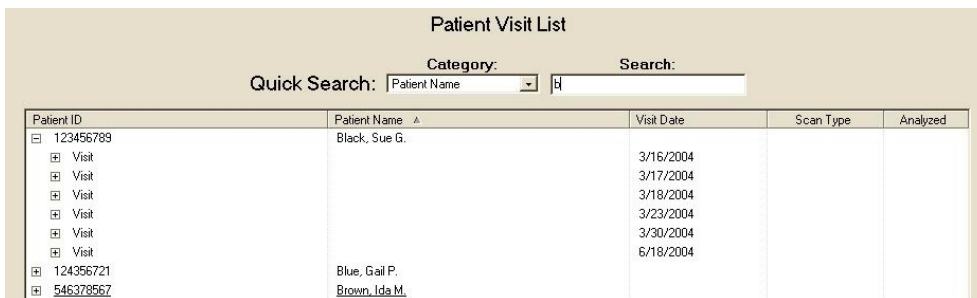

The operator simply selects the search Category (ID or Name) and types the first few characters. The search is interactive, and will return all values beginning with the characters you are typing as each key is pressed.

The Patient Visit List Tree: As mentioned earlier, the Patient Database now has all the visits pertaining to one patient grouped together and sorted under that patient's name and ID number.



Click on the expand () button next to a patient ID number and the database will branch out into visits. Click the plus sign next to a visit, and it branches out into the scans done during that visit.

Menu Commands Overview

As mentioned earlier, when you click any one of the menu names along the top of the Database Navigator window, a list of commands “drop” down.

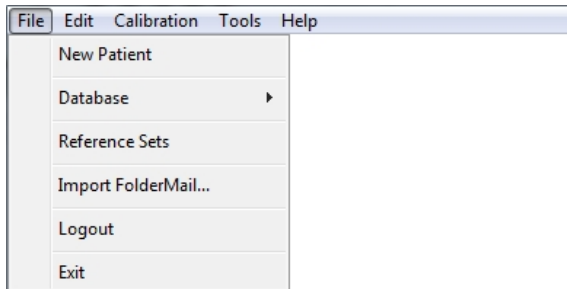

Some commands are grayed out due to one of the following reasons:

- » The option is not valid for the current operation.
- » The option is already in effect.

The five different Menu commands are described in detail next: *File*, *Edit*, *Calibration*, *Tools*, and *Help*.

File Command

To view the File commands, click on *File* in the Database Navigator window. Move the pointer down to highlight the command of interest and click on it. The highlighted command will execute.

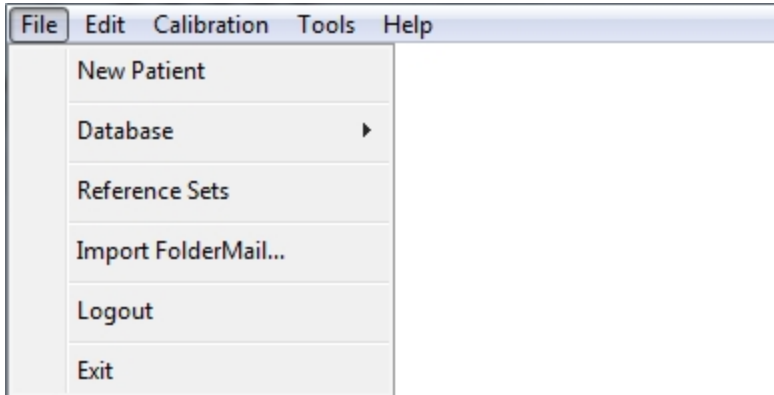

Quick Descriptions: File drop-down list

New Patient: displays the Patient Demographics window for inputting patient information. The steps for creating a New Patient record are in **Chapter 4, Basic Operation**, under "Creating a New Record for a New Patient" on page 4-21.

Database: provides access to all the database functions, including Add to List and Remove from List of an Active Database, as well as Create, Import, and Export. These selections are discussed in **Chapter 11, Additional Techniques**, under "Database Management" on page 11-14.

Reference Sets: displays the Reference Set window. Right click on any entry in that window to Edit or Delete a reference. Reference Set details are explained in **Chapter 11, Additional Techniques**, under "Working with Reference Sets" on page 11-26.

Import FolderMail: opens a browser dialog box to import a patient's folder that was received via e-mail (you must have a FolderMail e-mail attachment file to be imported). The extension is .IQF. The steps for Import FolderMail are in **Chapter 11, Additional Techniques**, under "How to Import FolderMAIL to a Database" on page 11-13.

Logout: Terminates the current session, and returns the user to the login window.

Exit: Closes all open dialog boxes, closes any open databases, and finally terminates the application.

Edit Command

To view the Edit commands, click on the Edit menu in the Database Navigator window.

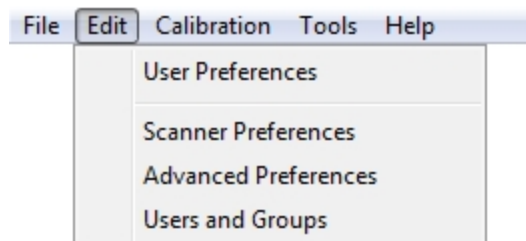

Quick Descriptions: Edit drop-down list

User Preferences

Main Settings tab: displays dialog box for changing login name and password, e-mail address, and the width and height of the Stamp View thumbnail. See details in "User Preferences Command" on page 3-20.

Scanner Preferences

Displays four different tabbed dialog boxes for setting *Site* information, *Scanning* parameters, *Analysis* parameters, and *Service* Information (for calibration setup). See details on "Scanner Preferences Command" on page 3-21.

The Site tab includes fields for the facility name and address and the scanner identification information. The available options are displayed once the Options Authorization Code (OAC) is entered. See "Site Tab Setup" on page 3-22.

The Scanning tab includes an area for each scan type. Each scan type has its own parameters that can be edited by the operator. The "Restore Factory Defaults" button restore the original factory settings. See "Scanning Tab Setup" on page 3-23.

The Analysis tab includes an area for each scan type. Each scan type has its own parameters that can be edited by the operator. The "Restore Factory Defaults" button restore the original factory settings. See "Analysis Tab Setup" on page 3-31.

The Service tab displays the Scanner, Calibration Standard and QC Phantom serial numbers. It also describes various values for the Calibration Standard and QC Phantom. See "Service Tab Setup" on page 3-39.

Advanced Preferences

Displays a few different tabbed dialog boxes. The tabs of interest are described next. See "Advanced Preferences Command" on page 3-40 for all the details.

Customer Info tab: this is where you enter the Business name and address information.

Printing tab: allows the operator to set the print margins when printing Reports.

Directories tab: this is where the various paths are set.

Network tab: allows the administrator to enter E-mail information, the machine location and SMTP Server host name (as well as other things).

Users and Groups

The User Editor dialog box contains two tabs - a Users tab and a Groups tab. See "Users and Groups Command" on page 3-45.

Users > Main Settings: displays the dialog box for changing login name and password, e-mail address, and the width and height of the Stamp View thumbnail.

Users > User's Groups: contains the Group List.

Users > Additional Settings: has Security Privileges settings.

Groups tab: contains the Group List.

User Preferences Command

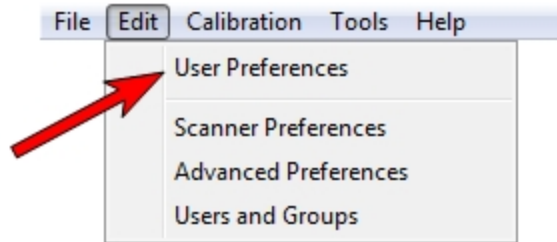

Clicking on the User Preferences selection displays tabbed windows that lets the current user change their login and e-mail information. The width and height of the Stamp View thumbnail (that is displayed in the Stamp View window) can be set here, also.

Click on **Edit > User Preferences** to open the following windows:

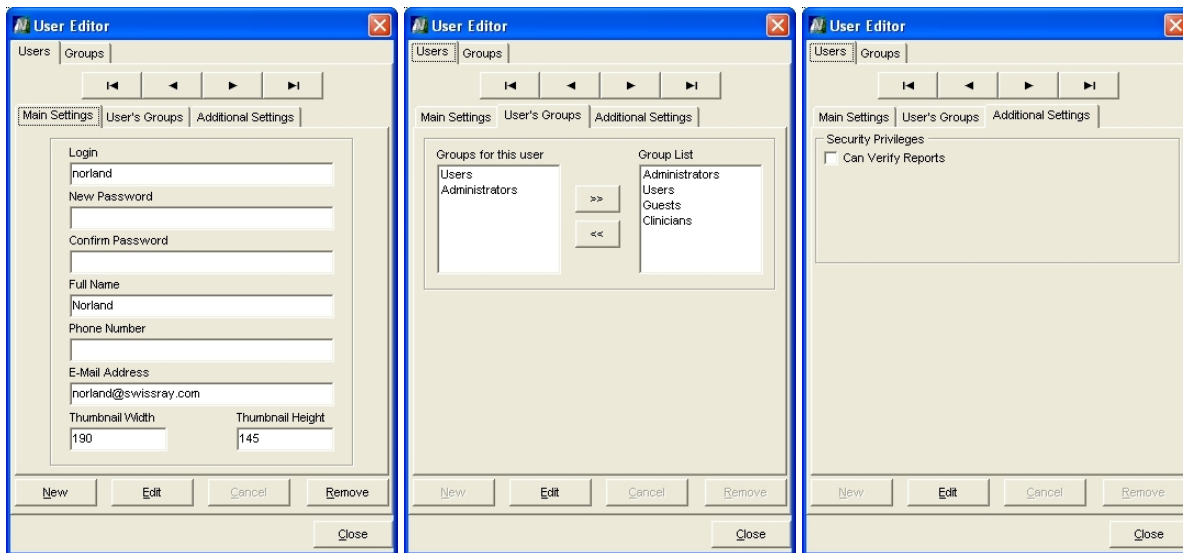

Note: An e-mail address must be entered in the "E-Mail Address" box to enable the FolderMAIL option.

Scanner Preferences Command

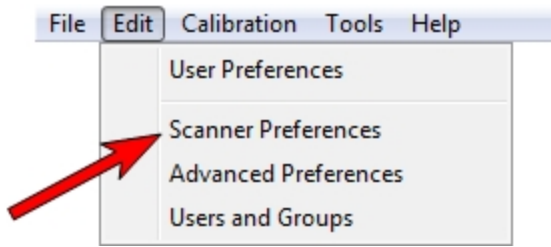

The Scanner Preferences selection displays four different tabbed dialog boxes for setting *Site* information, *Scanning* parameters, *Analysis* parameters, and *Service* Information.

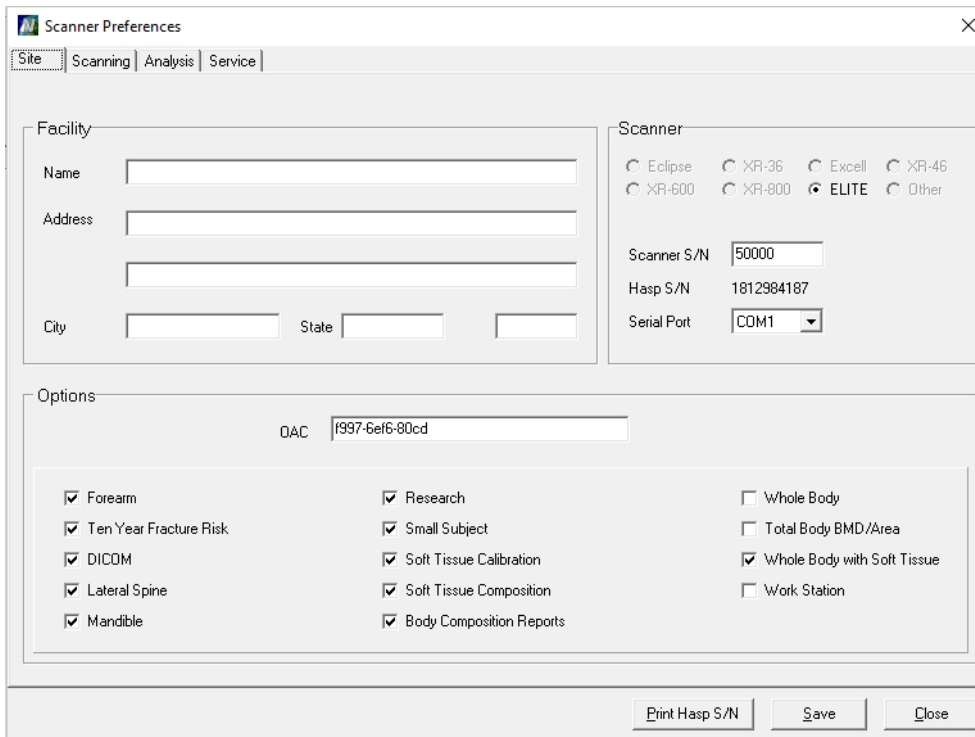

Figure 3-2: The Scanner Preferences selection window

Most of the scanner parameters will be set during installation prior to applications training. Settings will be discussed with the operator during the training to ensure a complete understanding. The scanner preferences can be customized to suit each facility's needs. However, when the needs of the facility change, the system can easily be reconfigured.

The changed parameters become the default condition for subsequent procedures when they are set from the Scanner Preferences window. They remain the default settings until changed by the operator.

Site Tab Setup

The Site tab is accessed by clicking on **Edit > Scanner Preferences**. Then click the Site tab.

The Site tab allows the operator to enter the site and scanner identification information. The available software options are displayed once the Options Authorization Code (OAC) is entered by the installer.

- » Enter the Scanner Serial Number.
- » To use a serial port other than COM1, make the appropriate selection.
- » If you have been provided with an OAC code for your scanner, enter it in the OAC box.
- » Click  to store the scanner settings and OAC.

Scanner Preferences

Site | Scanning | Analysis | Service

Facility

Name:

Address:

City: State:

Scanner

Eclipse
 XR-36
 Excell
 XR-46
 XR-600
 XR-800
 ELITE
 Other

Scanner S/N:

Hasp S/N:

Serial Port:

Options

OAC:

Forearm
 Research
 Whole Body
 Ten Year Fracture Risk
 Small Subject
 Total Body BMD/Area
 DICOM
 Soft Tissue Calibration
 Whole Body with Soft Tissue
 Lateral Spine
 Soft Tissue Composition
 Work Station
 Mandible
 Body Composition Reports

Print Hasp S/N Save Close

Figure 3-3: The Site tab preferences window

Scanning Tab Setup

The Scanning tab is accessed by clicking on **Edit > Scanner Preferences**. Then, click the Scanning tab.

Here, the operator can set several scan preferences. The scanning preferences available include: AP Spine, Hip, Forearm, Whole Body, Lateral Spine, and Research/Small Subject.¹ They are described in the next few sections.

The default parameters for all the scanning operations are set and reset here. These setup options are typically reviewed and modified during system installation or during training. The different parameters are described in the next few sections.

The screenshot shows the 'Scanner Preferences' dialog box with the 'Scanning' tab selected. The dialog is divided into several sections for different scan types:

- AP Spine:** Resolution (mm) with radio buttons for 1.0x1.0 and 1.5x1.5 (1.5x1.5 is selected); Scan Width (cm) set to 12.0; checkboxes for Auto Center (checked) and Force mark points on-axis (unchecked); Scan Speed dropdown set to Standard (130 mm/sec).
- Hip:** Resolution (mm) table with Scout (1.0x4.0) and Measure (1.0x1.0); Scan Width (cm) table with Scout (12) and Measure (9); Scan Length (cm) table with Scout (12) and Measure (9); radio buttons for Standard Width (selected) and Extended Width (unselected); Scan Speed dropdown set to Standard (90 mm/sec).
- Forearm:** Resolution (mm) table with Scout (1.0x1.0) and Measure (1.0x1.0); Scan Width (cm) table with Scout (8) and Measure (8); Scan Length (cm) table with Scout (Up to Proximal) and Measure (1.0); radio buttons for Distal (unselected), Proximal (unselected), and Both (selected); Scan Speed dropdown set to High Speed (20 mm/sec).
- Whole Body:** Resolution/Speed dropdown set to 6.5x13.0mm 260mm/sec.
- Lateral Spine:** Resolution (mm) table with Scout (1.5x3.0) and Measure (1.0x1.0); Scan Width (cm) table with Scout (14.25) and Measure (10); checkbox for Snap measure scan on-axis (unchecked); Scan Speed dropdown set to Standard (30 mm/sec).
- Research/Small Subject:** Resolution (mm) table with Scout (3.0x3.0) and Measure (1.0x1.0); Scan Speed (mm/sec) table with Scout (60) and Measure (60); Scan Width (cm) table with Scout (13.8) and Measure (10.0); checkboxes for Scout Scan (checked) and Force initial scan on-axis (checked); Maximum degrees to snap final scan on-axis set to 15; Research Scan Type Name set to Research; Sm Subject Scan Type Name set to Sm Subject.

At the bottom of the dialog, there is a 'Restore Factory Defaults' button, and 'Save' and 'Close' buttons.

Figure 3-4: The Scanning tab preferences window

Disable Patient Positioning Instructions

When checked, this option will disable the instructions for patient positioning that appear prior to scanning the patient. However, this is not recommended unless the operator is well versed in patient positioning.

¹Forearm, Whole Body, Lateral Spine, and Research/Small Subject are not available on some models.

Preferences: AP Spine Scan

The following figure shows the default AP Spine Scan parameters. The default settings should be effective for most scanning situations.

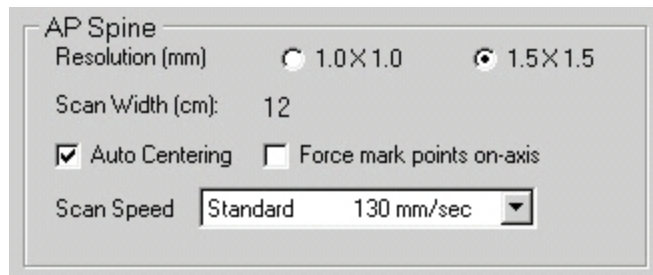

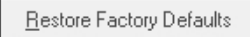
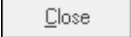



Figure 3-5: The default AP Spine Scan Parameters

 **Note:** WHAT TO DO: To restore the *default* Scan parameters, click  and . This will restore the defaults for *all* scan types.

 **Note:** WHAT TO DO: To *change* the default Scan parameters, access the Scanner Preferences window from the main Database Navigator window as described next.

If it is not already open, click on **Edit > Scanner Preferences > Scanning** tab.

Locate the AP Spine scan parameters in the window (shown above).

Select and change any of the scan parameters, such as resolution, scan width, or speed.

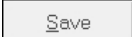
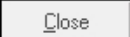
Click  and  at the bottom of the window. These settings now become the default settings until changed again.

PARAMETER DESCRIPTIONS:

- » **Scan Resolution:** the (data point size) x (scan line size) in millimeters. The scan resolution is 1.0 x 1.0mm or 1.5 x 1.5mm [default].
- » **Scan Width:** displays the width of the scan in centimeters. The Scan Width is 12-cm [default], unless Auto Centering fails, in which case the Scan Width is automatically set to 14-cm.
- » **Auto Centering:** when checked [default] (enabled), it centers the image in the region of interest despite small variances in actual patient orientation. For more information see "Auto Centering Mode" on page 11-65.
- » **Force mark points on-axis:** when checked (enabled), it forces the scanner to move on the X & Y axis only (will not allow scanning on a diagonal). When *not* checked (disabled) [default], it straightens the image in the region of interest despite small variances in actual patient orientation. To achieve the highest quality AP Spine scans, this feature should be DISABLED (unchecked). For more information see "Force Mark Points On-Axis" on page 11-66.
- » **Scan Speed:** The scan speed for a *High Precision* scan is 65mm/sec. The scan speed for *Standard* scan is 130mm/sec. [default] The scan speed for *High Speed* scan is 260mm/sec.

Preferences: Hip Scan

The following figure shows the default Hip Scan settings. The default settings should be effective for most scanning situations.

Hip		
	Scout	Measure
Resolution (mm)	1.0 X 4.0	1.0 X 1.0
Scan Width (cm)	12	9
Scan Length (cm)	12	9
<input checked="" type="radio"/> Standard Width <input type="radio"/> Extended Width		
Scan Speed	Standard 90 mm/sec ▼	

Figure 3-6: The default Hip Scan Parameters

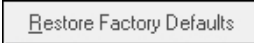
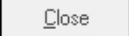
 **Note: WHAT TO DO:** To restore the *default* Scan parameters, click  and . This will restore the defaults for *all* scan types.

 **Note: WHAT TO DO:** To *change* the default Scan parameters, access the Scanner Preferences window from the main Database Navigator window as described next.

If it is not already open, click on **Edit > Scanner Preferences > Scanning** tab.

Locate the Hip scan parameters in the window (shown above).

Select and change any of the scan parameters, such as resolution, scan width, or speed.

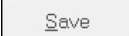
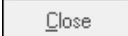
Click  and  at the bottom of the window. These settings now become the default settings until changed again.

PARAMETER DESCRIPTIONS:

- » **Resolution:** fixed for the Hip Scan
- » **Scan Width:** displays the width of the scan in centimeters.
Scout Scan: Standard Width 12 cm [default]
 Extended Width 16 cm (used for larger patients)
Measure Scan: Standard 9 cm [default]
 Extended Width 12 cm (used for larger patients)
- » **Scan Length:** *Scout* Scan fixed length = 12 cm
Measure Scan fixed length = 9 cm
- » **Standard Width / Extended Width** buttons: (see *Scan Width* above).
- » **Scan Speed:** The *Scout* Scan speed is fixed at 180mm/sec.
 The *Measure* Scan speed for *High Precision* is 45mm/sec.
 The *Measure* Scan speed for *Standard* is 90mm/sec [default].

Preferences: Forearm Scan

The following figure shows the default Forearm¹ Scan parameters. The default settings should be effective for most scanning situations.

Forearm		
	Scout	Measure
Resolution (mm)	1.0X1.0	1.0X1.0
Scan Width (cm)	<input type="text" value="8"/>	8
Scan Length (cm)	Up to Proximal	1.0
	<input type="radio"/> Distal <input type="radio"/> Proximal <input checked="" type="radio"/> Both	
Scan Speed	<input type="text" value="High Speed"/> <input type="text" value="20 mm/sec"/> ▼	

Figure 3-7: The default Forearm Scan Parameters



Note: WHAT TO DO: To restore the *default* Scan parameters, click and . This will restore the defaults for *all* scan types.



Note: WHAT TO DO: To *change* the default Scan parameters, access the Scanner Preferences window from the main Database Navigator window as described next.

If it is not already open, click on **Edit > Scanner Preferences > Scanning** tab.

Locate the Forearm scan parameters in the window (shown above).

Select and change any of the scan parameters, such as resolution, scan width, or speed.

Click and at the bottom of the window. These settings now become the default settings until changed again.

PARAMETER DESCRIPTIONS:

- » **Resolution:** is fixed
- » **Scan Width:** both *Scout* Scan and *Measure* Scan - operator defined [default setting is 8 cm]
- » **Scan Length:** The *Scout* scan length is "Up to proximal"
The *Measure* scan length is 1.0 cm
- » **Regions: Distal / Proximal / Both:** operator may elect to scan the *Distal* or *Proximal* forearm only, or *Both* the Distal and Proximal forearm
- » **Scan Speed:** The *Scout* scan speed is fixed at 45mm/sec
The *Measure* scan speed for *High Precision* is 2mm/sec
The *Measure* scan speed for *Standard* is 8mm/sec
The *Measure* scan speed for *High Speed* is 20mm/sec [default]

¹Forearm scan is not available on some models.

Preferences: Whole Body Scan

The following figure shows the default Whole Body¹ Scan parameters. The default settings should be effective for most scanning situations.

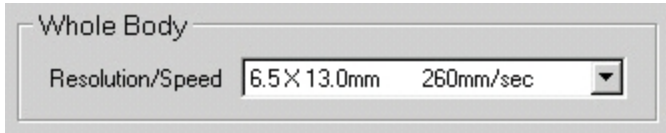

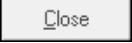



Figure 3-8: The default Whole Body Scan Parameters



 **Note:** WHAT TO DO: To restore the *default* Scan parameters, click  and . This will restore the defaults for *all* scan types.

 **Note:** WHAT TO DO: To *change* the default Scan parameters, access the Scanner Preferences window from the main Database Navigator window as described next.

If it is not already open, click on **Edit > Scanner Preferences > Scanning** tab.

Locate the Whole Body scan parameters in the window (shown above).

Select and change any of the scan parameters, such as resolution, scan width, or speed.

Click  and  at the bottom of the window. These settings now become the default settings until changed again.

PARAMETER DESCRIPTIONS:

- » **Speed / Resolution:** There are 6 possible combinations of speeds and resolutions. They are listed below. The default setting is *6.5 X 13.0mm @ 260mm/sec*.

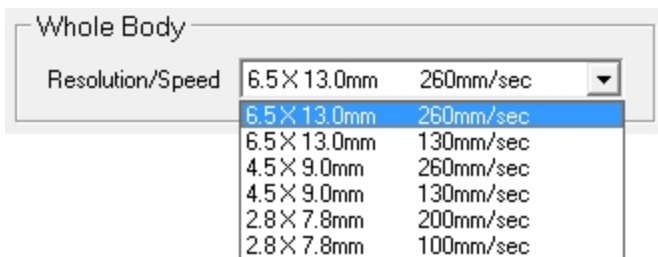

¹Whole Body Spine Scan is not available on some models.

Preferences: Lateral Spine Scan

The following figure shows the default Lateral Spine¹ Scan parameters. The default settings should be effective for most scanning situations.

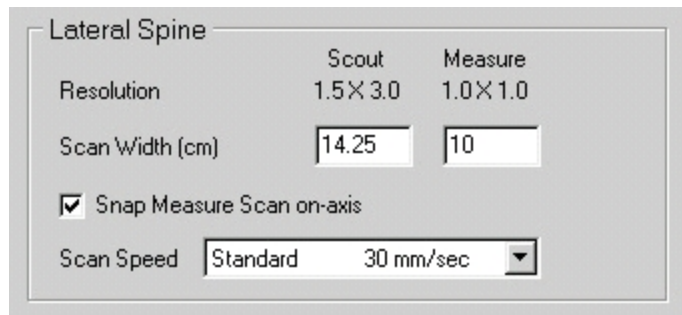

Figure 3-9: The default Lateral Spine Scan Parameters



Note: WHAT TO DO: To restore the *default* Scan parameters, click and . This will restore the defaults for *all* scan types.



Note: WHAT TO DO: To *change* the default Scan parameters, access the Scanner Preferences window from the main Database Navigator window as described next.

If it is not already open, click on **Edit > Scanner Preferences > Scanning** tab.

Locate the Lateral Spine scan parameters in the window (shown above).

Select and change any of the scan parameters, such as resolution, scan width, or speed.

Click and at the bottom of the window. These settings now become the default settings until changed again.

PARAMETER DESCRIPTIONS:

- » **Resolution:** fixed
- » **Scan Width:** *Scout* Scan width - operator defined [default setting is 14.25 cm]
Measure Scan width - operator defined [default setting is 10 cm]
A *Measure* Scan width of 8 cm is recommended for most female patients
A *Measure* Scan width of 9 cm is recommended for most male patients
- » **Snap Measure Scan on-axis:** box should be checked (enabled) [default] to force scans on axis
- » **Scan Speed:** The *Scout* scan speed is fixed at 130mm/sec
The *Measure* scan speed for *High Precision* is 15mm/sec
The *Measure* scan speed for *Standard* is 30mm/sec [default]
The *Measure* scan speed for *High Speed* is 60mm/sec

¹Lateral Spine scan is not available on some models.

Preferences: Research/Small Subject Scan

Prior to starting a Research or Small Subject¹ study, the scan parameters should be defined. The desired precision and detail of a scan, the scan length, and the time to scan completion influence the scan parameter selections.

In order to maintain precision and accuracy, always use the same scan parameters for serial scans.

The following figure shows the default Research/Small Subject Scan preferences.

	Scout	Measure
Resolution	3.0 X 3.0	1.0 X 1.0
Scan Speed (mm/sec)	60.0	60.0
Scan Width (cm)	13.8	10
<input checked="" type="checkbox"/> Scout Scan		<input checked="" type="checkbox"/> Force initial scan on-axis
Maximum degrees to snap final scan on-axis	15	
Research Scan Type Name	Research	
Sm Subject Scan Type Name	Sm Subject	

Figure 3-10: The default Research/Small Subject Scan Parameters



Note: WHAT TO DO: To restore the *default* Scan parameters, click and . This will restore the defaults for *all* scan types.



Note: WHAT TO DO: To *change* the default Scan parameters, access the Scanner Preferences window from the main Database Navigator window as described next.

If it is not already open, click on **Edit > Scanner Preferences > Scanning** tab.

Locate the Research/Small Subject scan parameters in the window (shown above).

Select and change any of the scan parameters, such as resolution, scan width, or speed.

Click and at the bottom of the window. These settings now become the default settings until changed again.

PARAMETER DESCRIPTIONS:

- » **Resolution:** values refer to point resolution (pixel size) x line spacing
- » **Scan Speed:** entered in mm/sec
Minimum for *Scout* and *Measure* scans is 1.0mm/sec
Maximum for *Scout* and *Measure* scans is 260.0mm/sec

¹Research and/or Small Subject are not available on some models.

-  **Note:** If the *Scan Speed* is too fast for the chosen *Resolution*, the following message will appear at the beginning of a scan:

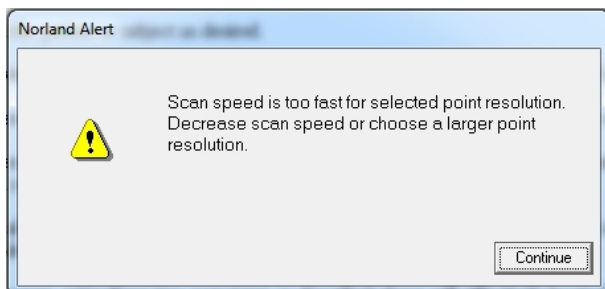

If this occurs, the *Scan Speed* must be reduced or the *Resolution* must be increased.

- » **Scan Width:** entered in centimeters.
Minimum for *Scout* and *Measure* scans is 2 x point resolution
Maximum for *Scout* and *Measure* scans is 255 x point resolution

-  **Note:** If the *Scan Width* is too large for the chosen *Resolution*, the following message will appear at the beginning of a scan:

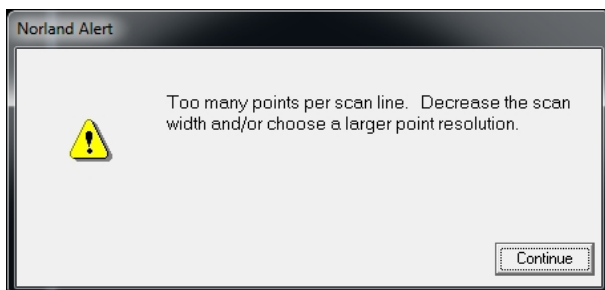

If this occurs, the *Scan Width* must be reduced or the *Resolution* must be increased.

- » **Scout Scan:** when enabled, provides image to assist in defining the Measure scan region
- » **Force initial scan on-axis:** forces end point of initial scan to be on same Y-axis as the start point
- » **Maximum degrees to snap final scan on-axis:** This field defines the maximum degree of rotation of the cursor box at the scan progress screen (following a scout scan) that will result in an on-axis scan. On-axis scans are faster than off-axis scans.
Rotation of the cursor box to an angle greater than or equal to the *Maximum degrees* setting will result in scan data collection at that angle. Rotation of the cursor box to an angle less than the *Maximum degrees* setting will result in an on-axis scan.
On-axis scans are scans taken with the start and end points on the same y-axis.
If the *Maximum degrees to snap final scan on-axis* is set to 15, then *Force on Axis* will correct scout view display for scout scans that are up to 15 degrees off axis.
- » **Scan Type Name:** operator-defined; default is “Research” or “Small Subject”

Analysis Tab Setup

The **Analysis** tab is accessed by clicking on **Edit > Scanner Preferences** in the main Database Navigator window. Then, click the **Analysis** tab.

The Analysis tab allows the operator to set several scan-specific analysis preferences. The analysis preferences available include: AP Spine, Hip, Forearm, Whole Body, Lateral Spine, and Research/Small Subject.¹

The default parameters for all the analysis operations are set and reset here. These setup options are typically reviewed and modified during system installation or during training. The different parameters are described in the next few sections.

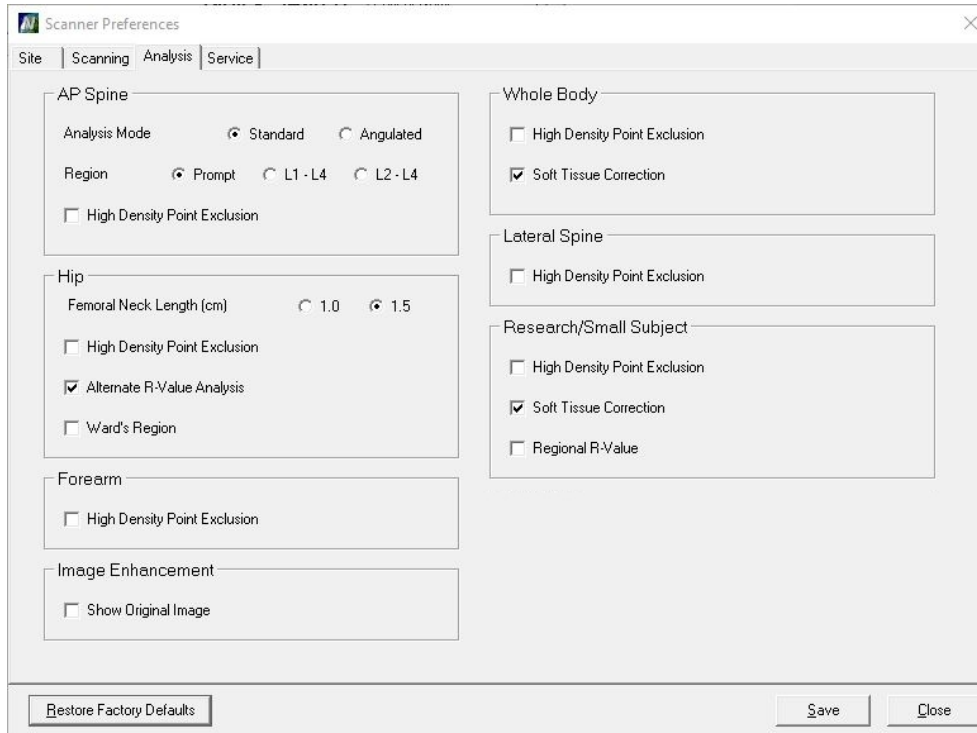

Figure 3-11: The Analysis tab preferences window

Preferences: Image Enhancement

When the “Show Original Image” option is unchecked (disabled), all scan images will use the enhanced display.

¹Forearm, Whole Body, Lateral Spine, and Research/Small Subject are not available on some models.

Preferences: AP Spine Analysis

The following figure shows the default AP Spine Analysis parameters. The default settings should be effective for most scanning situations.

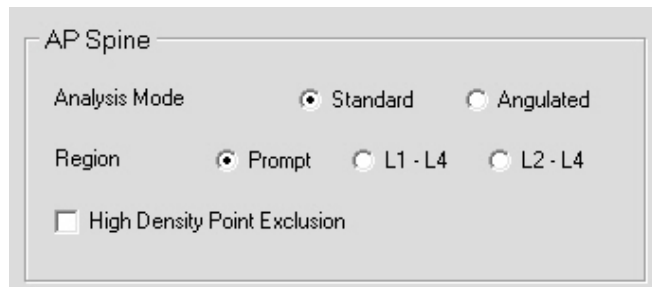

Figure 3-12: The default AP Spine Analysis Parameters



Note: WHAT TO DO: To restore the *default* Analysis parameters, click and . This will restore the defaults for *all* scan types.



Note: WHAT TO DO: To *change* the default Analysis parameters, access the Scanner Preferences window from the main Database Navigator window as described next.

If it is not already open, click on **Edit > Scanner Preferences > Analysis** tab.

Locate the AP Spine analysis parameters in the window (shown above).

Select and change any of the analysis parameters (see Parameter Descriptions below).

Click and at the bottom of the window. These settings now become the default settings until changed again.

PARAMETER DESCRIPTIONS:

- » **Analysis Mode:** refers to the cursors.
 - » The *Standard* option displays the cursors in the horizontal plane.
 - » The *Angulated* option allows the cursors to be positioned at whatever angle is necessary to line up on the vertebral gaps, such as would be needed for patients with angled spines. See "Angulated Cursors" on page 11-67.
- » **Region:** refers to the default region of interest for analysis. Select "Prompt" to make the selection each time a scan is analyzed. If "L1-L4" or "L2-L4" are selected it will be the default region of interest for all AP Spine scans.
- » **High Density Point Exclusion:** when checked (enabled), it will exclude data points with a density >3.75 g/cm² from the analysis. In addition, the note "HD Point Exclusion" will be printed under the scan image of the Bone Exam Report.



Caution: Norland strongly recommends operating the system with the High Density Point Exclusion box un-checked (disabled), in order to provide consistent results for trending. The option should only be turned on for individual scans when needed to remove artifacts from the scan.

Preferences: Hip Analysis

The following figure shows the default Hip Analysis parameters. The default settings should be effective for most scanning situations.

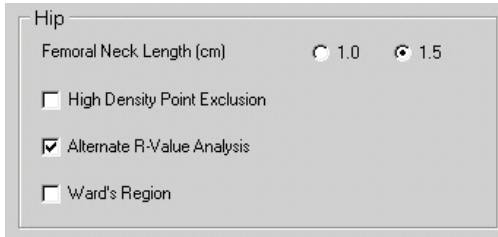

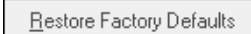
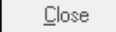



Figure 3-13: The default Hip Analysis Parameters

 **Note:** WHAT TO DO: To restore the *default* Analysis parameters, click  and . This will restore the defaults for *all* scan types.

 **Note:** WHAT TO DO: To *change* the default Analysis parameters, access the Scanner Preferences window from the main Database Navigator window as described next.

If it is not already open, click on **Edit > Scanner Preferences > Analysis** tab.

Locate the Hip analysis parameters in the window (shown above).

Select and change any of the analysis parameters (see Parameter Descriptions below).

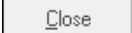
Click  and  at the bottom of the window. These settings now become the default settings until changed again.

PARAMETER DESCRIPTIONS:

- » **Femoral Neck Length:** Femoral Neck Length determines the length of the region of interest along the femoral neck axis. 1.5-cm is recommended because the longer length ensures better precision. The software will automatically default to 1-cm if unable to attain a 1.5-cm region.
- » **High Density Point Exclusion:** when checked (enabled), it will exclude data points with a density >3.75 g/cm² from the analysis. In addition, the note “HD Point Exclusion” will be printed under the image of the Bone Exam Report.

 **Caution:** Norland strongly recommends operating the system with the High Density Point Exclusion box un-checked (disabled), in order to provide consistent results for trending. The option should only be turned on for individual scans when needed to remove artifacts from the scan.

- » **Alternate R-Value Analysis:** if checked (enabled), the software algorithms will first use standard methods to analyze hip data. If the computed R-value is determined to be outside of an acceptable range, a second analysis method will automatically be invoked to analyze the hip scan data. An R-value is a computed value used during the analysis process to allow the software to estimate the amount of soft tissue above and below bone. In some individuals with very low density, the routine algorithms for calculating the “R” value do not allow for the proper processing of hip data.
- » **Ward’s Region:** is the minimum BMD Region automatically defined by the software. It is un-checked (disabled) by default.

Preferences: Forearm Analysis

The following figure shows the default Forearm Analysis parameters. The default settings should be effective for most scanning situations.

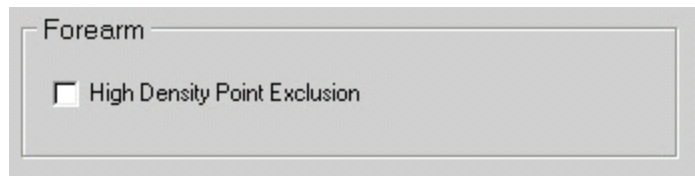

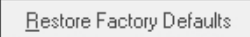
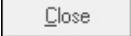



Figure 3-14: The default Forearm Analysis Parameters

 **Note:** WHAT TO DO: To restore the *default* Analysis parameters, click  and . This will restore the defaults for *all* scan types.

 **Note:** WHAT TO DO: To *change* the default Analysis parameters, access the Scanner Preferences window from the main Database Navigator window as described next.

If it is not already open, click on **Edit > Scanner Preferences > Analysis** tab.

Locate the Forearm analysis parameters in the window (shown above).

Select and change any of the analysis parameters (see Parameter Descriptions below).

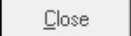
Click  and  at the bottom of the window. These settings now become the default settings until changed again.

PARAMETER DESCRIPTIONS:

- » **High Density Point Exclusion:** when checked (enabled), it will exclude data points with a density >3.75 g/cm² from the analysis. In addition, the note “HD Point Exclusion” will be printed under the image of the Bone Exam Report.

 **Caution:** Norland strongly recommends operating the system with the High Density Point Exclusion box un-checked (disabled), in order to provide consistent results for trending. The option should only be turned on for individual scans when needed to remove artifacts from the scan.

Preferences: Whole Body Analysis

The following figure shows the default Whole Body Analysis parameters. The default settings should be effective for most scanning situations.

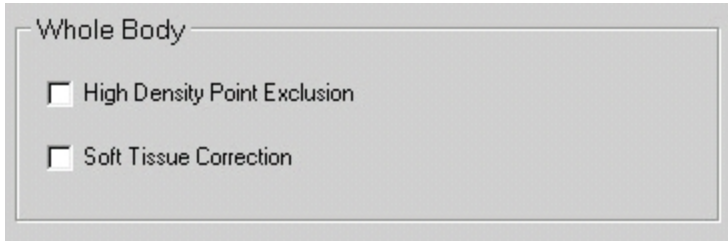

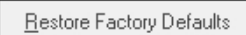
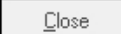



Figure 3-15: The default Whole Body Analysis Parameters

 **Note:** WHAT TO DO: To restore the *default* Analysis parameters, click  and . This will restore the defaults for *all* scan types.

 **Note:** WHAT TO DO: To *change* the default Analysis parameters, access the Scanner Preferences window from the main Database Navigator window as described next.

If it is not already open, click on **Edit > Scanner Preferences > Analysis** tab.

Locate the Whole Body analysis parameters in the window (shown above).

Select and change any of the analysis parameters (see Parameter Descriptions below).

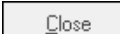
Click  and  at the bottom of the window. These settings now become the default settings until changed again.

PARAMETER DESCRIPTIONS:

- » **High Density Point Exclusion:** when checked (enabled), it will exclude data points with a density >3.75 g/cm² from the analysis. In addition, the note “HD Point Exclusion” will be printed under the scan image of the Bone Exam Report.

TO EXCLUDE HIGH DENSITY OBJECTS FROM THE ANALYSIS: The system software is equipped with a feature that will exclude high density objects from the analysis. This feature is normally disabled (unchecked). It can be enabled (checked) for all scans (default setting) by following the steps below.

Determine if the patient has had any dental work, implants, or any sub-dermal high density objects. These objects may affect the results of the scan.

In the Whole Body area of the Analysis tab, click the check box labeled High Density Point Exclusion (Figure 3-15). When checked, the Analysis will exclude data points with a density greater than 3.75 g/cm².

 **Caution:** Remember to disable High Density Point exclusion at the completion of the scan.

- » **Soft Tissue Correction:** For scanners with Soft Tissue Calibration enabled, the Soft Tissue Correction will be applied to the Fat and Lean mass measurements.

Preferences: Lateral Spine Analysis

The following figure shows the default Lateral Spine Analysis parameters. The default settings should be effective for most scanning situations.

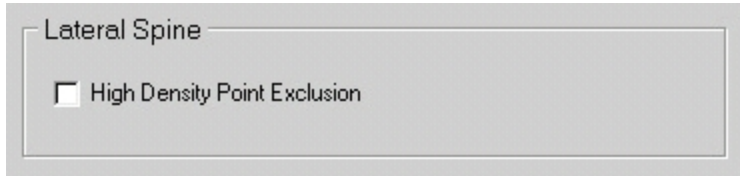

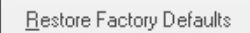
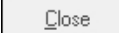



Figure 3-16: The default Lateral Spine Analysis Parameters



 **Note: WHAT TO DO:** To restore the *default* Analysis parameters, click  and . This will restore the defaults for *all* scan types.

 **Note: WHAT TO DO:** To *change* the default Analysis parameters, access the Scanner Preferences window from the main Database Navigator window as described next.

If it is not already open, click on **Edit > Scanner Preferences > Analysis** tab.

Locate the Lateral Spine analysis parameters in the window (shown above).

Select and change any of the analysis parameters (see Parameter Descriptions below).

Click  and  at the bottom of the window. These settings now become the default settings until changed again.

PARAMETER DESCRIPTIONS:

- » **High Density Point Exclusion:** when checked (enabled), it will exclude data points with a density >3.75 g/cm² from the analysis. In addition, the note “HD Point Exclusion” will be printed under the scan image of the Bone Exam Report.

 **Caution:** Norland strongly recommends operating the system with the High Density Point Exclusion box un-checked (disabled), in order to provide consistent results for trending. The option should only be turned on for individual scans when needed to remove artifacts from the scan.

Preferences: Research/Small Subject Analysis

The following figure shows the default Research/Small Subject Analysis parameters. The default settings should be effective for most scanning situations.

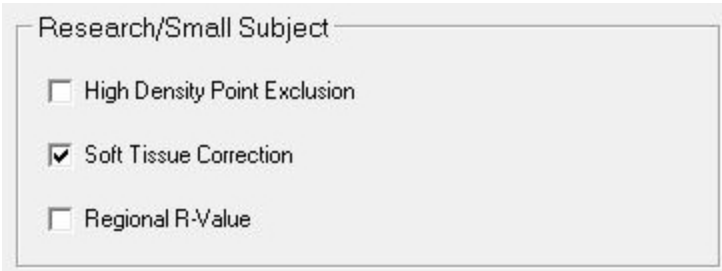

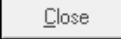



Figure 3-17: The default Research/Small Subject Analysis Parameters

 **Note:** WHAT TO DO: To restore the *default* Analysis parameters, click  and . This will restore the defaults for *all* scan types.

 **Note:** WHAT TO DO: To *change* the default Analysis parameters, access the Scanner Preferences window from the main Database Navigator window as described next.

If it is not already open, click on **Edit > Scanner Preferences > Analysis** tab.

Locate the Research/Small Subject analysis parameters in the window (shown above).

Select and change any of the analysis parameters (see Parameter Descriptions below).

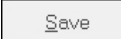
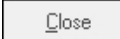
Click  and  at the bottom of the window. These settings now become the default settings until changed again.

PARAMETER DESCRIPTIONS:

- » **High Density Point Exclusion:** when checked (**enabled**), it will exclude data points with a density >3.75 g/cm² from the analysis. In addition, the note “HD Point Exclusion” will be printed under the scan image of the Bone Exam Report.

IF HIGH DENSITY POINT EXCLUSION IS CHANGED FOR A COMPLETED SCAN: The scan will be reanalyzed, and the user will be prompted for the reanalysis type.

A **Full** Analysis will retain all user-placed regions. Any areas Included or Excluded from the scan will be reset to normal data points.

A **Partial** Analysis will retain all user-placed regions, as well as retain any Included or Excluded areas.

The **Cancel** option will revert to the previous setting for the High Density Point Exclusion setting, and the scan data will not be modified.

 **Caution:** Norland strongly recommends operating the system with the High Density Point Exclusion box un-checked (disabled), in order to provide consistent results for trending. The option should only be turned on for individual scans when needed to remove artifacts from the scan.

- » **Soft Tissue Correction:** For scanners with Soft Tissue Calibration enabled, the Soft Tissue Correction will be applied to the Fat and Lean mass measurements.
- » **Regional R-Value:** Analyzed scans using individual R-Values for each Region of Interest, instead of a global R-Value.



Note: The same R-Value setting should be used for all scans of the same study for a patient to produce consistent results.

Service Tab Setup



Caution: The Service Setup should not be modified by operators without direct communication from an authorized Norland Technical Support Representative.

The Site tab is accessed by clicking on **Edit > Scanner Preferences**. Then click the Service tab.

Here, the operator can view the serial numbers for the Calibration Standard, Scanner and the QC Phantom.

The operator can set the type of file that calibration reports are exported to here. The default destination is to a PDF file. Calibration files can also be exported to a DICOM file but only if the DICOM interface has been enabled.

The operator can also disable the instructions for performing a calibration. This will allow the calibration screen to be displayed much faster. However, this is not recommended unless the operator is well versed in the calibration technique.

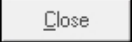
Click  to close the window.

The Service tab preferences window

Scanner Preferences

Site | Scanning | Analysis | **Service**

Calibration Standard

Calibration Standard S/N: Scanner S/N: 8128

K-Values

K1: K3:
 K2: K4:
 K5:

T-Values

T1: T3:
 T2: T4:
 T5:

QC Phantom

QC Phantom S/N:

BMD: BMD SD:
 Fat: Fat SD:
 Lean: Lean SD:

Export Reports To DICOM
 Disable System Calibration Instructions

Advanced Preferences Command

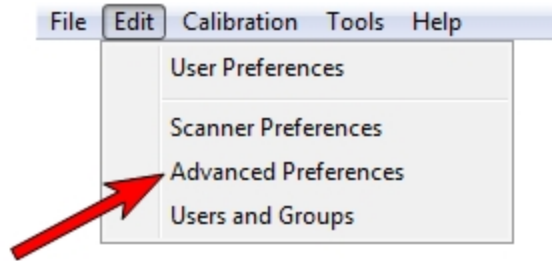

The Advanced Preferences selection displays a few different tabbed dialog boxes. The tabs of interest include the *Basic Settings* tab, the *Reporting* tab, the *Directories* tab, and the *Network* tab.

System Tab (under the Basic Settings tab)

If the setting **Always Display Reference Graphs in Color?** is enabled, the reference graphs on all screens and reports will always be displayed in color. If the setting is disabled and the Image Color is set to Grayscale, reference graphs will also be displayed in grayscale.

Customer Info Tab (under the Basic Settings tab)

The fields in the Customer Info tab provide the business name and address information that will be printed at the top of the calibration reports and some patient scan reports.

Click on **Edit > Advanced Preferences** and click on the Basic Settings tab, then the Customer Info tab to open the following window:

 A screenshot of the 'Advanced Preferences' dialog box. The title bar reads 'Advanced Preferences'. The main window has several tabs: 'Basic Settings', 'Reporting', 'Directories', 'Network', 'Study', and 'DICOM'. The 'Basic Settings' tab is active, and within it, the 'Customer Info' sub-tab is selected. The form contains the following fields:

- Business Name: Bridgeport X-ray Lab
- Locality: Bridgeport, CT
- Department: X-ray
- Phone: 203-555-1212
- FAX: 203-555-1414
- Email: BptXrayLab@earthlink.net
- Address: 555 Main Street
- City: Bridgeport
- State: CT
- Postal Code: 12345
- Country: USA

 On the right side of the dialog, there are two buttons: 'Done' and 'Cancel'.

Printing Tab (under the Reporting tab)

The Printing tab allows the user to set the print margins when printing Reports.

Click on **Edit > Advanced Preferences** and click on the Reporting tab:

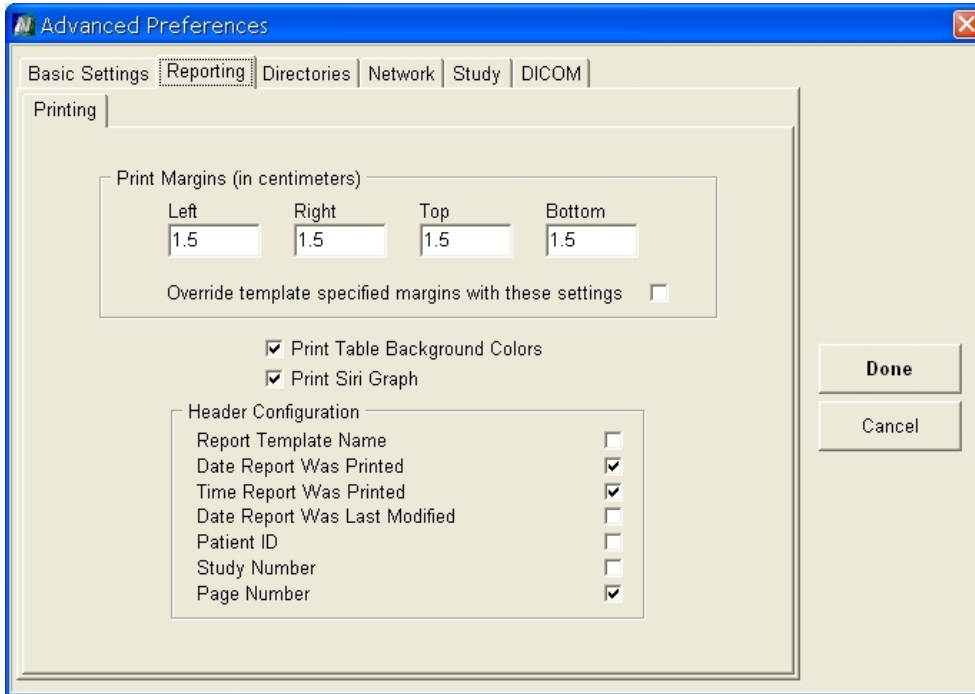

Enabling the **Print Siri Graph** option will show the Siri UWE Fat Table on Whole Body reports when Soft Tissue Composition is enabled. When disabled, the graph will not appear on any report layout.

Directories Tab

The Directories tab is where the various paths are set.

Click on **Edit > Advanced Preferences** and click on the Directories tab to open the following window:

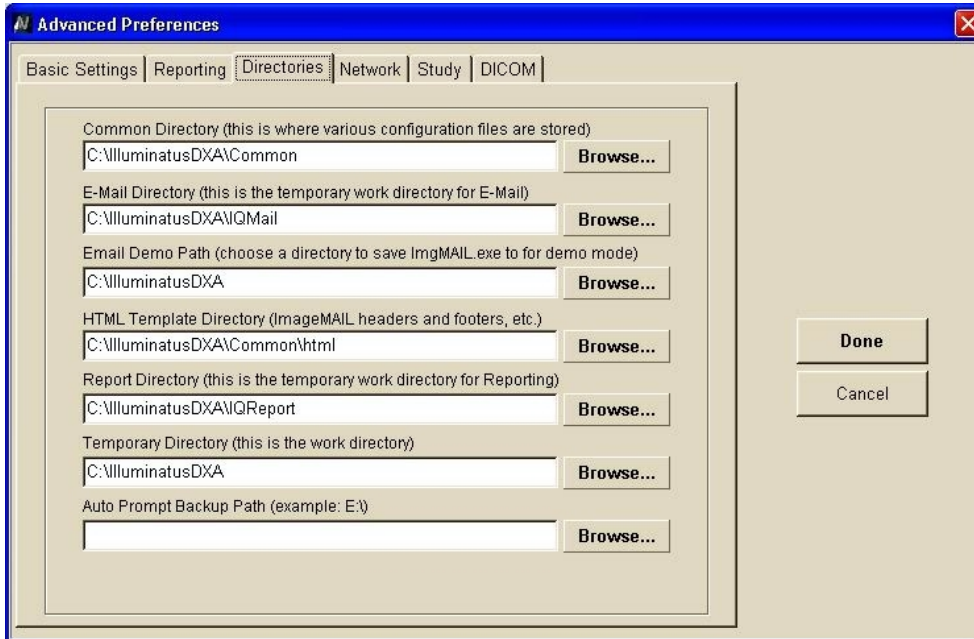

NOTE: A path MUST be entered in the “E-Mail Directory” box in order for the FolderMail option to work.

Directory Settings for the MAPI Server Type

Follow this procedure to set the proper directory path when using a **MAPI** server type.

Click on **Edit > Advanced Preferences** and click on the Directories tab to open the following window:

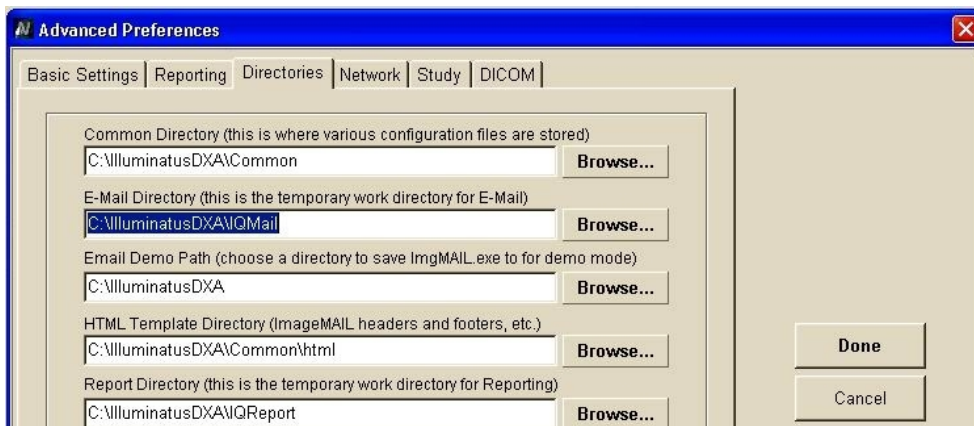

Click on the Browse button as marked above (to change the E-Mail Directory path).

Click on the series of folders as shown below to get to the **1033** folder. NOTE: you must double click on the folder icon to select the folder. (Notice the path at the bottom of the window.)

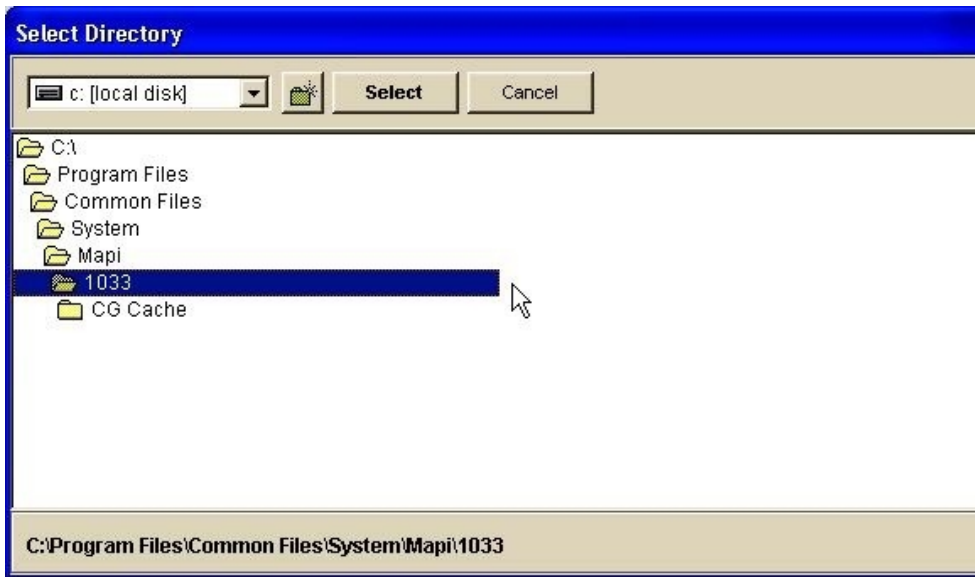

Once there, click **Select**. That path now appears in the Directories tab. Click .

Network Tab

The Network tab allows your IT administrator to enter the SMTP Server host name.

Click on **Edit > Advanced Preferences** and click on the **Network** tab to open the following window:

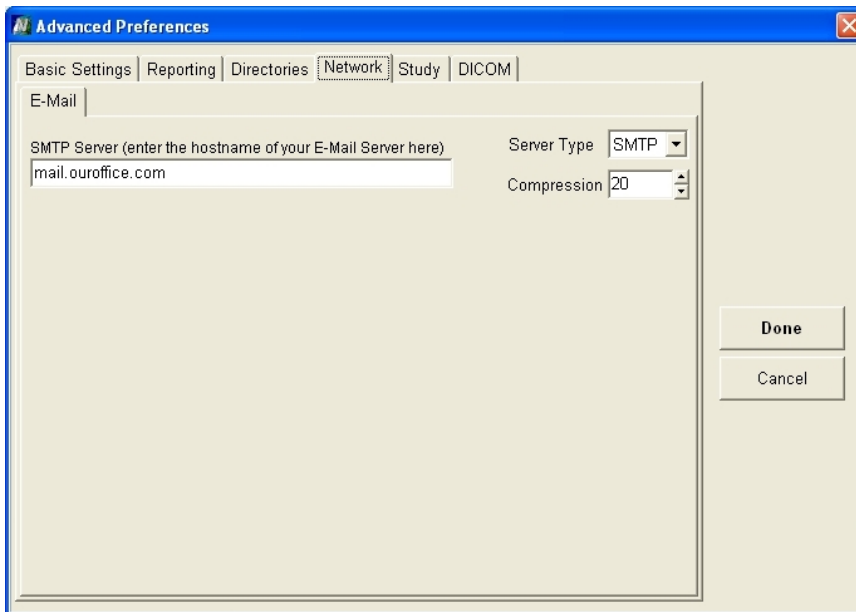

To set the mail configuration:

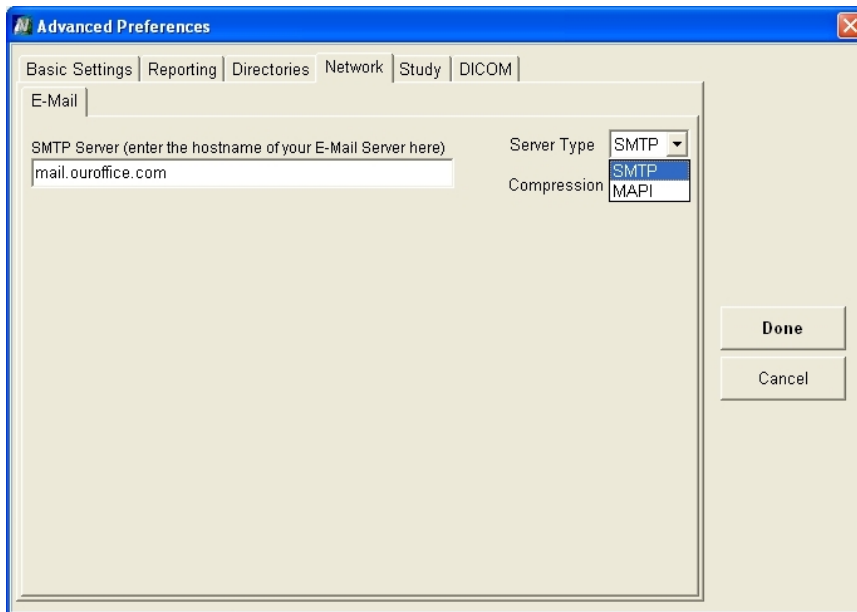

Selecting the **Server Type** "SMTP" (from the drop-down list) will require that the SMTP server (host name of the server) be entered in the white box labeled **SMTP Server** as shown above. The setting *mail.ouroffice.com* was used in this example.

Selecting the **Server Type** "MAPI" (from the drop-down list) will use your current e-mail client (i.e. it will invoke Outlook or Outlook Express). Go to "Directory Settings for the MAPI Server Type" on page 3-42 to set the correct directory path when using the MAPI server type.

Users and Groups Command

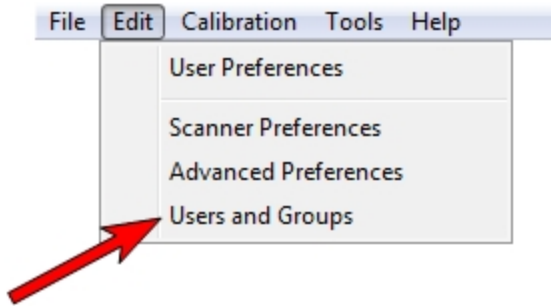

The Users and Groups selection displays the User Editor dialog box. It contains two higher level tabs - a Users tab and a Groups tab.

The Users tab contains the following sub-tabs:

Main Settings - displays the dialog box for changing login name and password, e-mail address, and the width and height of the Stamp View thumbnail

User's Groups - contains the Group List

Additional Settings - has Security Privileges settings

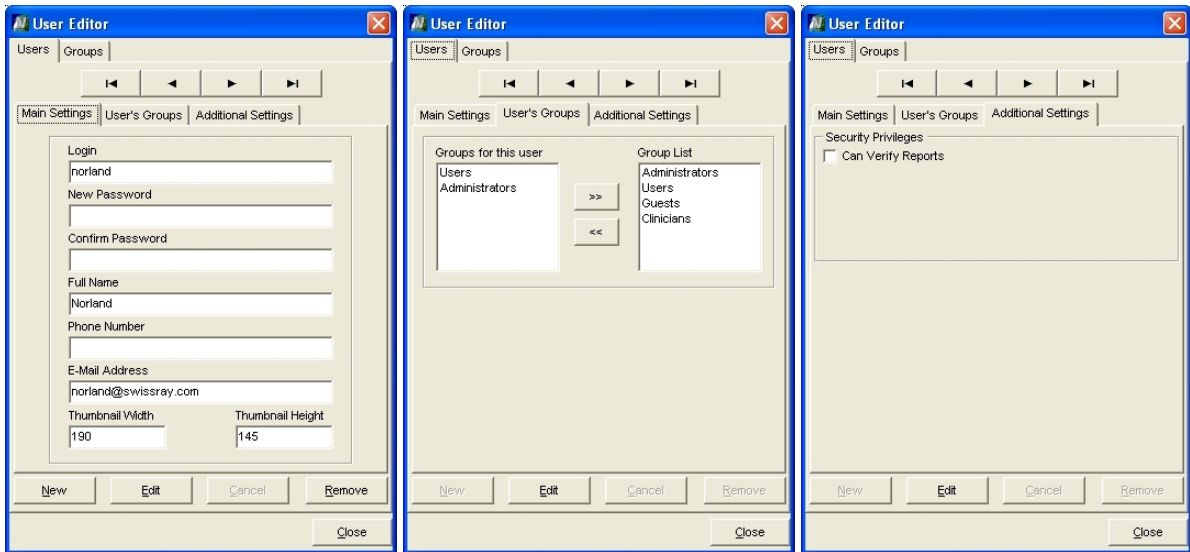

Note: WHAT TO DO: Select the tab related to the function you want to perform. Type in the information being changed. Click the appropriate button (New, Edit, Cancel, or Remove). Click .

The Groups tab contains the Group List:

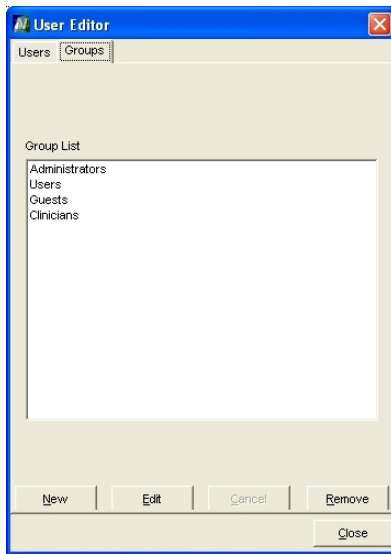

Note: WHAT TO DO: Select the tab related to the function you want to perform. Type in the information being changed. Click the appropriate button (New, Edit, Cancel, or Remove). Click .

Calibration Command

To view the Calibration commands, click on Calibration in the Database Navigator window.

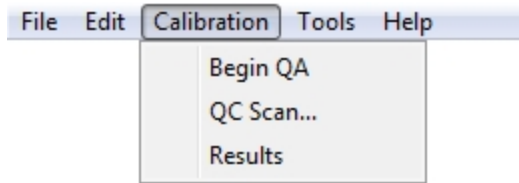

Quick Descriptions: “Calibration” drop-down list

Begin QA: initiates the QA procedure, which is performed daily. See "Daily Calibration Procedure" on page 4-6 for the complete QA procedures.

QC Scan: prepares the system for a scan of the QC Phantom (independent of the QA procedure).

Results: displays most recent QA results. See "QA Results tab Window Interpretation" on page 4-18.

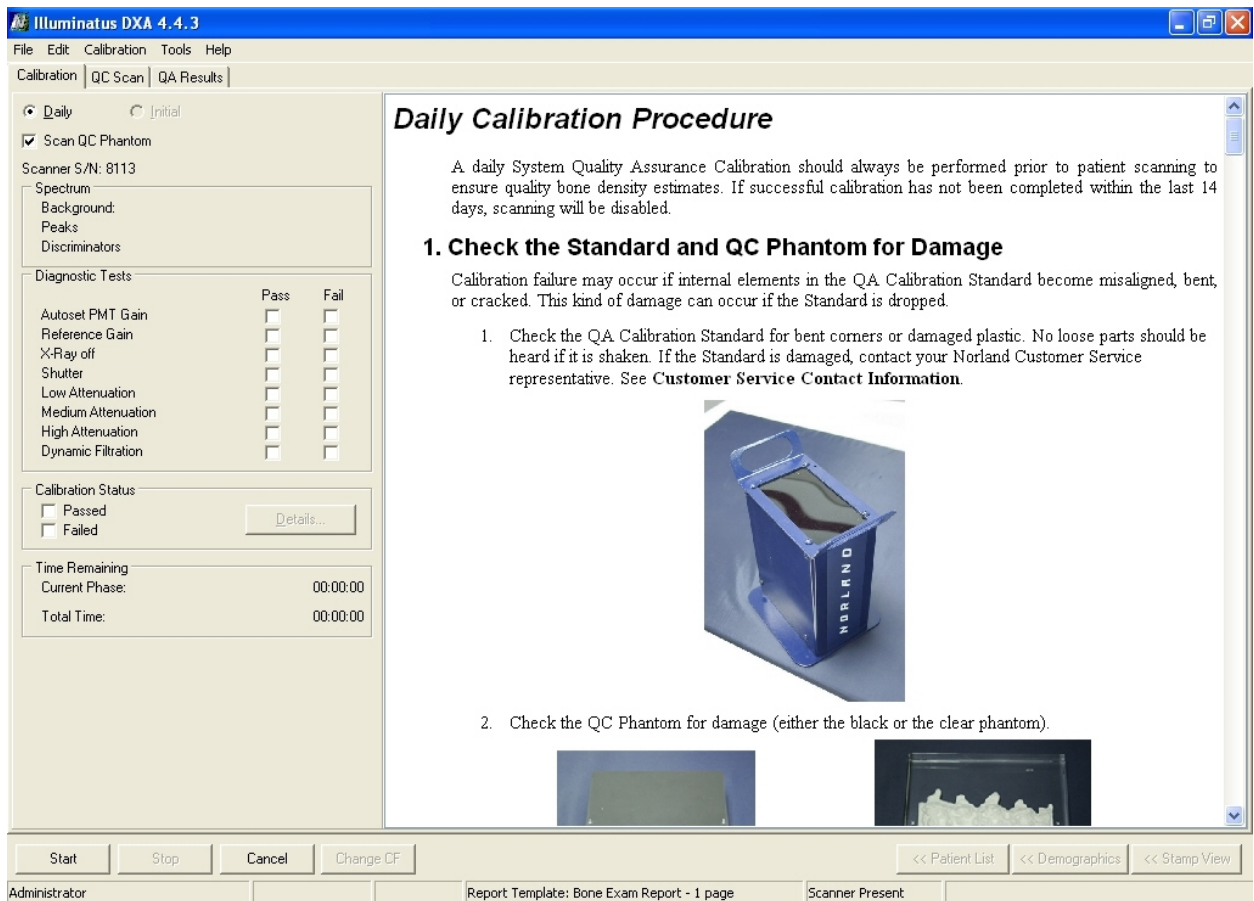
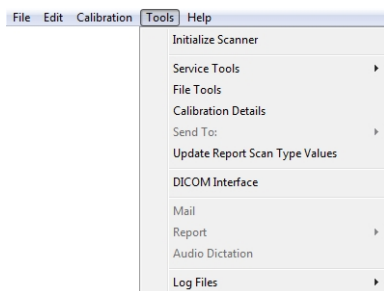

Figure 3-18: Preparing for a Daily Calibration by selecting **Calibration > Begin QA**.

Tools Command

To view the Tools commands, click on Tools in the Database Navigator window.



Quick Descriptions: “Tools” drop-down list

Initialize Scanner: Select this feature if the message “Scanner Not Present” appears at the bottom of the Database Navigator window and the scanner is powered on. The Scanner will re-initialize.

Service Tools: contains the **Find Origin**, **Table Limits**, and **Begin Initial Calibration** commands. See "Find Origin" on the facing page, "Table Limits" on page 3-50, or "Begin Initial Calibration" on page 3-51 for details.

File Tools: for detailed patient and scan information and system diagnostics files.

Calibration Details: for system diagnostics. Various calibration files can be viewed.

Send To: This (cascading) menu option provides a way for operators to copy a Scan from the Bone Densitometer software to any of the drives (e.g., C:\, floppy, network share), or a folder. From the Stamp View, the operator should select one or more scans, select **Tools > Send To**, and select the drive of choice in the sub-menu.

Update Report Scan Type Values: This command will update the scan types on all previously generated reports in all databases. The command will disappear from the menu once it has been executed once.

DICOM Interface: This command will launch the DICOM Interface. Refer to **Chapter 13, DICOM Interface** for more information. The option will only be available if enabled by an OAC.

Mail: This tool enables the operator to e-mail patient data in a FolderMail file to a colleague. It also displays the E-mail address book. Refer to "FolderMAIL" on page 11-9 for information.

Report: This selection enables the operator to select a report template, generate a new report, and edit existing Reports (*Complete Report* command). Full instructions on how to generate and print a report is included at the end of each type of scan chapter (for example "Generate and Print a Report" on page 7-24 for AP Spine scans).

Audio Dictation: An **Audio Dictation** enables a person to record anything, including a report dictation pertaining to the selected scan that can be written up later. Refer to "Adding Audio to a Patient Record" on page 11-2 for info.

Log Files: This pull-down provides a secondary menu allowing the administrator to access the following log files:

- » **Scanner:** errors.log
- » **Calibration:** calib.trc
- » **Import DB:** dbimport.log
- » **Runtime:** client.log

Find Origin

This setting is accessed by clicking **Tools > Service Tools > Find Origin**.

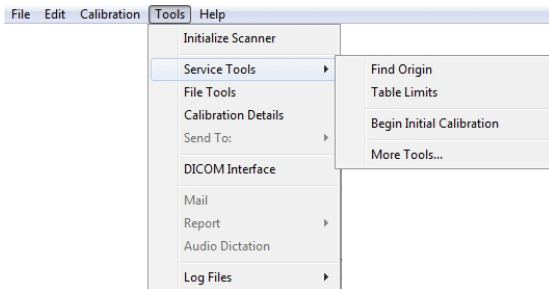

The "Find Origin" command is a diagnostic function that allows operators to redefine system origin location if the arm was bumped during operation (thus losing a step) or if Technical Support requests this operation during troubleshooting efforts. It moves the scanner arm to the origin at the left rear corner of the machine. A dialog box opens warning the user that the table origin will be found and the patient should be kept out of the way. The operator has the option to continue or cancel the operation.



Caution: Ensure that Scanner Arm path is clear of obstructions before using this feature.



Note: **WHAT TO DO:** Click on **Tools > Service Tools > Find Origin**. The following alert box opens:

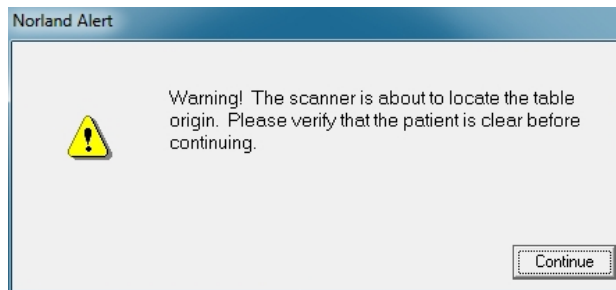

Click to continue. The scanner arm will find the origin.

Table Limits

This setting is accessed by clicking **Tools > Service Tools > Table Limits**.

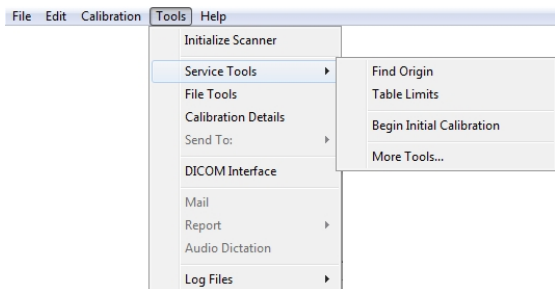

The "Table Limits" command is a diagnostic function that allows operators to redefine table limits if the arm was bumped during operation (thus losing a step) or if Technical Support requests operation during troubleshooting efforts. It moves the scanner arm to the origin position and to the opposite corner to define the scan area. A dialog box opens warning the operator that the table dimensions will be found and the patient should be kept out of the way. The operator has the option to continue or cancel the operation.

 **Caution:** Ensure that Scanner Arm path is clear of obstructions when using this feature.

 **Note:** WHAT TO DO: Click on **Tools > Service Tools > Find Origin**. The following alert box opens:

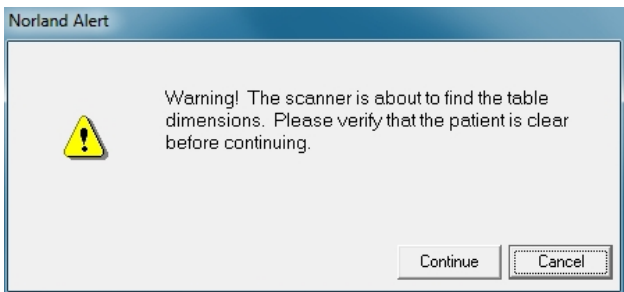

Click  to continue. The scanner arm will redefine the table limits.

Begin Initial Calibration

This setting is accessed by clicking **Tools > Service Tools > Begin Initial Calibration**.

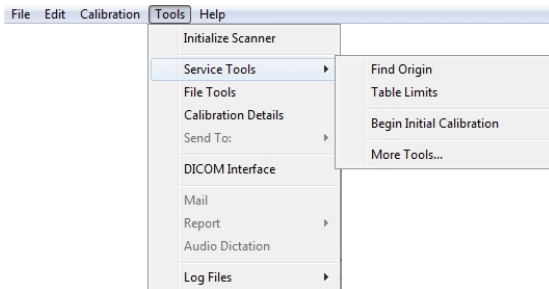

The Begin Initial Calibration command is a tool that allows Technical Support to begin the Initial Calibration process for repair purposes. The command should only be used under the direction of Technical Support. The calibration process will run for a minimum of 6 hours, and once the process is started, it is not possible to scan patients until it has completed successfully.



Note: WHAT TO DO: Click on **Tools > Service Tools > Begin Initial Calibration**. The following alert box opens:

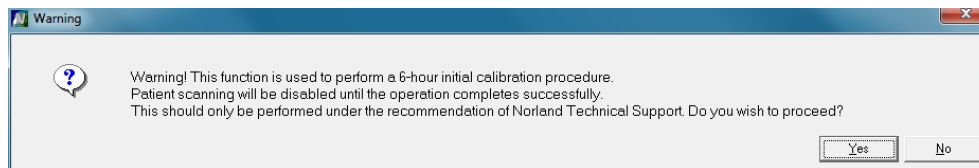

Click to continue. You will be prompted again to confirm. Click again to continue.

Help Command

To view the Help commands, click on Help in the Database Navigator window.

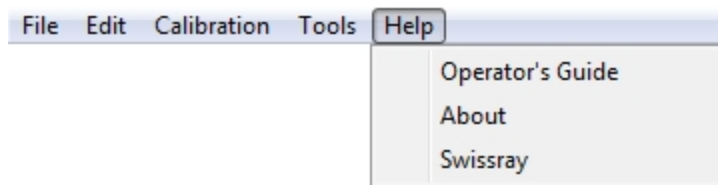

Quick Descriptions: "Help" drop-down list

Help Topics: opens the Illuminatus Operator's Guide.

About: opens a window describing information about the Illuminatus software and the copyright.

Swissray: opens a link to the Swissray Web page <http://www.swissray.com> (if connected to the internet).

CHAPTER 4

Basic Operation

This chapter begins with an overview of the patient scanning procedure. Guidelines for obtaining scan precision and accuracy are reviewed next.

System Startup procedures for the scanner are detailed next. After startup, detailed instructions for the Daily System Quality Assurance Calibration Procedures are presented. A discussion of the QA Results follows.

Preparing patient records is the next step in the scanning procedure. How to create a new patient record and how to update an existing patient's record are discussed in detail. From there, you are instructed to go to the pertinent scan-type chapter (AP Spine, Hip Scan, etc.) to continue the scan.

A discussion of the buttons and fields available in the Patient Demographics window is given for reference.

Finally, system backup and shutdown procedures are discussed.

This chapter discusses the following.

Patient Scanning Procedure Overview	4-2
Guidelines for Attaining Precision and Accuracy	4-2
Powering Up the System	4-3
Logging into the Norland Software	4-4
Daily Calibration Procedure	4-6
QA Results tab Window Interpretation	4-18
Preparing Patient Records	4-21
Beginning the Patient Scan	4-33
System Shutdown	4-34

Patient Scanning Procedure Overview

The Norland DXA system quantifies bone mineral in the lumbar spine, hip, lateral spine, and whole body for computer and operator-defined regions of interest. The software automatically programs the system for the correct techniques and parameters based on the selected scan type.

1. The operator selects an existing patient's name from the Database Navigator window or enters a new patient's information into the Patient Demographics window.
2. The patient is positioned on the scan table, and a scan type is selected from the software.
3. The operator positions the scanner arm to the patient's anatomy and defines the scan region. (A scout scan is used on some scans to assist in defining the scan region.)
4. The actual scan completes without interruption or operator intervention. An audible indicator sounds at the end of each scan.
5. After the scan has completed, the operator can analyze the scan immediately or save the scan data and analyze it later.
6. After scan analysis is completed, the results are saved to a default storage location and printed or sent to DICOM.

Guidelines for Attaining Precision and Accuracy

Patient variability, operator techniques and external radiation may adversely affect the precision and accuracy of DXA estimations. It is not possible to eliminate all of these factors. However, the operator can reduce their effects on scans by following these guidelines:

- » Perform the Daily Quality Assurance Calibration.
- » Screen patients for recent radionuclide uptake procedures (within ten half-lives).
- » Make sure that each operator follows the same procedure for patient positioning and analysis. If the patient has been scanned before, use the same scan parameters as those used for the patient's initial scan. Use the same scan area size for all scans of the same patient.



Be aware that operating a Norland system near external radiation sources, such as other x-ray generating devices or devices that involve radionuclides, may affect results.

Powering Up the System

Norland Bone Densitometers do not require any warm-up period before calibration or patient scanning. Norland Technical Support recommends that the scanner system be left ON overnight and weekends. The scanner system should be turned OFF if the system is to be inactive for an extended time (1 week or longer).

Norland **STRONGLY** recommends that the QA Calibration be performed daily prior to patient scanning as part of a regular Quality Assurance Program.

The operator should follow these instructions to power up the Norland Bone Densitometer system after it has been shut down.



IMPORTANT: The scanner **MUST** be turned on **BEFORE** entering the IlluminatusDXA software for proper operation.



Figure 4-1: Scanner Table Power Switch Location

1. Turn the scanner ON by depressing the power switch located on the lower inside right panel.
2. Turn on the computer and the monitor. The computer will boot into the Windows desktop with the Bone Densitometer Host icon displayed on the desktop.
3. Turn on the printer.
4. Log in to the IlluminatusDXA program.

Logging into the Norland Software

1. Double-click on the “Illuminatus DXA” icon  on the desktop to start the Norland Bone Densitometer software program. The Login window will open, as shown next.

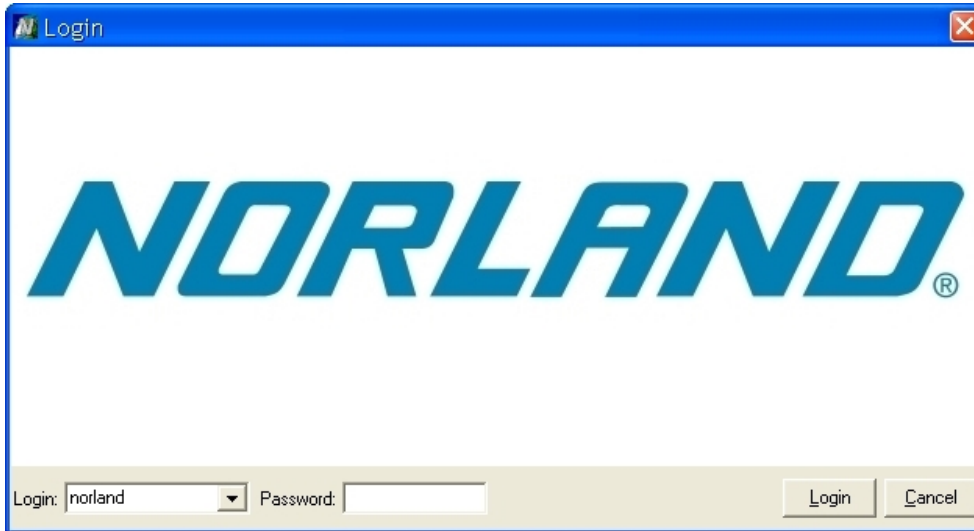



Figure 4-2: The Bone Densitometer Login window

2. Type in the password and click the  button to start the software.
3. If the scanner was previously turned off and back on, you will be prompted to initialize the scanner. Wait while the Scanner initializes.



Caution: The Scanner Arm will move to its origin position during initialization. STAY CLEAR OF THE SCANNER ARM.

4. The software will open to the main window - referred to in this manual as the **Database Navigator** window. It is shown next for reference.

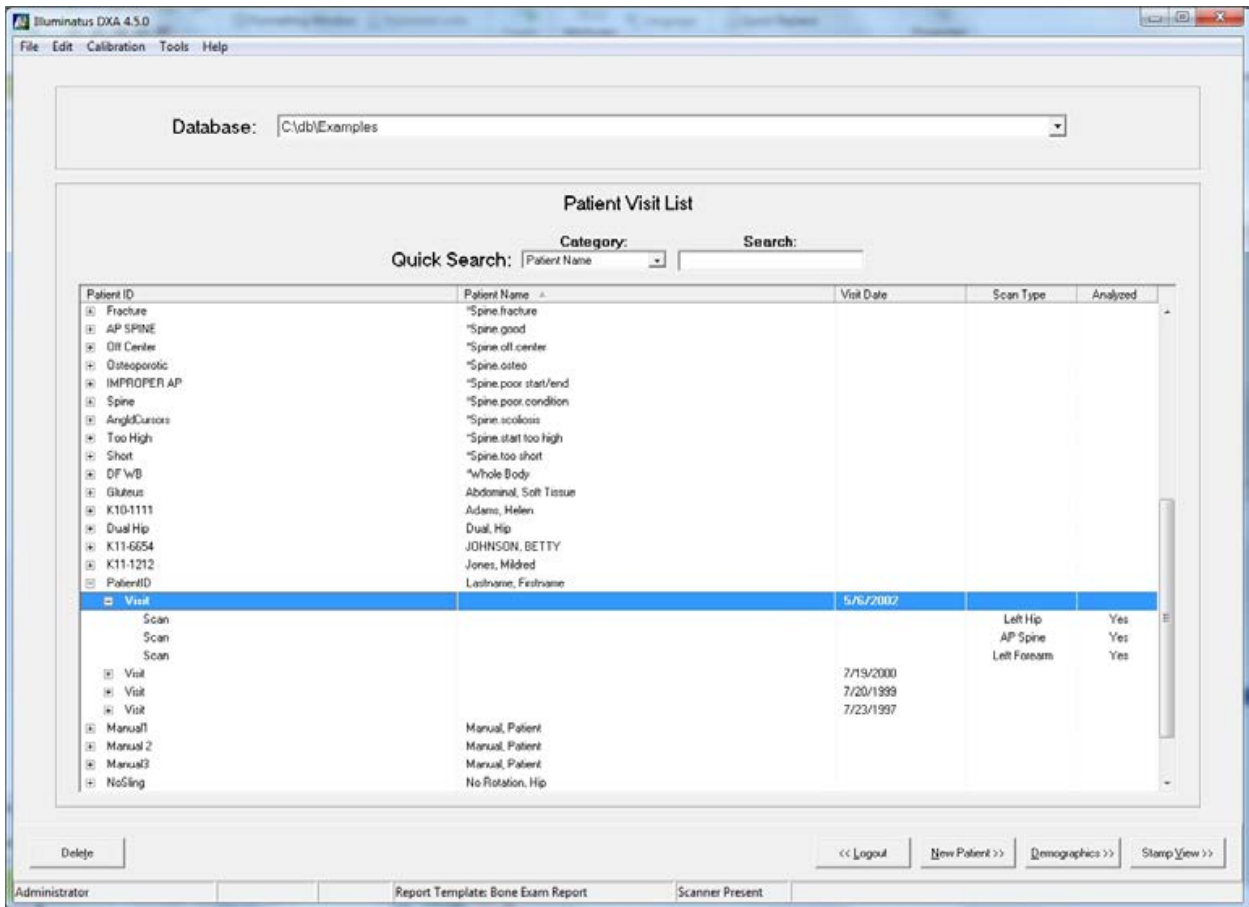

Figure 4-3: The main Database Navigator window

The Norland software is now ready to:

- » perform a System Calibration
- » perform a patient scan or
- » perform an analysis on an existing scan

To ensure a high level of precision and accuracy, a System Calibration should be performed at the beginning of the day when patient scans will occur. The daily system calibration procedures are described on the next few pages.



In the event of a start up problem or other difficulty, please contact your Norland Technical Support Representative.

Daily Calibration Procedure



Note: A daily System Quality Assurance Calibration must always be performed prior to patient scanning to ensure quality scan results. If a successful calibration has not been completed within the last 14 days, scanning will be disabled.

1. Check the Standard and QC Phantom for Damage

Calibration failure may occur if internal elements in the QA Calibration Standard become misaligned, bent, or cracked. This kind of damage can occur if the Standard is dropped.

- a. Check the QA Calibration Standard for bent corners or damaged plastic. No loose parts should be heard if it is shaken. If the Standard is damaged, contact your Norland Technical Support representative. See "Customer Service Contact Information" on page 1-3.



Figure 4-4: QA Calibration Standard

- b. Check the QC Phantom for damage.



Figure 4-5: Body Composition QC Phantom

2. Position the Standard and the Phantom on the Scanner

- a. Place the QA Calibration Standard on the scanner table and position it so that it is aligned with the corresponding marks on the scanner table surface. Point "A" on the calibration standard will face the head (to the right) of the table.



Figure 4-6: Positioning the QA Calibration Standard and QC Phantom

- b. Place the black QC Phantom on the scanner table in the marked location. The "C" on the box should be oriented to the right side of the table (operator facing the table). Position the Phantom parallel to the back rest.

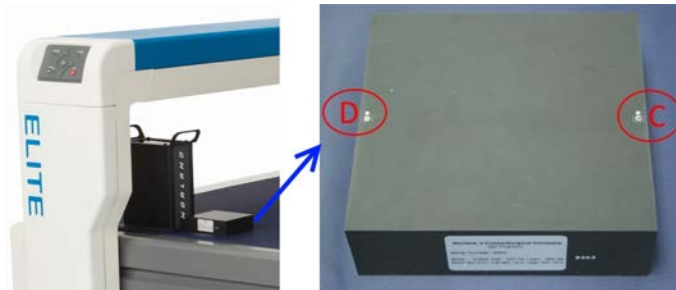

3. Calibrate the System Using the QA Calibration Standard

- a. In the Database Navigator window, click **Calibration > Begin QA**. The Calibration window will open after a period of time (notice the tab along the top labeled “Calibration”).

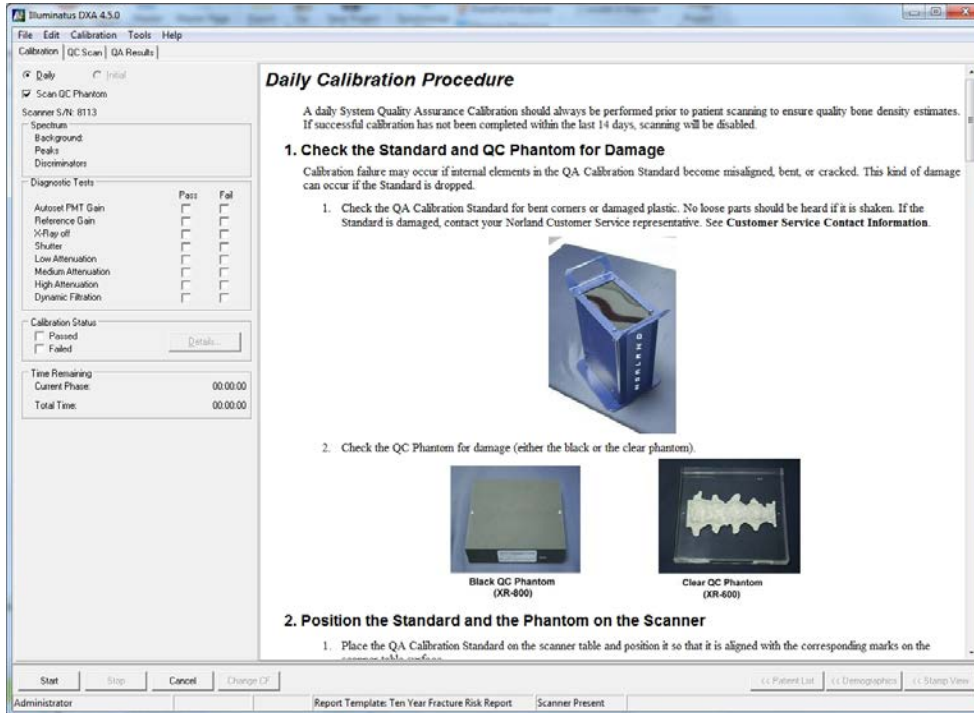
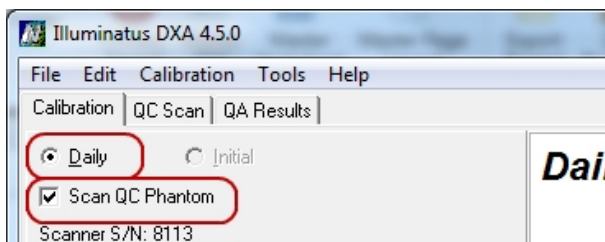



Figure 4-7: The Calibration window with “Calibration” tab selected

- b. Notice that “Daily” in the Calibration window is selected. Confirm that the “Scan QC Phantom” box is checked.



Caution: The Scanner Arm will move during the next step. STAY CLEAR OF THE SCANNER ARM.

- c. Click on  in the Calibration tab window. A dialog box will open:

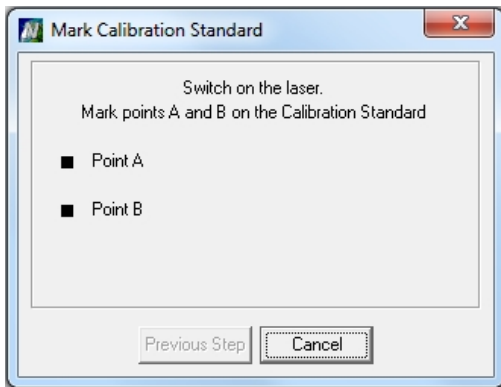



- d. Press the LASER button  on the Scanner Arm Touch Pad to switch ON the laser.

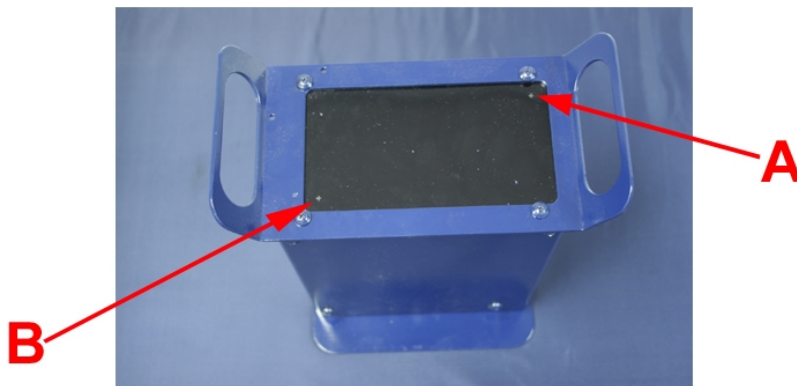

Caution: Do not stare into the beam.

- e. Use the arrow buttons to move the scanner arm so that the laser positioning dot is on the "+" on the Calibration Standard Plexiglas surface (marked "A" in the figure below).



- f. Press . The laser will blink off, then back on. The computer will emit an audible sound, signifying that the marking of point A is acknowledged.
- g. The arm will automatically move to the approximate location of point B.
- h. Use the arrow buttons to move the laser positioning dot to the "+" sign (marked "B" above).
- i. Press  to mark point B.

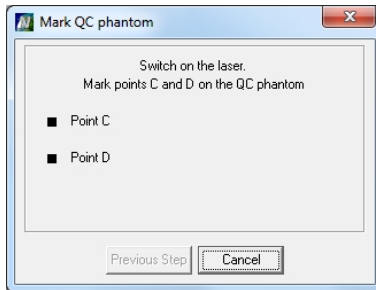

4. Calibrate Using the QC Phantom

- a. Once the Calibration Standard has been marked, the following dialog box pops up:



- b. Use the arrow buttons to move the scanner arm so that the laser positioning dot is on the dot marked C on the QC Phantom (see figure below).



- c. Press  to mark point C.
- d. The scanner will automatically move to the approximate location of point D. Move the laser to point D.
- e. Press  to mark point D.
- f. As soon as the Phantom is positioned and marked, an Alert dialog box pops up. Wait while the source ramps up. The dialog box will automatically close when the X-ray source is ready.

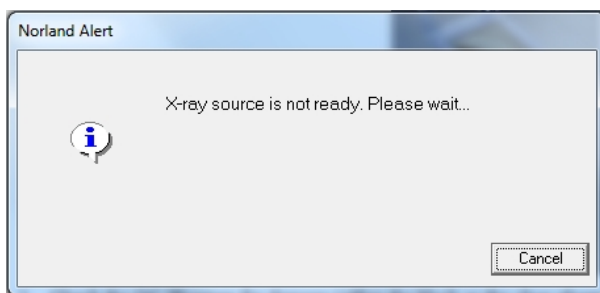

5. Automatic System Diagnostic Tests

- a. **THE CALIBRATION TAB:** The Norland software proceeds to turn the laser OFF and position the scanner arm over the Calibration Standard. A sequence of instrument diagnostic tests will be performed automatically and the results of each test will be displayed in the check mark boxes as they occur. (See the figure below.)

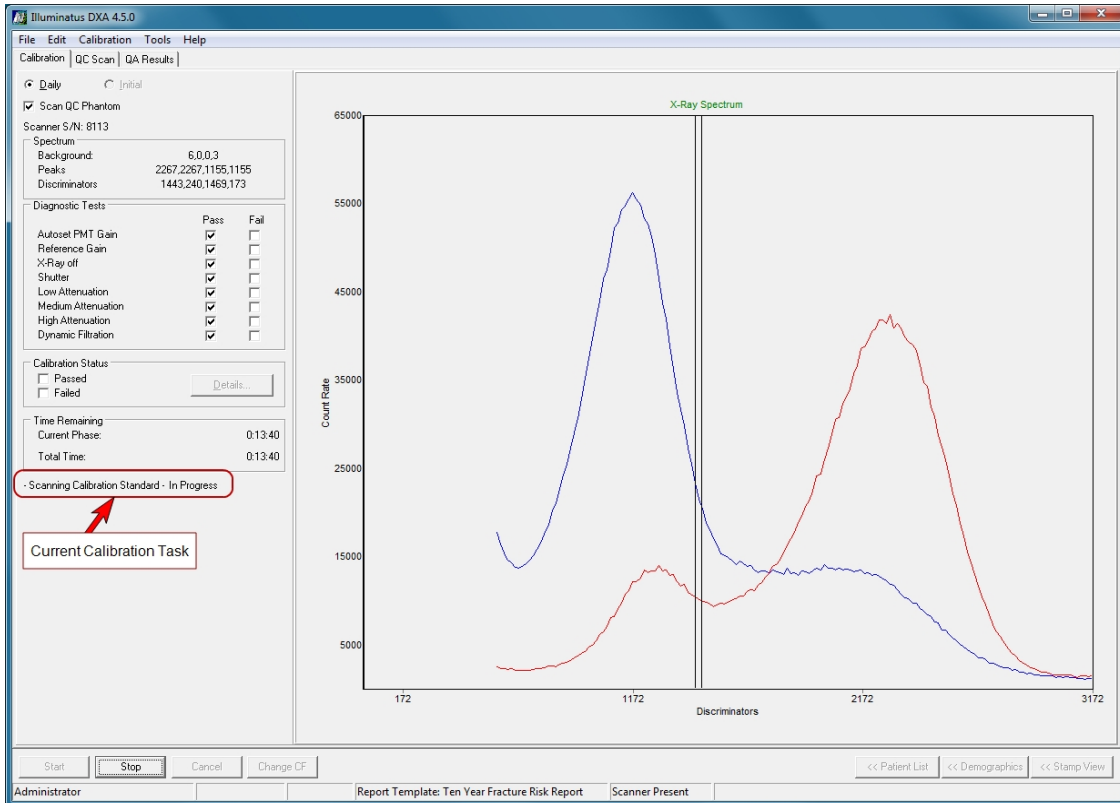

Figure 4-8: Daily Calibration in progress

- b. Notice that the current scanner tasks are displayed in the lower left hand portion of the window. They mark the phases of the calibration as they occur.
- c. The scan of the Calibration Standard proceeds automatically to completion without operator intervention and the estimated remaining time is updated periodically. Total time is about 25 minutes.
- d. **THE QC SCAN TAB:** After the Calibration Standard data is collected, the software begins doing the QC Phantom scan. The screen indicates the estimated time remaining.

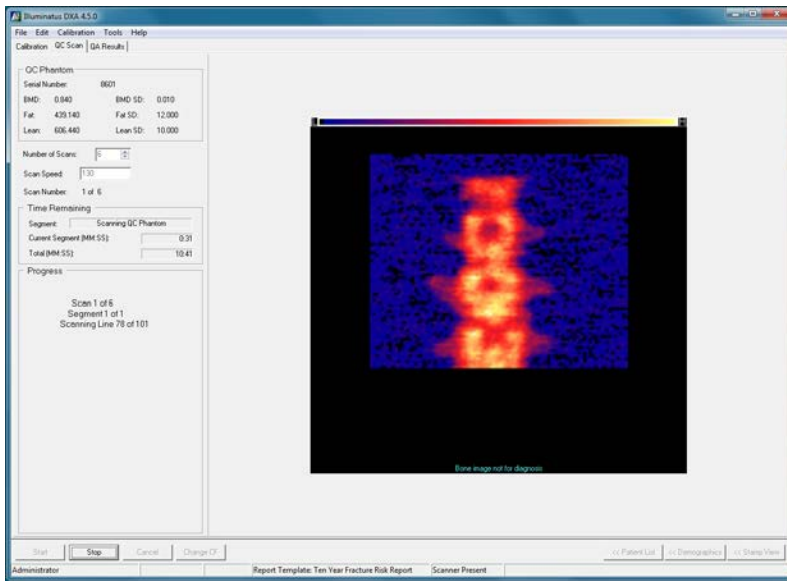

Figure 4-9: QC Scans in progress

- e. **THE QA RESULTS TAB:** The QA Results screen will be displayed at the completion of the QC Scan. The entire process takes approximately 30 minutes to complete.

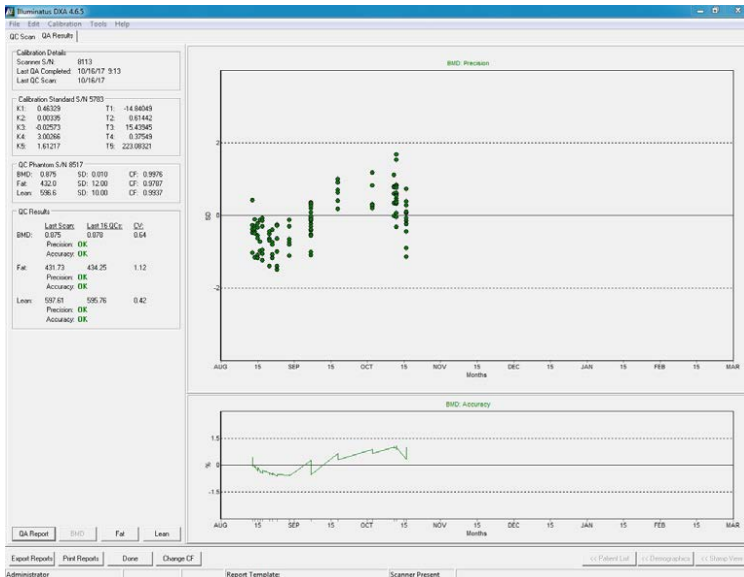

Figure 4-10: QA Results Screen

6. Verify the Calibration

BMD: Verify that the **PRECISION** and **ACCURACY** fields are labeled **OK** (see figure below).

FAT (For Soft Tissue Calibration Option Only): Verify that the **PRECISION** and **ACCURACY** fields for the Fat are labeled **OK** (see figure below). Click on to view the Fat Precision and Accuracy graphs.

LEAN (For Soft Tissue Calibration Option Only): Verify that the **PRECISION** and **ACCURACY** fields for the Lean are labeled **OK** (see figure below). Click on to view the Lean Precision and Accuracy graphs.

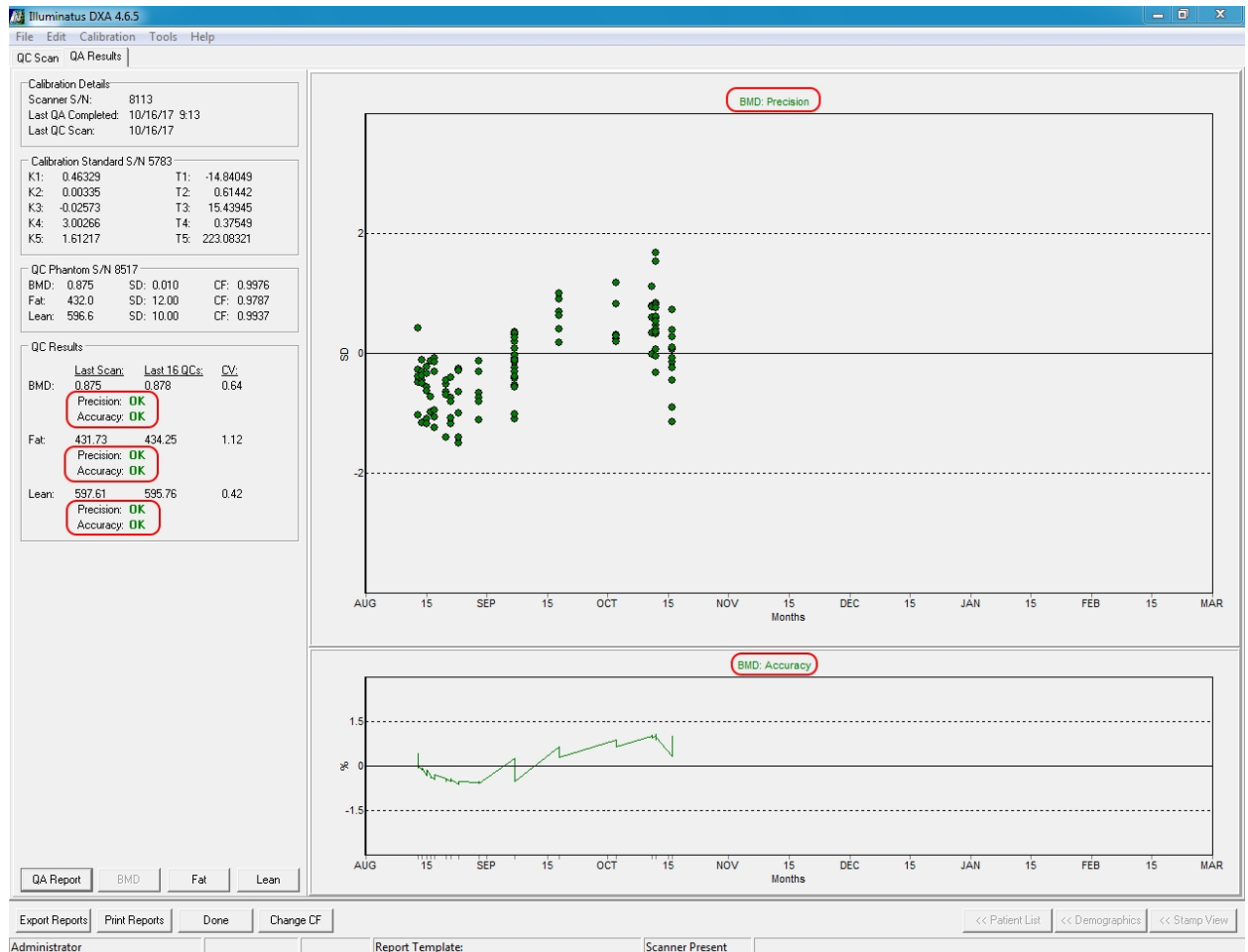

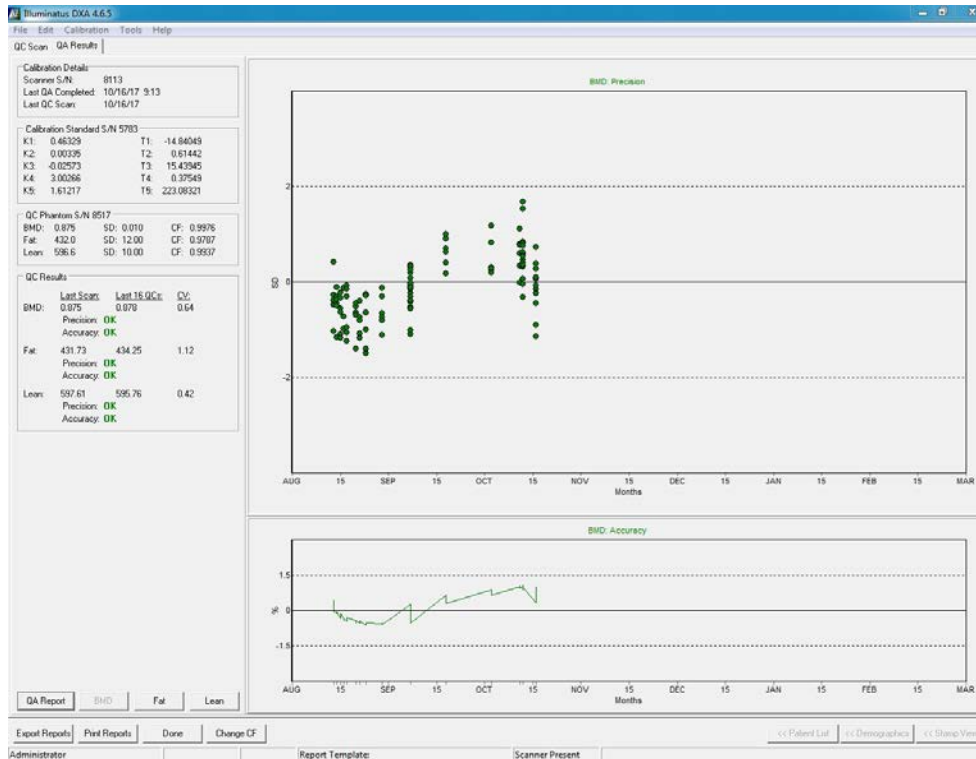

Figure 4-11: QC BMD Results



7. View and Print Calibration Results Reports

This section assumes that you have performed procedures 1-6 of the Daily System QA Calibration. In this section, you will view and print the QC Results Reports. If the QA Results window is not already open, click on **Calibration > Results** to open it. The window is copied below for reference.

(Note that a greyed out button  means that this feature is already selected and active.)





One report is generated if you scanned the clear phantom and three reports are generated if you scanned the black phantom.

An electronic copy of the report(s) can be created by exporting the report(s). Reports may be exported to either PDF or DICOM format by clicking the  button. The export type is determined by the setting in Scanner Preferences. For PDF files, browse to the appropriate directory, type in a file name and click the  button.

 **Note:** The report is not exported until the QA Results window is exited.

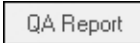
The reports may be printed by clicking the  button. To view and print individual reports:

1. **FOR A BMD REPORT:** With the **BMD** button selected, click the  button.
2. In the dialog box (below), click  to print the QA Results Report for storage in a Calibration Log paper file. A sample Report is included in this manual for reference, see "Sample Printed QA Results Report" on page 4-16.

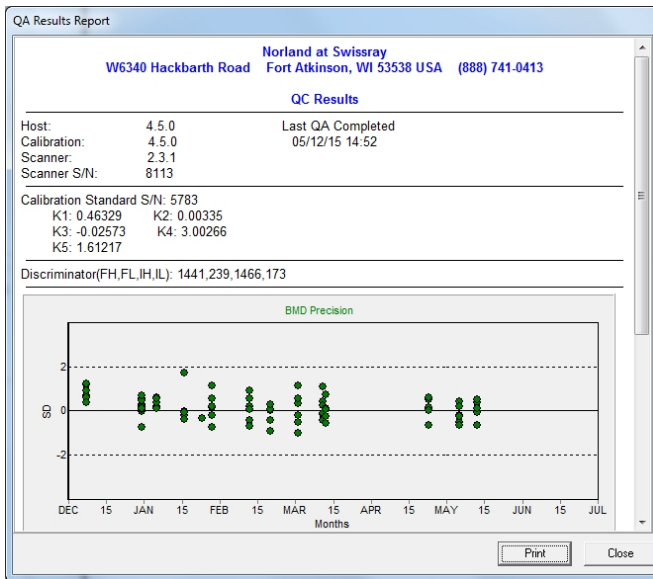

3. Click to close the dialog box.
4. **FOR A FAT REPORT:** Click to display the Fat QC results. Click . Click . Click .
5. **FOR A LEAN REPORT:** Click to display the Lean QC results. Click . Click . Click .
6. Click to close the QA Results tab window and return to the main Database Navigator window.

Sample Printed QA Results Report

Norland at Swissray W6340 Hackbarth Road Fort Atkinson, WI 53538 USA (888) 741-0413		
QC Results		
Host: 4.5.0	Last QA Completed	
Calibration: 4.5.0	05/12/15 14:52	
Scanner: 2.3.1		
Scanner S/N: 8113		
Calibration Standard S/N: 5783		
K1: 0.46329	K2: 0.00335	
K3: -0.02573	K4: 3.00266	
K5: 1.61217		
Discriminator(FH,FL,IH,IL): 1441,239,1466,173		
Phantom ID: 8601	LastQC Date: 05/12/15	Last 16 QCs
BMD: 0.840	BMD: 0.828	Mean: 0.834
BMD SD: 0.010	BMC: 49.98	CV: 0.53
PRECISION: OK		
ACCURACY: OK		

When to Repeat the Calibration

Should any part of the calibration process fail, or the precision and accuracy are not **OK**, make sure the positioning of the Standard and the Phantom is correct. Then repeat the calibration.

If the diagnostic tests fail a second time, turn OFF the power to the scanner. Turn it back on (leave the computer on). Retry the calibration.



Caution: The Scanner Arm will move when the scanner is turned on. STAY CLEAR OF THE SCANNER ARM.

If the calibration process fails the third time, contact your Norland Technical Support representative.

See "Calibration" on page 16-6 of the Troubleshooting chapter for other troubleshooting options.

To Stop the Calibration

Click

Click or .

Click to return to the **Database Navigator** window.

QA Results tab Window Interpretation

The most important parts of the QA Results window are the two text lines in the *QC Results* area labeled “Precision” and “Accuracy”. You want both lines to read “OK”. They indicate the Precision and Accuracy status of the system. In the event that the QC results statistics are *not* OK, other messages will be displayed. These messages are discussed in “QC Results Statistics Messages” on the facing page.

A typical QA Results window is shown here for reference.

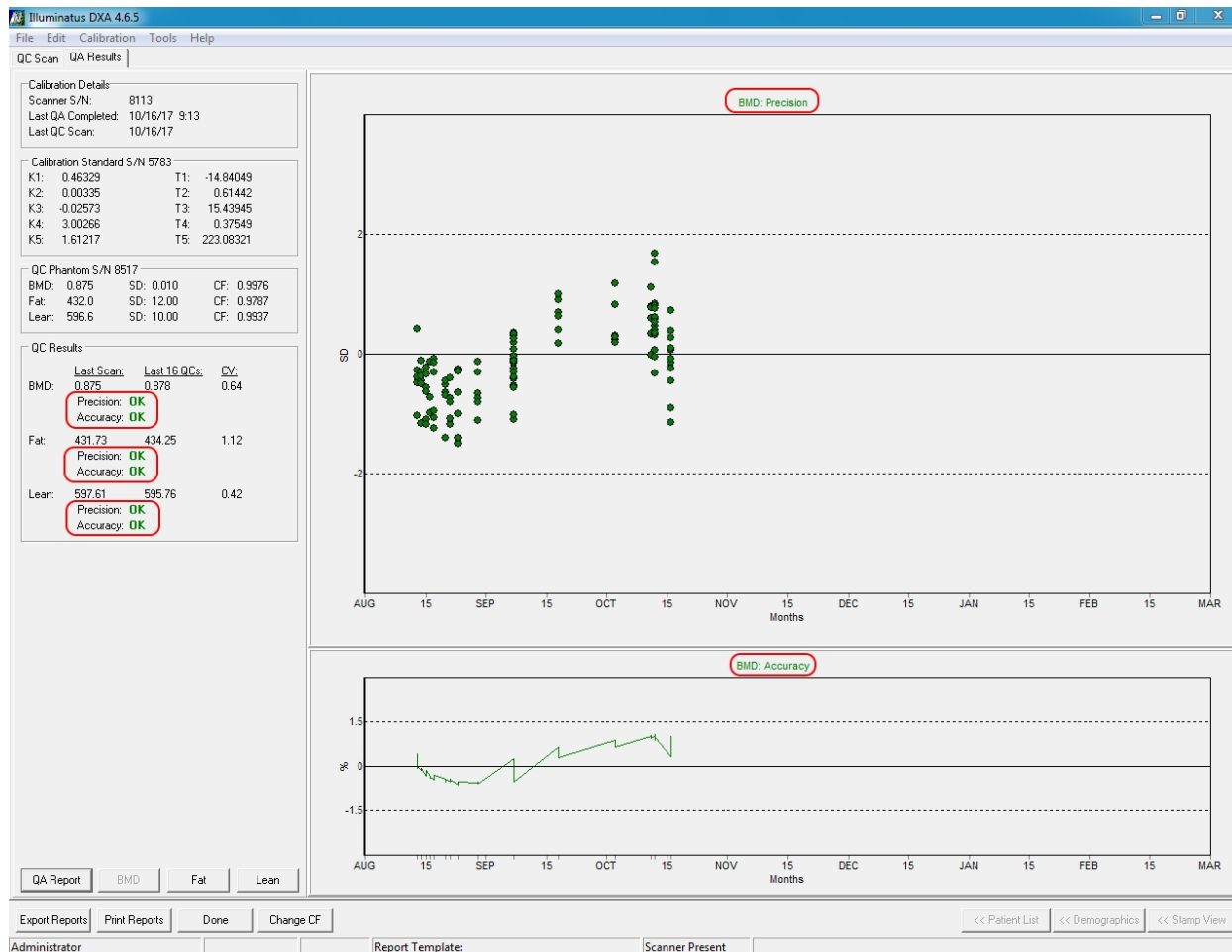

Figure 4-12: Sample QA Results tab window

An examination of the window above reveals the information grouped into four areas: *Calibration Details*, *Calibration Standard*, *QC Phantom*, and *QC Results*. The right hand side of the window contains two graphs. These are all discussed next.

CALIBRATION DETAILS AREA: contains the scanner serial number, the date of the last successful QA Calibration, and the date of the last QC phantom scan.

CALIBRATION STANDARD AREA: contains the serial number of the QA Calibration Standard used at the facility as well as its K-values and its T-values (when Soft Tissue Calibration is enabled).

QC PHANTOM AREA contains:

- » the serial number of the QC Phantom used at the facility
- » the assigned value of BMD, Fat, and Lean values used to plot the Accuracy graph (Fat and Lean only entered when Soft Tissue Calibration is enabled)
- » and the Standard Deviation of each BMD, Fat, and Lean value used to plot the Precision graph.

The assigned values were entered into the system at installation, based on factory characterization of the system's QC Phantom.

QC RESULTS AREA: shows the date of the last Calibration Scan and its resulting BMD and BMC values. If Soft Tissue Calibration is enabled (an option), the Fat and Lean results are also shown.

Below the last scan date is the numeric result of the last 16 QC's. There, the mean value and C.V. for the most recent 16 scans is displayed. If fewer than 16 scans have been performed, all calculated values are used in the computation.

Next, there are *two graphs* based on the QC Phantom scans.

UPPER GRAPH: displays the precision of the Norland system. The values from the last 180 days (6 months) of QC Phantom scans are displayed, showing their scatter about the mean. The two dashed horizontal lines indicate ± 2 S.D. about the mean. The points shown between the dotted lines are within ± 2 standard deviations. Statistically, 95% of the values obtained will fall in this range. Note that 5% of the points, or 1 out of 20, are statistically expected to lie outside the dashed lines. Points shown outside the dashed lines are those scans that exceed the ± 2 S.D.

LOWER GRAPH: displays the accuracy of the system, based on QC Phantom scans. The mean values of the last 180 days of calculations (6 months) are plotted against the assigned BMD value (or Fat, or Lean values) of the QC Phantom. The two dashed horizontal lines indicate deviations of $\pm 1.5\%$ from the BMD assigned value (or $\pm 2\%$ from the Fat and Lean values).

QC Results Statistics Messages

The tables that follow describe the possible message readouts for the Precision and Accuracy results. They are found in the *QC Results* area of the QA Results tab window (see Sample QA Results tab window).

The criteria for generating the Precision and Accuracy warning messages are modeled after those of Shewart (see Table 2 in Orwoll, et. al., J. Bone and Mineral Res. 6:1991, p.196.)

Table 4-8: QA Results tab Precision Messages and Actions

PRECISION MESSAGE	MESSAGE INDICATION	OPERATOR ACTION
OK	Precision of the system is within specification.	No Action Required
OUT OF RANGE	Standard deviation estimated from 16 scans is greater than the expected value.	Repeat QA ("Calibrate the System Using the QA Calibration Standard" on page 4-8)
WARNING 1	A single value is outside ± 3 standard deviations from the mean.	Repeat QA ("Calibrate the System Using the QA Calibration Standard" on page 4-8)
WARNING 2	Two consecutive values exceed ± 2 standard deviations from the mean.	Repeat QA ("Calibrate the System Using the QA Calibration Standard" on page 4-8)
WARNING 3	Four consecutive values of the same sign (either plus or minus), exceed one standard deviation from the mean.	Repeat QA ("Calibrate the System Using the QA Calibration Standard" on page 4-8)

Table 4-9: QA Results tab Accuracy Messages and Actions

ACCURACY MESSAGE	MESSAGE INDICATION	OPERATOR ACTION
OK	Accuracy of the system is within specification.	No Action Required
OUT OF RANGE	The Mean BMD, Fat, or Lean computed for the last 16 phantom scans exceeds $\pm 1.5\%$ of the expected value for BMD, or $\pm 2\%$ for Fat or Lean.	Repeat QA ("Calibrate the System Using the QA Calibration Standard" on page 4-8)
TREND WARNING	Eight consecutive values fall on the same side of the mean outside $\pm 1SD$.	Repeat QA ("Calibrate the System Using the QA Calibration Standard" on page 4-8)



Note: The Daily System Quality Assurance Calibration should be repeated if:

- » An **OUT OF RANGE** message is received.
- » A **WARNING 1, 2, or 3** message is received.
- » A **TREND WARNING** message is received.



Note: NOTE: Please contact your local Norland Technical Support representative if any of the following occurs:

- » **OUT OF RANGE** messages are generated on repeated calibrations.
- » **WARNING** messages are generated on repeated calibrations.
- » A **TREND WARNING** message is displayed.
- » The "QC.FIL DATES ARE OUT OF SEQUENCE" message is displayed.

Preparing Patient Records

A patient's database record must be prepared (for both new and existing patients) before a scan can be performed. Continue below to enter a *new* patient into the database. Proceed to "Locating a Record for an Existing Patient " on the next page to review and update an *existing* patient's record. For systems that have a DICOM Worklist configured, refer to "Patient Worklist" on page 13-10 for instructions on retrieving patient records from the DICOM Worklist.

Creating a New Record for a New Patient

This section discusses the procedures to create a record for a new patient. See "Patient Demographics Window Details" on page 4-25 for a thorough explanation of the buttons and fields in this window.



1. From the Database Navigator window, click the  button, or select **File > New Patient** from the menu bar. A blank Patient Demographics window will open.

Figure 4-13: A blank Demographics window for creating a new patient

2. Enter all of the patient's information in the Patient Demographics window.
 - » The <Tab> key moves the cursor down through the fields.
 - » The <Shift> <Tab> keys move the cursor up through the fields.
 - » If necessary, click  to delete the typed entries on all fields.
3. When the new patient information is complete, click  to save. If necessary, refer to Figure 4-15 "Existing Patient Demographics window " on page 4-24 to view a completed sample record.
4. Proceed to "Beginning the Patient Scan" on page 4-33 when the patient record is complete.

Locating a Record for an Existing Patient

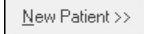
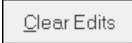
This section discusses the steps to locate and update an existing patient's record.

There are three ways to search for an *existing* patient's record in the Database Navigator window.

- A. scroll down the Patient Name column
- B. use the Quick Search field to search by Patient Name
- C. or use the Quick Search field to search by Patient ID

A: Search in the "Patient Name" Column

1. Be sure that the proper patient Database name appears in the window.
2. Scroll down the Patient Name column to locate the name.
3. Double-click on the name (or click on the name then click Demographics >>) to open the record.

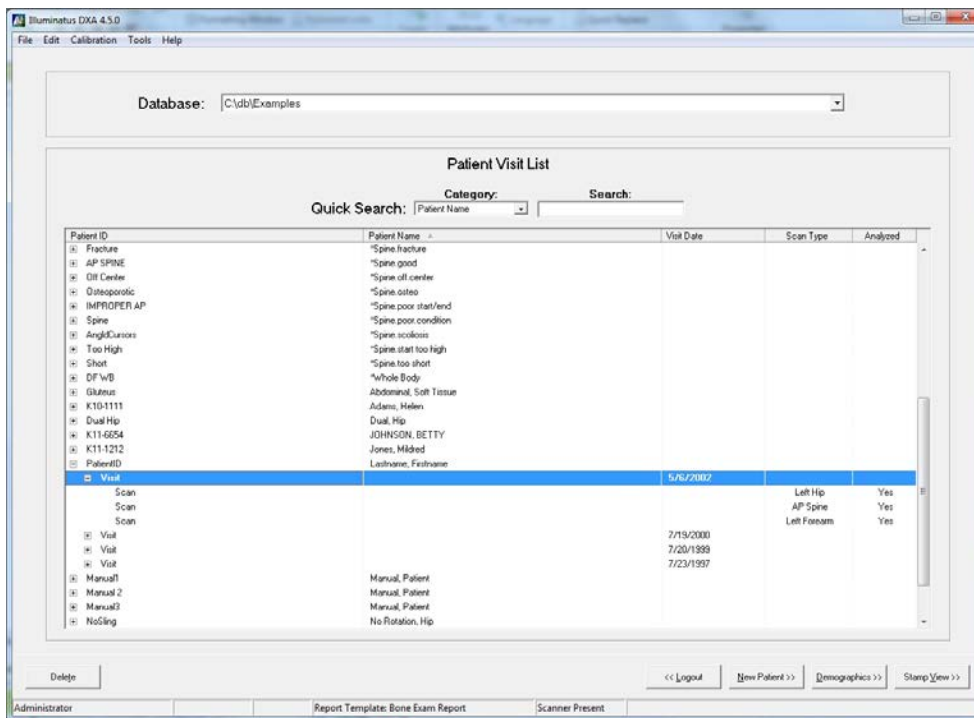

Figure 4-14: Sample Patient List in the Database Navigator window

B: "Quick Search" by Last Name

1. Be sure that the proper patient Database name appears in the window.
2. Select "Patient Name" in the Category drop-down list.

Database: C:\IlluminatusDEXA

Patient Visit List

Quick Search: Category: Patient Name Search: sm

Patient ID	Patient Name	Visit Date	Scan Type	Analyzed
12345	Smith, Sally E.			

- Begin to type the patient's last name in the Search box.



Note: The search is interactive, and will eliminate all names that do not match what you are typing. For example, type a **B**, and all patient's names that begin with a **B** appear. Typing another letter will reduce the list further. Delete all the characters to show all the names again.

- When the patient's record appears, double-click on it to open the record (or single click the name, then click [Demographics >>](#)).

C: "Quick Search" by Patient ID

- Be sure that the proper patient Database name appears in the window.
- Select "Patient ID" in the Category drop-down list.

Database: C:\IlluminatusDEXA

Patient Visit List

Quick Search: Category: Patient ID Search: 1

Patient ID	Patient Name	Visit Date	Scan Type	Analyzed
123456789	Black, Sue G.			
124356721	Blue, Gail P.			
1234	Crystal			
124356745	Green, Sally J.			
12345	Smith, Sally E.			
124356709	White, Sarah T.			

- Begin to type the Patient's ID in the Search box.



Note: The search is interactive, and will eliminate all patients whose ID do not match what you are typing. For example, type a **1**, and all patient's ID's that begin with a **1** will appear. Typing another character will reduce the list further. Delete all the characters to show all the names again.

- When the patient's record appears, double-click on it to open the record (or single click the name, then click [Demographics >>](#)).

Enter Data into the Existing Patient's Record

Now you are ready to update the patient's information. If necessary, refer to "Patient Demographics Window Details" on the facing page for a through explanation of the buttons and fields available in this window.

- When the Patient Demographics window opens, update the patient's information as necessary.
 - » The <Tab> key moves the cursor down through the fields.
 - » The <Shift> <Tab> keys move the cursor up through the fields.
 - » If necessary, click  to delete all the entries typed since the record was opened.

Figure 4-15: Existing Patient Demographics window

- When you have finished updating the patient information, **DO NOT** click  right away! Doing so will overwrite the entire patient data from the previous visits. Click the **Save** button only if you *want* to overwrite the patient history. (The current record will be saved after the scan has been completed.)

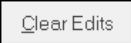
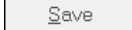
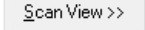

Note: Clicking on the  button, instead of the SAVE button, will create a new visit record for the current date and advance the software into the Scan View mode.

- Proceed to "Beginning the Patient Scan" on page 4-33 when the patient record is complete.

Patient Demographics Window Details

Button Functions

 - will save a *NEW* patient demographic record to the current database. On the other hand, clicking **SAVE** will overwrite the data carried in an *EXISTING* patient's record from their previous visits.

 - deletes all the entries typed since the record was opened.

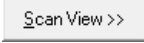

 - returns you to the main Database Navigator window (will lose all data recently typed).

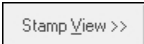
 - click when the patient record is complete and the operator is ready to perform a scan. Clicking this from the Patient Demographic window will create a new visit record for the current date.

 - click to open the Stamp View window.

Field Entry Details

- » **Last name** (*mandatory), **First Name** (*mandatory) and **MI** (middle initial, optional)
- » **Patient ID** (*mandatory) must be unique to be accepted. For example: SSN or Clinic/Hospital ID. If the ID is already in use, a message will display indicating that the value is already in use.
- » **Gender**: click the appropriate button. Male or female must be chosen in order to automatically display Reference Charts on the reports.
- » The **Ethnicity** field has a drop down list for easy selection. Click the drop-down arrow and select. An ethnicity must be entered in order to automatically display Reference Charts on the reports. If the ethnicity is not listed, click the Notepad button and type one in; however, reference graphs will not be displayed unless a matching reference data set is loaded. Refer to "How to Customize a "Drop-Down List" Field" on page 4-30.

Ethnicity  

Asian
Black
Caucasian
Cauc-Hisp
Hispanic

- » The **Date of Birth** field has the capability to call up a calendar from any year. Simply type in the birth year in a 4-digit format (ex: 1956) and click the drop-down arrow. Click the left and right arrows to move to the birth month. Click on the birth day, and the date will automatically drop into the field (and the calendar closes). The "Date of Birth" must be entered in order to automatically display Reference Charts on the reports.

Date of Birth 

February, 1968						
Sun	Mon	Tue	Wed	Thu	Fri	Sat
28	29	30	31	1	2	3
4	5	6	7	8	9	10
11	12	13	14	15	16	17
18	19	20	21	22	23	24
25	26	27	28	29	1	2
3	4	5	6	7	8	9

 Today: 5/15/2015

- » **Address, City, State, Zip and Phone** is entered next.
- » **Accession Number:** the DICOM accession number may be entered or changed. This field will only be visible if the DICOM option is enabled.
- » **Height and Weight:** enter the patient’s information. Use consistent units of measurement for the height and weight fields for every visit. Letters can be entered to designate the unit of measure (i.e. cm, ft, in, 5’2”, lbs, kg). For example:

Height: Weight:

The height and weight values will be recorded for each successive patient visit. Changing these values will not affect scan results (i.e. scan acquisition or results are not adjusted for height and weight).

- » **Billing Information:** enter the patient’s billing information. Make any necessary notes.
- » **Menopause Year:** if applicable, enter the year menopause began - in a 4-digit format (ex: 2001).

Medical History
Menopause Year

- » **Bone History:** There are 2 ways to enter information into the Bone History field.

Bone History non-traumatic bone fracture
 primary osteoporosis



- a. Click the Check button to open the Bone History Items window (shown next). Then click to select a bone history entry. Click OK to add it to the patient record.

Select Bone History Items

suspected osteoporosis

non-traumatic bone fracture

primary osteoporosis

secondary osteoporosis

bone pain

- b. Or, create a new entry by clicking on the Notepad button  to open the Bone History Item Manager window. This allows you to customize the bone history list. See "How to Customize a "Drop-Down List" Field" on page 4-30 for instructions.

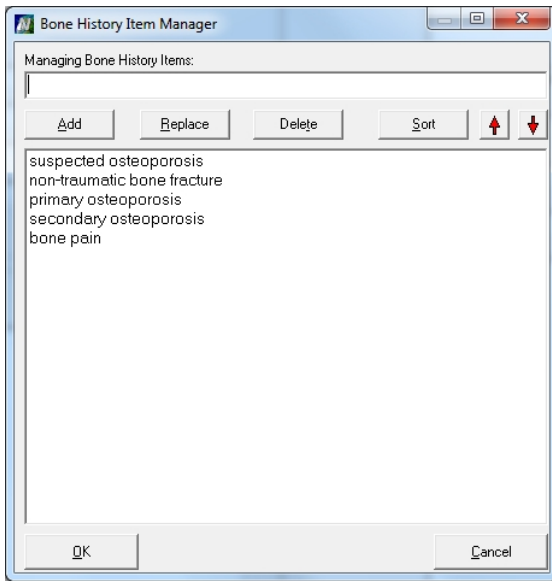

» **Treatment:** Click the cursor in the Treatment field and enter any pertinent information.

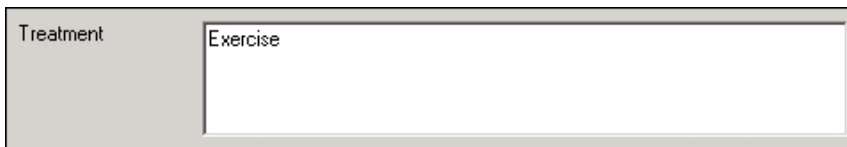

» The next four fields in the Patient's Record each contain a drop-down arrow that reveals a fully customized, operator-created list of names (the **Osteoporosis Medications**, **Technologist**, **Physician**, and **Referring Physician** fields). As an example, the Osteoporosis Medications drop-down list is reproduced here:

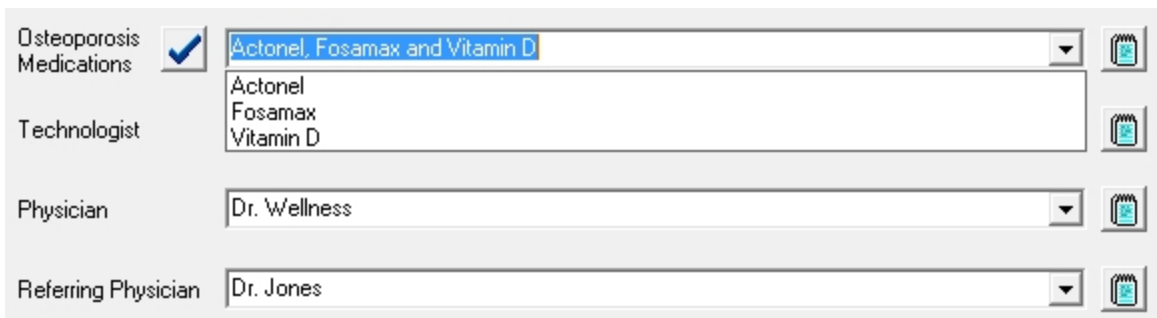

» **Osteoporosis Medications:** There are 3 ways to enter information into this field. Click the Check button, click the drop-down arrow, or click the Notepad button.

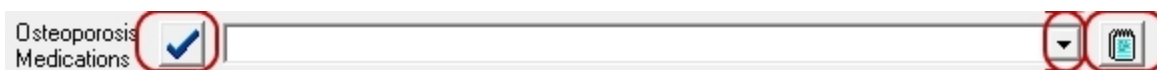

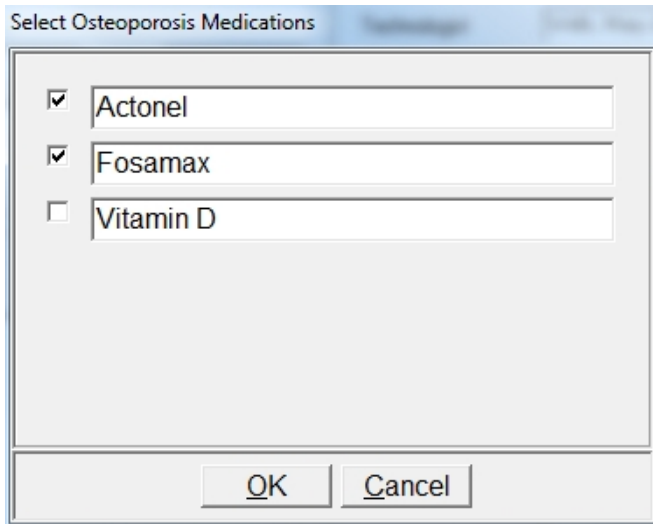

- a. Click the “check” button  to open the Osteoporosis Medications window (shown next). Click to select from the previously-created list. Click OK to add selections to the Patient Record.



b. Or, click the drop-down arrow to select a single medication name from the list.



c. Or, create a new entry by clicking on the Notepad button  to open the Osteoporosis Medications Manager dialog box. This allows you to customize the medications list. See "How to Customize a "Drop-Down List" Field" on page 4-30 for instructions.

» **Technologist:** Select a Technologist's name from the drop-down list, or create a new name by clicking the Notepad button  to enter or edit the Technologist information. See "How to Customize a "Drop-Down List" Field" on page 4-30 for instructions.



» **Physician:** Select a Physician name from the drop-down list, or create a new name by clicking the Notepad button  to enter or edit the Physician information. See "How to Customize a "Drop-Down List" Field" on page 4-30 for instructions.



» **Referring Physician:** Select a Referring Physician name from the drop-down list, or create a new name by clicking the Notepad button  to enter or edit the Referring Physician information. See "How to Customize a "Drop-Down List" Field" on page 4-30 for instructions.



» **Comments:** Enter any comments here. Be aware that these comments will print out in the Comments area of the Bone Exam Report.

Comments:	Subject shows bone denisty appropriate for age, gender and ethnic background with normal fracture risk. Subject should continue with activity and diet and consider re-evaluation in 2 to 5 years.
-----------	--

How to Customize a “Drop-Down List” Field

As previously mentioned, the Osteoporosis Medications, Technologist, Physician, and Referring Physician fields each contain a drop-down arrow that reveals a fully customized, operator-created list of names. Clicking on the Notepad button allows the user to customize the list. Full instructions follow.

Osteoporosis Medications	<input checked="" type="checkbox"/>	Actonel, Fosamax and Vitamin D	
Technologist		Actonel Fosamax Vitamin D	
Physician		Dr. Wellness	
Referring Physician		Dr. Jones	

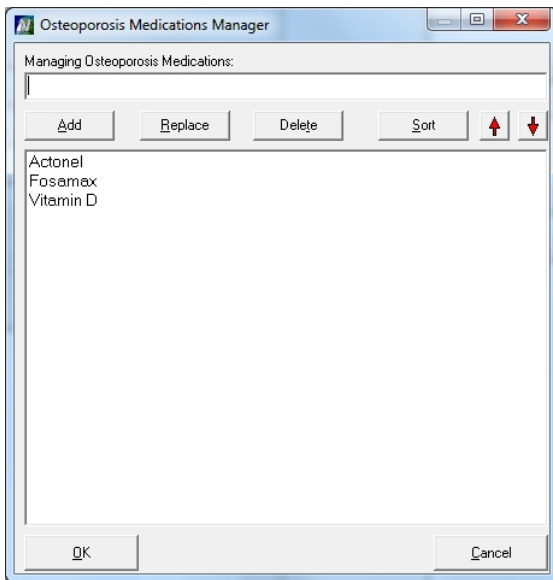

To Add a Drop-Down List Entry

1. Click on the Notepad button  to open the dialog box.

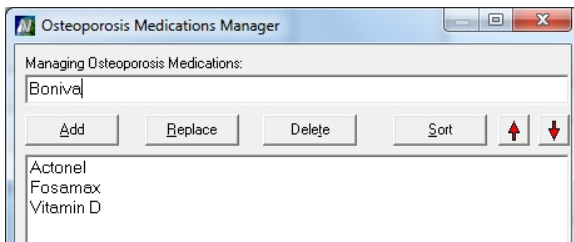

2. Enter the information in the first line of the dialog box.

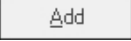



- Click . Click . (It will now be included in the drop-down list as a selection.)

To Replace (or Edit) a Drop-Down List Entry

This feature is used to replace, edit or fix a spelling error in the drop-down list.

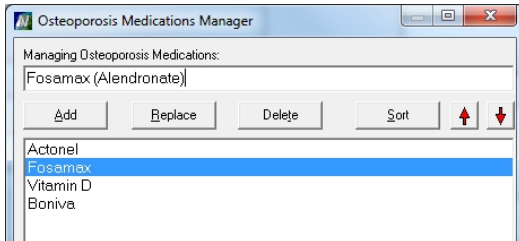
- Click on the Notepad button  to open the dialog box.
- Click on the entry to be fixed (ex. Fosamax) to copy it to the editor line.





- Type in the correction (or the replacement information) in the box (ex. added drug name).
- Click . Click . The correction will now be included in the drop-down list.

To Delete a Drop-Down List Entry

This feature is used to delete an entry from the drop-down list.

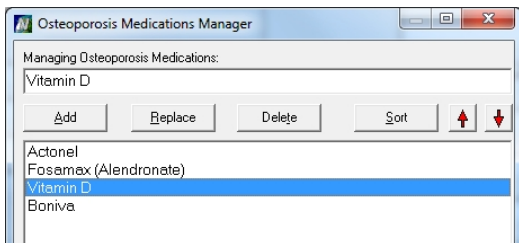
- Click on the Notepad button  to open the dialog box.
- Click on the entry to be deleted (ex. Vitamin D).



- Click , and it will disappear from the lower list.
- Click .

To Sort the Drop-Down List Alphabetically

This feature makes the entries in the drop-down list appear in alphabetical order.

- Click on the Notepad button  to open the dialog box. Notice the position of Dr. Abram's name.

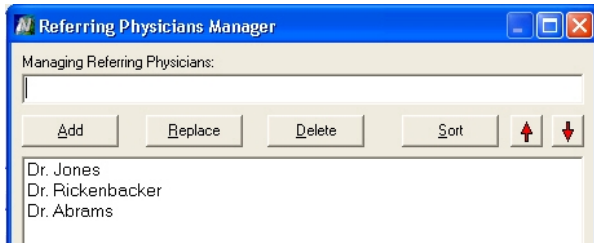

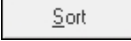

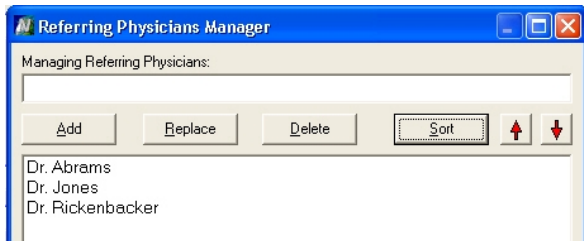

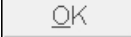
2. Click . Notice that Dr. Abram's name was sorted alphabetically and has moved to the top of the list.



3. Click  to close the box.

To Sort the Drop-Down List Manually

This feature allows the operator to place a favorite entry at the top of the drop-down list (or anywhere else).

1. Click on the Notepad button  to open the dialog box.
2. Select the entry to be moved and use the  or  arrows to move it up or down, respectively.
3. Click .

Beginning the Patient Scan

Now that the patient's record has been prepared, do the following:

Click on  to create a new visit record for the current date. (As previously mentioned, the Patient Demographics record will be saved after the scan has been completed.)

The **Select Scan Type** dialog box will open (an AP Spine Scan is used here as an example).

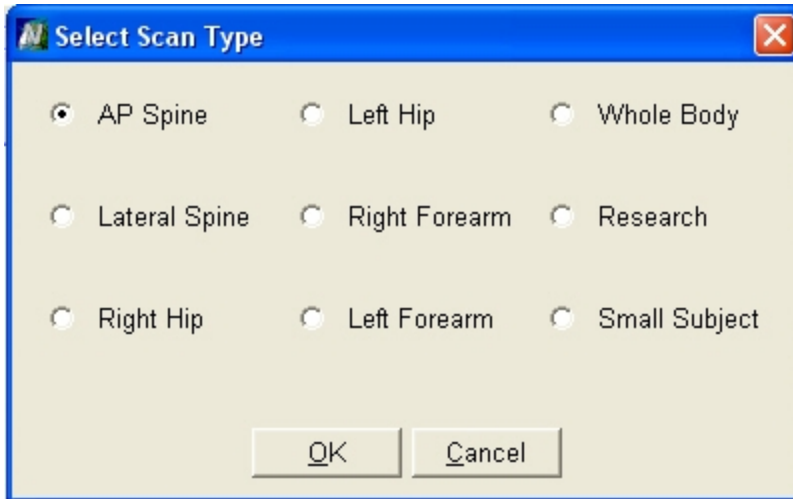

Select the type of scan, then click .

At this point, proceed to the relevant chapter listed below for instructions on positioning and marking the patient and then performing the scan. The following list provides links to those chapters.

- » **Chapter 7, Scanning AP Spine** - "Setting the Scan Parameters" on page 7-8
- » **Chapter 8, Scanning Hip** - "Setting the Scan Parameters" on page 8-8
- » **Chapter 10, Scanning Lateral Spine** - "Setting the Scan Parameters" on page 10-8
- » **Chapter 5, Scanning Whole Body** - "Setting the Scan Parameters" on page 5-7
- » **Chapter 9, Research & Small Subject Scan** - "Setting the Scan Parameters" on page 9-8



Note: Some of these scanning features are available only as options. Your system might not have some of these options.

System Shutdown



Note: Norland recommends that the scanner be left on overnight or over the weekend. If the scanner is to remain idle for a week or more, then the system should be shut off.

The system should be backed up daily, before shutting down. See the backup procedure "Quick Reference Guide - System Backup for Windows 7" on page 15-4 for instructions.

The following shut down routine will help ensure consistent system operation.

1. From the Database Navigator window, click on **File > Exit** to exit and close the Illuminatus software.
2. Confirm that the software has been closed before performing the next step.
3. Turn the scanner OFF by depressing the power switch located on the lower inside right panel.



Figure 4-16: Power Switch location

4. Shut down the computer by clicking the Windows Start button and selecting Shut Down or Turn off the Computer to perform the normal Windows shutdown procedure.
5. Turn off the monitor and the printer.

Scanning Whole Body



Note: The Whole Body Scanning feature is available as an option with the Bone Densitometer. Be aware that your system might not have this option.

The Whole Body scan option quantifies bone mineral for a subject's entire body. The analysis will present the Bone Mineral Content (BMC) in grams, Bone Mineral Density (BMD) in g/cm², and AREA in cm², for the total body as well as the head, trunk, abdomen, arms, legs, and operator-defined regions of interest.

The Whole Body scan requires the operator to mark the start and baseline points. Intelligent scanning (i.e. scanning body edge to body edge) is used to minimize scan time and to ensure the scan automatically stops after scanning the patient's feet.



Figure 5-1: Patient Positioning for the Whole Body Scan

This chapter discusses the following.

Scan Specifications	5-2
Maintaining High Quality Whole Body Scans	5-3
General Patient Scanning Cautions	5-4
Quick Reference - Whole Body Scan	5-5
Scan Procedures	5-6
Analyzing the Scan	5-15
Viewing the Scan Results Tab	5-18
Generate and Print a Report	5-20
A Sample Bone Exam Report	5-22

Scan Specifications

Detailed specifications for the Whole Body scan are in the following tables.

Table 5-1: Whole Body Scan Specifications

Scan Site	Entire Body
Accuracy ^a	Typically within 2.0% of industry standard
In vivo Precision ^b	See table below

Table 5-2: Whole Body Scan In vivo Precision - Scanners with Dynamic Filtration

Resolution, Scan Speed		Head	Trunk	Abdomen	Arms	Legs	Total
6.5 x 13.0mm 260mm/sec	BMC C.V.	1.5%	1.2%	2.3%	1.8%	1.1%	0.67%
	BMD C.V.	1.6%	2.1%	2.3%	1.6%	1.3%	0.78%
	AREA C.V.	1.2%	1.4%	2%	1.6%	1.0%	0.66%
*** All specifications are subject to change without notice. ***							

Patient Dose



Note: The radiation dose to the patient is dependent on the resolution, filtration, the scan speed used, and the system configuration. Dose values listed below are for any patient thickness.

Table 5-3: Whole Body Scan Skin Entrance Dose

Resolution	Scan Speed	Patient Dose (μSv)
6.5 x 13.0mm	260mm/sec	0.2
	130mm/sec	0.4
4.5 x 9.0mm	260mm/sec	0.3
	130mm/sec	0.5
2.8 x 7.8mm	200mm/sec	0.5
	100mm/sec	0.9

Operator Dose



Note: The dose to the operator is negligible. During a scan, the radiation level at a distance of one meter from the scanner table is less than 1.0 microsieverts per hour.

^aBased on Standard Speed Scans of an anthropomorphic phantom.

^bBased upon 14 subjects, 3 scans each, using standard procedures.

Maintaining High Quality Whole Body Scans

Patient positioning, scan and analysis techniques can influence the precision and accuracy of Bone Density estimations. Facilities can reduce the adverse effects of some of these factors by:

- » Performing and monitoring the daily QA procedure to verify that other radiation sources (X-ray machines, nuclear imagers) are not affecting the performance of the Norland system. The daily QA procedure verifies proper operation as well.
- » Ensuring that all operators position patients and analyze data in the same manner.
- » Screening patients for recent radionuclide uptake procedures. Residual emission may be misinterpreted by Norland Bone Densitometers as x-rays.
- » Screening patients for recent ingestion of radiopaque substances. Barium or other dyes used in some x-ray procedures could result in increased soft tissue x-ray absorption.
- » Screening patients for prosthetic devices, implants, surgical staples, or other high density sub-dermal materials that may affect density estimates.
- » Ensuring that scan and analysis parameters remain constant for all scans of the same patient.
- » Ensuring all jewelry, eye glasses, belts, and other high density objects are removed from the patient.
- » Ensuring all body parts are within the scan area.
- » Advise the patient to breath normally and do not move during the scan.

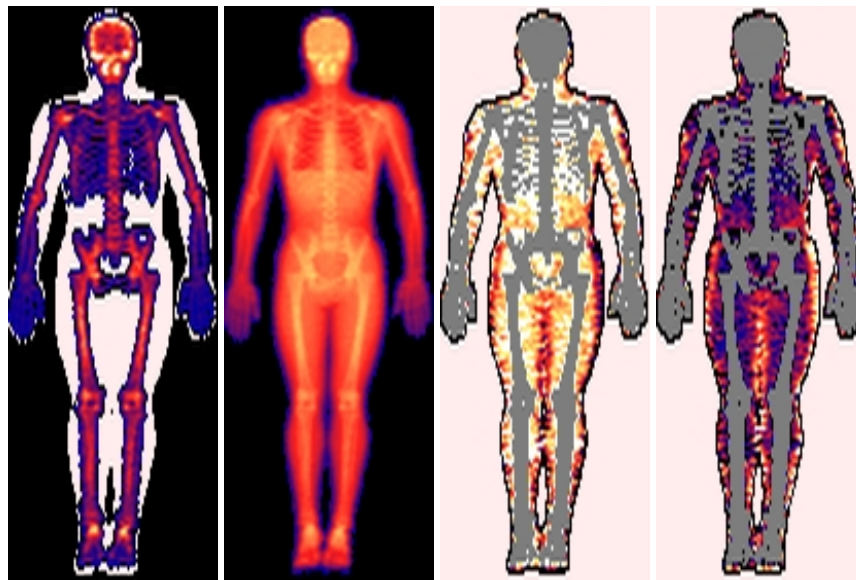

Figure 5-2: Example of a Good Quality Whole Body Scan (Bone, Composite, % Lean, and % Fat images)

General Patient Scanning Cautions



Caution: Properly Mark the Patient. To ensure scanner arm does not contact the patient, always verify patient is positioned properly before scanning or moving the scanner arm.



Caution: Do not move the patient while marking the regions to be scanned. Always remain near the patient, in the event assistance is needed.



Caution: Do not touch the patient and the computer system at the same time as this could increase leakage currents.



Caution: Do not reach around to the back of the unit while the scanner arm is moving. While guards are provided, it is wise to avoid any chance of pinching the arm, hand, or fingers between the scanner arm and the frame, or between the source and the scanner arm.



Caution: Do not allow the patient to bump, push, or lean on the scanner arm. Manually moving the arm could result in an error message which will require removing the patient from the table and doing the Find Table Dimensions routine.



Caution: Make certain the patient does not dangle their arm or hand over the riser while the scanner arm is moving during a scan. The scan will not be usable, as the patient will not be properly positioned, and the patient may be at risk of pinching their hand or finger between the scanner arm and the riser or between the x-ray source and the scanner arm.



Caution: Make certain the patient does not stick a finger into the slot in the bottom of the upper arm cover during a scan; it could be pinched.



Caution: When positioning the patient, ensure they start by sitting near the center of the table and then swing their legs up. Sitting at either end makes positioning awkward.



Caution: Caution the patient to remain still during the scan to ensure quality results.



Caution: Help the patient up from the scanner after scan data collection; some patients may require a few minutes to regain equilibrium after lying down for a length of time.

Quick Reference - Whole Body Scan

The Whole Body scan procedures take measurements from the entire body and present BMC, BMD and Area for the total body as well as the head, trunk, abdomen, arms, and legs.

- » Screen patient for contraindications.
- » In the Database Navigator window, click on the *existing* patient's name, then click OR click to start a *new* record.
- » Update (or enter) the patient's Demographic information.
- » Click . Click the Whole Body button. Click . Check the parameters.
- » Have the patient lie on the table, face up with the head oriented to the right side of the table, (operator facing the table).



Caution: Caution the patient not to stare into the beam.

- » Click in the Parameters tab window.
- » MARKING THE START POINT: Turn ON the laser. Position the laser dot 1-cm above the top of the center of the patient's head, and press the button on the Scanner Arm Touch Pad.
- » MARKING THE END POINT: Move the scanner arm over the patients abdomen. Turn ON the laser. Position the laser dot at a point on the abdomen adjacent to the spine and midway between the lowest rib and the iliac crest. Mark in an area of maximum soft tissue and no bone. Press the button.
- » Click to begin the Measure Scan.
- » If the scan is satisfactory, click .
- » If you are done scanning, assist the patient up from the table.
- » Position the top edge of the chest cursor to just under the chin. Position the upper control points above the junctions of the humerus and scapula. Position the bottom control points to include the rib cage.
- » Position the pelvic cursor to encompass the pelvis, yet containing a minimum of midriff, leg, and femoral neck tissue.
- » Position the leg cursors so that both legs are encompassed.
- » Once the cursors are positioned, click .
- » Click .
- » Click .
- » Click to print a Report (or click to end the process and return to the main window).
- » Click and then .

Scan Procedures

Checklist

You are almost ready to begin scanning. Confirm that the following tasks have been completed:

- » the system is running (see "Powering Up the System " on page 4-3)
- » the System Calibrations are done (see "Daily Calibration Procedure" on page 4-6)
- » the Database Navigator window is open (Figure 4-3: on page 4-5)

Preparing the Patient for Scanning

Ensure that the patient has removed all items from their pockets and that clothing is free of metal (i.e. rivets, buttons, zippers) or anything else that might be of a high density. It might be necessary to have the patient change to an examination gown or robe. Shoes should also be removed.



Caution: Do not scan patients that may be pregnant or have had a recent radionuclide uptake procedure.

Update (or Create) the Patient's Record

EXISTING PATIENT: From the Database Navigator window, double-click on the existing patient's name to open the patient's record. Update the patient's information. (If necessary, refer to "Enter Data into the Existing Patient's Record" on page 4-24 for instructions.)

You are now ready to begin the scan process.

Proceed with "Setting the Scan Parameters" on page 7-8 to continue.

NEW PATIENT: From the Database Navigator window, click on  to start a new record. Enter all the patient information. (If necessary, refer to "Preparing Patient Records" on page 4-21 for instructions.)

You are now ready to begin the scan process.

Proceed with "Setting the Scan Parameters" on page 7-8 to continue.

Setting the Scan Parameters

1. Click **Scan View >>**.
2. Click **Whole Body** in the pop-up window.

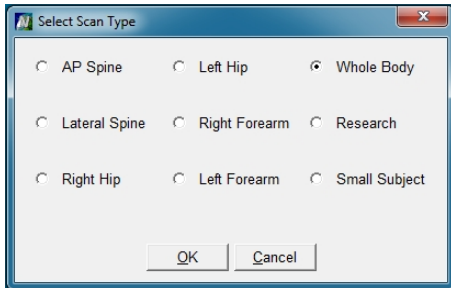

3. Click **OK**.
4. The **Parameters** tab window opens.

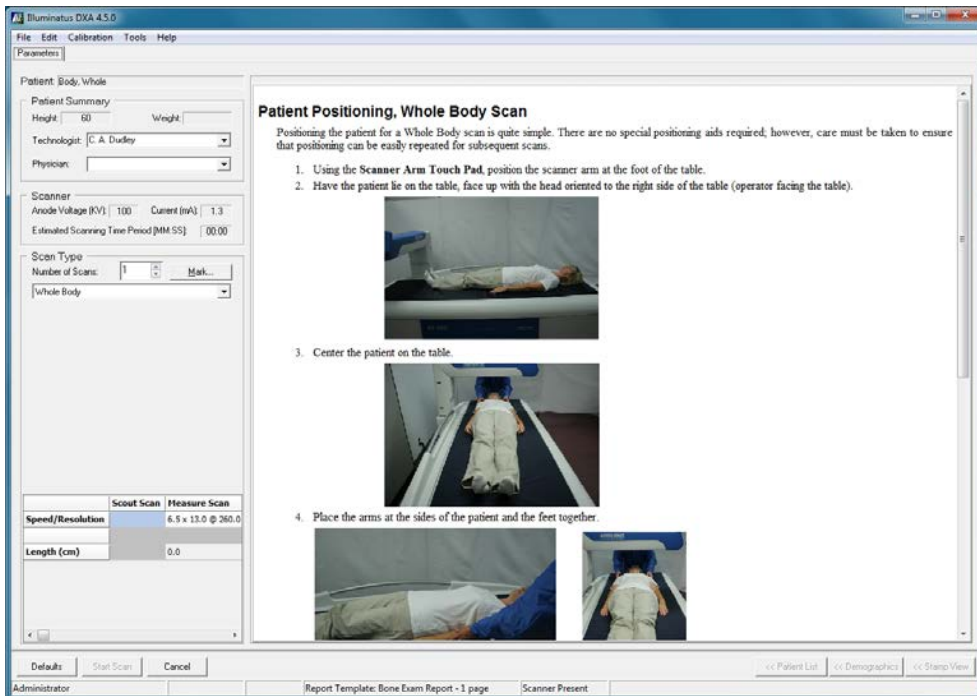

Figure 5-3: The Whole Body Scan Parameters tab window

5. The scan parameters are shown in the bottom left hand side of the Parameters tab window, and reproduced here for reference. Norland recommends that the factory default parameter settings be used for scanning. The default values are shown below.

	Measure Scan
Speed/Resolution	6.5 X 13.0 @ 260 ▾
	6.5 X 13.0 @ 260
Length (cm)	6.5 X 13.0 @ 130
	4.5 X 9.0 @ 260
	4.5 X 9.0 @ 130
	2.8 X 7.8 @ 200
	2.8 X 7.8 @ 100

- » To reset values to factory defaults, see "Preferences: Whole Body Scan" on page 3-27.
 - » For a full explanation of the Whole Body Scan parameters (i.e. preferences) see "Preferences: Whole Body Scan" on page 3-27.
 - » If it is necessary to change the *Speed/Resolution* parameter, see "Changing the Scan Parameters Prior to Scanning" on page 11-75.
6. Proceed to "Positioning the Patient" on the facing page to continue.

Positioning the Patient

Positioning the patient for a Whole Body scan is quite simple. There are no special positioning aids required, however, care must be taken to ensure that positioning can be easily repeated for subsequent scans.

Refer to the patient positioning photos and instructions in the Norland software (Parameters tab window). The steps and photos are reprinted in the manual for reference.

1. Using the Scanner Arm Touch Pad, position the scanner arm at the foot of the table.
2. Have the patient lie on the table, face up with the head oriented to the right side of the table, (operator facing the table).



3. Center the patient on the table.

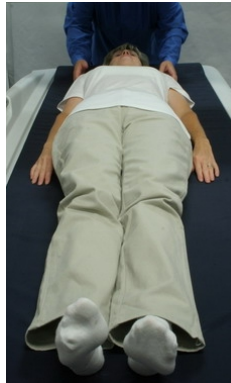

4. Place the arms at the sides of the patient and the feet together.



- Use velcro straps, tape, or a sheet to secure the hands and feet so that patient movement is kept to a minimum.



Caution: Caution the patient not to stare into the beam.



- Turn ON the laser by pressing .
- Move the scanner arm around the perimeter of the table, using the laser positioning dot to make sure that the patient is within the scan window.





- The patient is now ready for scanning.
- Make the patient as comfortable as possible since movement during the scan will affect the results. The use of a sheet or light blanket will not interfere with scan results. Do not use a pillow under the patient's head.

Marking the Scan Region

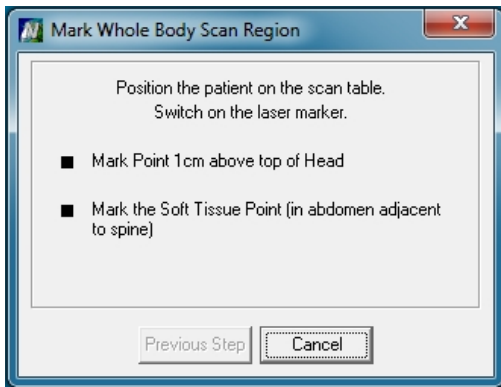

- Click in the Parameters tab window to open the dialog box.



2.  Ensure that the laser is OFF, move the scanner arm above the patient's head.

 **Caution:** Caution the patient not to stare into the beam.



3. Press  to turn the laser ON.
4. **MARKING THE START POINT:** move the scanner arm until the laser positioning dot is approximately 1-cm above the top of the center of the patient's head and press . (The computer will emit a sound, and the laser will turn OFF.)



 **Note:** Click  in the dialog box to re-mark the start point. Click  at any time to abort the marking operation.

5. **MARKING THE SOFT TISSUE POINT:** move the scanner arm over the patient's abdomen.



6. Press  to turn the laser ON.

7. Position the scanner arm so that the laser positioning dot is at a point on the abdomen adjacent to the spine and midway between the lowest rib and the iliac crest (see figure below). This is the area of maximum soft

tissue thickness. Press the  button.



8. The computer will emit a sound, and the laser will shut OFF.
9. The dialog box will automatically close when the marking tasks are complete.

Starting the Measure Scan

Caution the patient to remain still.



Remember, press the Emergency Stop button directly below the Scanner Arm Touch Pad to immediately terminate the x-ray exposure or stop the scanner arm movement. Refer to "Pressing the Emergency Stop Button" on page 11-37 for instructions on safely resuming the scan.

1. Click .
2. The Scan tab window displays the image as it develops, shows how many lines will be scanned and gives an estimate of the total time remaining in the Measure scan.

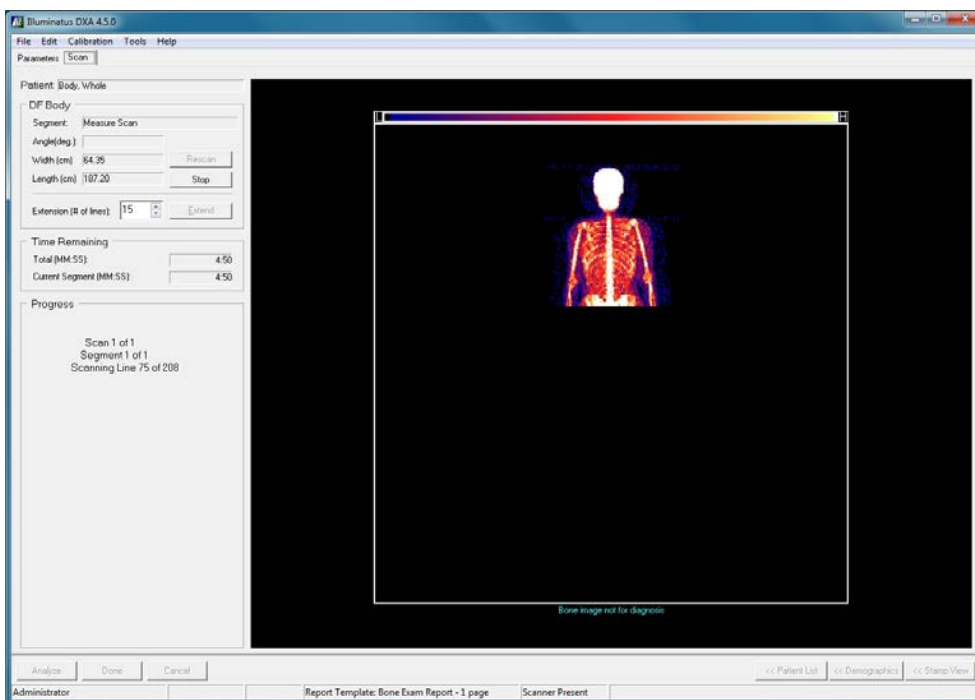

3. Monitor the image closely for any indication of patient movement. Cancel the scan immediately if the patient moves during the scan.



Note: To cancel the scan: Click .

Click . Select in the dialog box. Click .

Click . Click . Select Whole Body.

Return to "Marking the Scan Region" on page 5-10 to continue.

4. When the Measure Scan is complete, the computer will emit a sound. The software will update the Scan tab window and the *Analyze* button will become available.

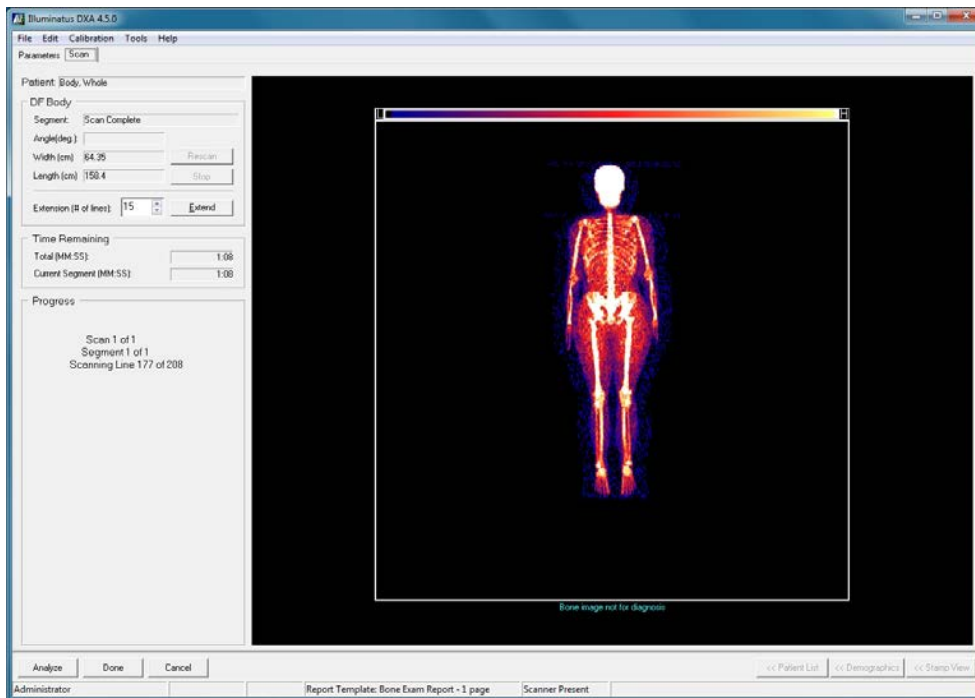

5. Determine if the quality of the Measure Scan image is satisfactory or unsatisfactory.
6. **IF THE IMAGE QUALITY IS SATISFACTORY**, and no evidence of patient movement during the scan is exhibited, proceed to Step 8.
7. **IF THE IMAGE QUALITY IS UNSATISFACTORY**, do one of the following:
- » Enter the appropriate number of scan lines in "Extension (# of lines)" and click to include the entire region of interest.
 - » OR click and remark the scan region (see "Marking the Scan Region" on page 5-10).
8. If no further scans are to be performed, help the patient up from the scanner table. Make sure the scanner arm will not impede the patient's ability to sit up.



Caution: Remember that some patients may require a few minutes to regain equilibrium after lying down for a length of time.

Analyzing the Scan

At this point, the operator can analyze the scan later, or analyze the scan now.

ANALYZE LATER: Click to end the scan process and analyze the scan later. The scan data will be saved to the database for analysis at a later time. The software will go back to the Parameter tab window. You can do another type of scan, if desired.

OR ANALYZE NOW . . .

1. Click .
2. When the **Analysis** tab window opens, cursors will be displayed in the regions of interest: the chest, pelvic area, and each leg.

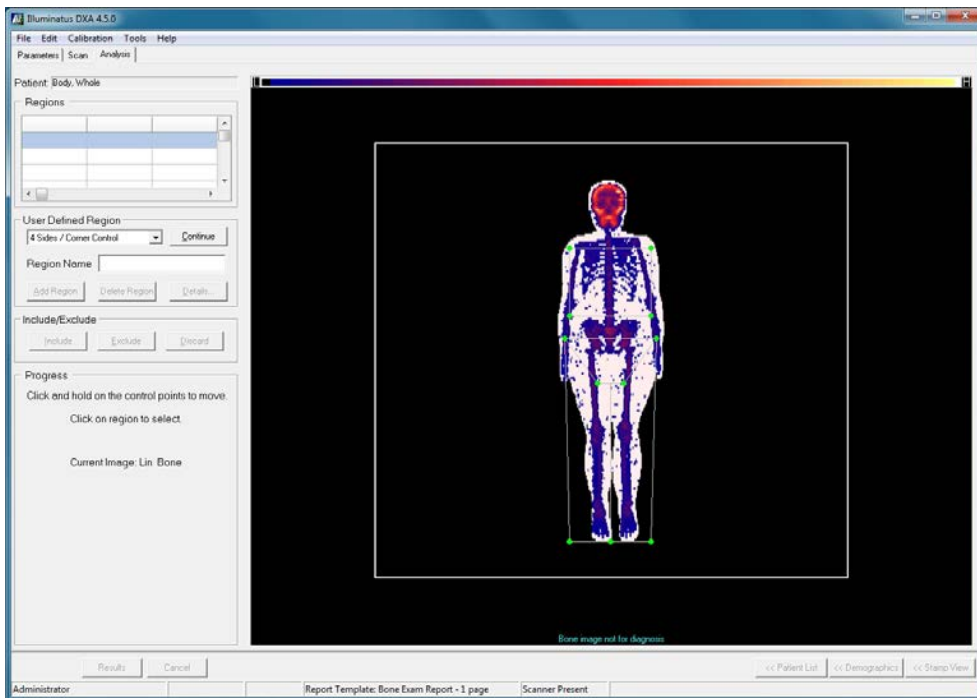

Note: If this scan is not the initial scan, use the Show Comparison function to aid in matching the cursor positioning. See "Comparison Image" on page 11-54.

3. Click and drag to position the chest cursor in the middle of the chest. Position the upper cursor points above the junctions of the left and right humerus and scapula. Position the bottom cursor points between the arms and torso, with the bottom edge barely enclosing the rib cage.

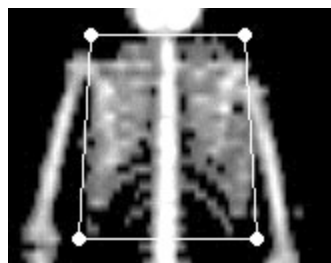

4. Position the pelvic cursor next. Move the upper control points to just above the iliac crests, between the arm and torso. Position the bottom left pelvic cursor so that the left cursor edge passes through the femoral neck and is close to the pelvis, and the bottom edge of the pelvic cursor is just below the pubic symphysis. Position the bottom right cursor similarly on the opposite side. Make sure the trapezoid is set to enclose the pelvis.
5. If positioned correctly, the pelvic cursor will completely surround the pelvis and contain a minimum of midriff, leg, and femoral neck tissue.

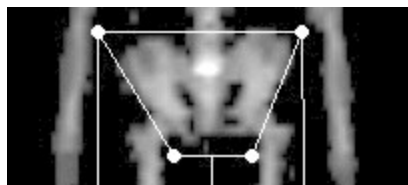

6. Position the lower left leg cursor so that the left leg cursor edge lies along the region of minimum body tissue between the left thigh and the left hand. The bottom edge should be below the toes. Position the right leg control points similarly. Position the center leg cursor so that the center leg cursor edge lies along the region of minimum body tissue between the left and right leg.

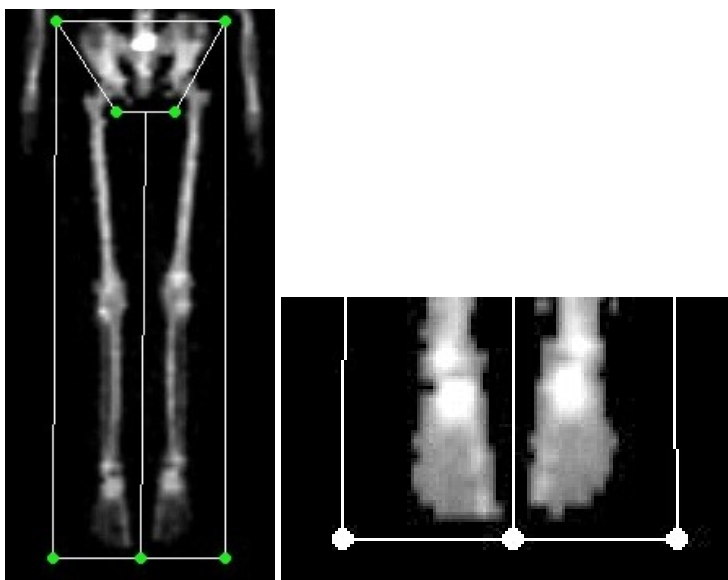

The regions of interest are defined graphically in Figure 5-4.

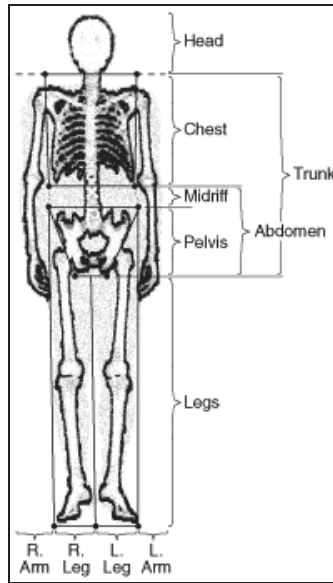
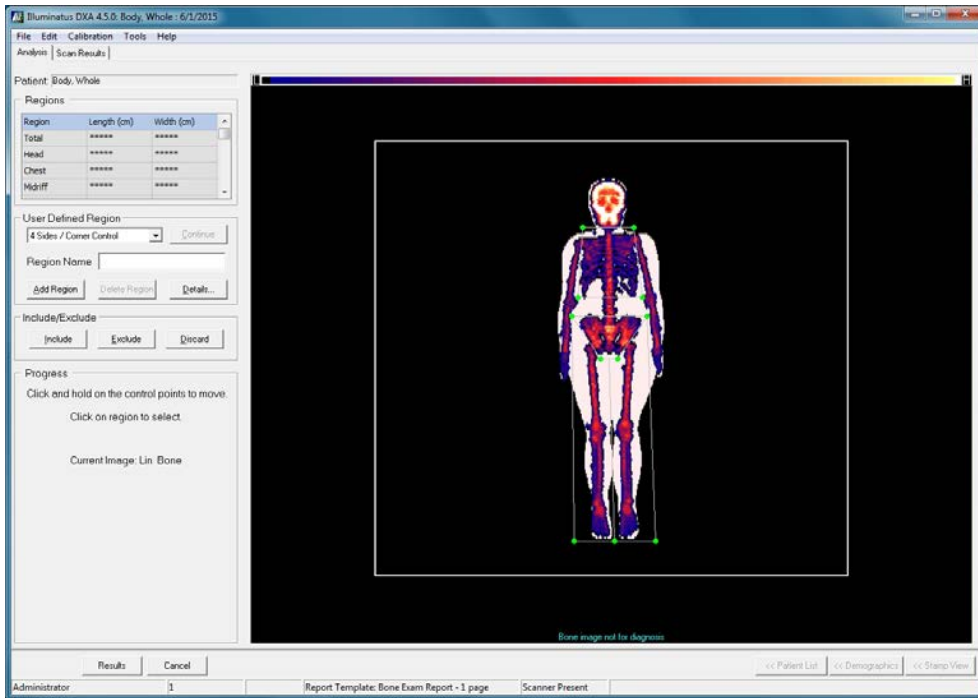

Figure 5-4: Regions of Interest, Whole Body Scan

7. Click . The Results button will become available.



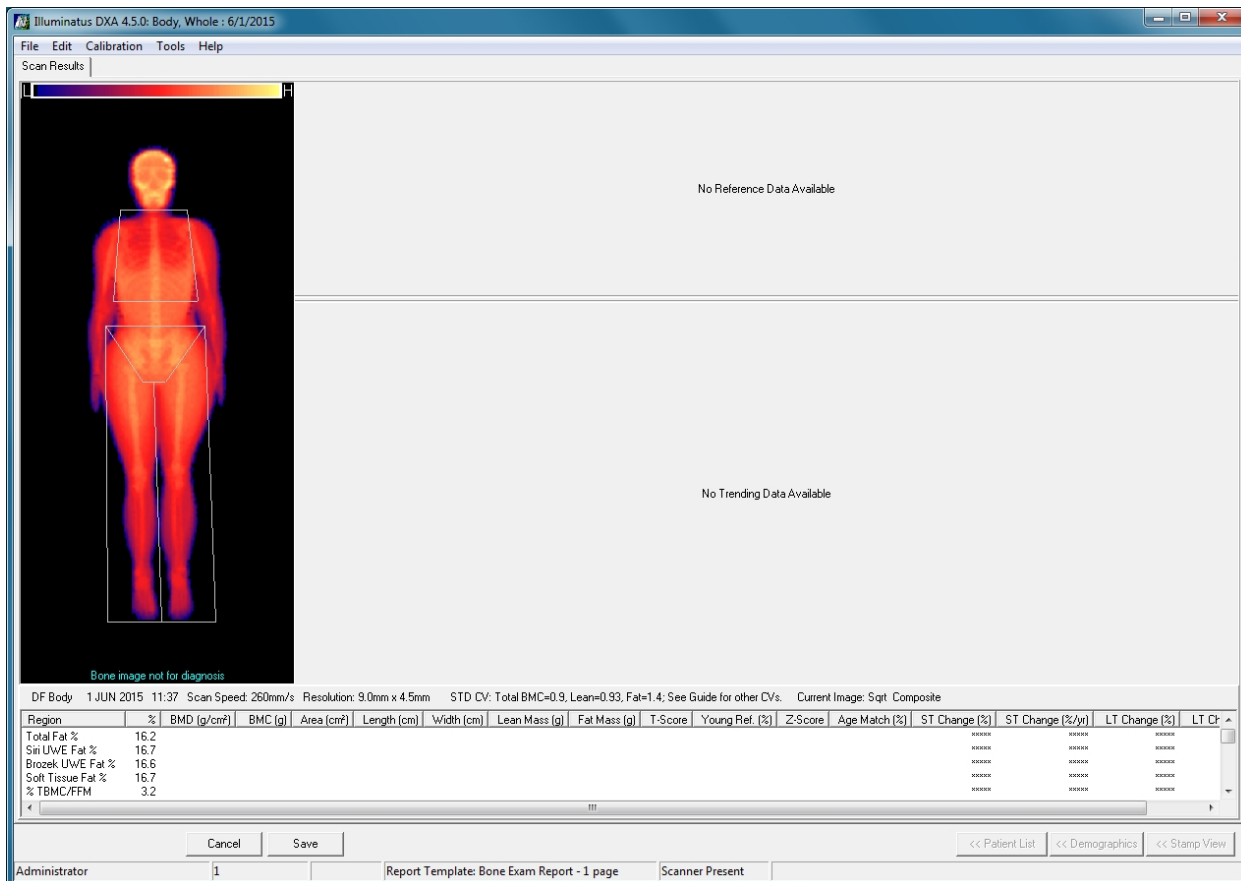

Viewing the Scan Results Tab

1. Click . The Scan Results tab window opens.
2. View the image to ensure that cursors are positioned correctly and analysis results are satisfactory.
3. The scan image, trending graphs, results for Total Body will be displayed in the Results tab. The *Total BMD* (in g/cm²) and the *Total BMC* (in grams) will be displayed below the trending graph.
4. The *BMD*, *BMC*, and *AREA* (in cm²) for Total and each region of interest analyzed will also be displayed.
5. If Soft Tissue Composition is enabled, the Whole Body regions *Total Fat %*, *Siri UWE Fat %*, *Brozek UWE Fat %*, *Soft Tissue Fat %*, and *% TBMC/FFM* will also be displayed for the Total region. Lean Mass and Fat Mass will be displayed for all regions of interest. (Be aware your system may not have the Soft Tissue Composition option.)

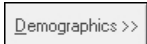

6. Click to save the Scan Results.
- » Click to generate and print a report using the current default report template. Proceed to Step 5 of "Generate and Print a Report" on page 5-20.
- » or click to generate and print a report using a report template other than the default. Proceed to "Generate and Print a Report" on page 5-20.

- » or click  to do another scan.
- » or click  to end the process and return to the main window.

Generate and Print a Report

Seven different types of Reports can be generated for each scan: the *Body Composition Report*, the *Body Composition Report - 1 Page*, the *Bone Exam Report*, the *Bone Exam Report - 1 Page*, the *Combined Report*, the *Patient Letter*, and the *Referral Letter*. When saved, these reports become part of the scan data.

These procedures use the *Bone Exam Report - 1 Page* for the example.

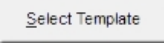
1. Make sure that the scanned image is being viewed as a thumbnail in the **Stamp View** or the **Filmstrip View**. Click (to highlight) the thumbnail view of the scan.
2. Click **Tools > Report > Select Template...** or click the  button to open the "Report Configuration" dialog box.

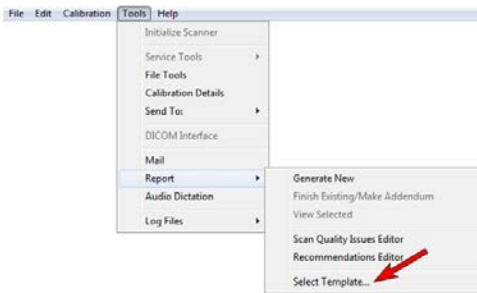

3. When the **Report Configuration** dialog box opens, click a Report Template to highlight it (*Bone Exam Report - 1 Page* was selected here). See "Sample Scan Reports" on page 2-17 for examples of the report template selections. Click .

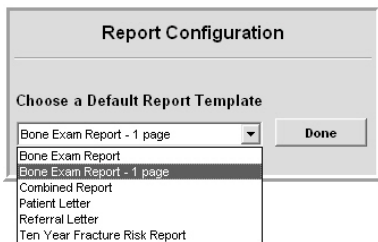

 **Note:** The selected Report Template will remain the default until it is changed. The currently selected Report Template is always displayed at the bottom of the IlluminatusDXA window.

4. Click **Tools > Report > Generate New** or click the  button.

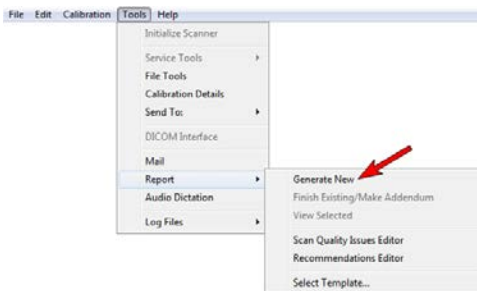

5. The Report is immediately generated and opens up in the window, as shown. At this point, the operator can type in their comments and recommendations, *Lock* it, *Save* it, *Print* it, *Export* it to a PDF file (or a DICOM file) and *Close* it.

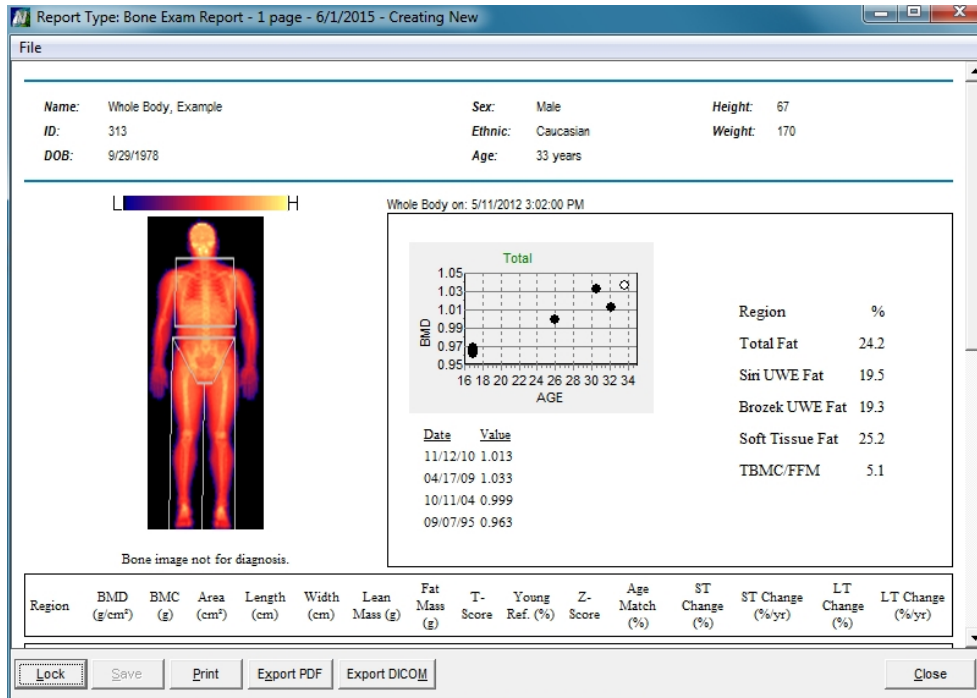

6. Click . The "Print" window appears. Select a printer, select which pages to print and choose how many copies to print.
7. Click to print the Report. The Report is automatically saved and printed.
8. Click .
9. You are returned to the Filmstrip view screen. The saved Report can be found under the "Reports" tab. The Report can be viewed, modified and reprinted at any time. See "The "Reports" Tab" on page 2-14 for more information.

A Sample Bone Exam Report

A sample 2-page Bone Exam Report is included here for reference.

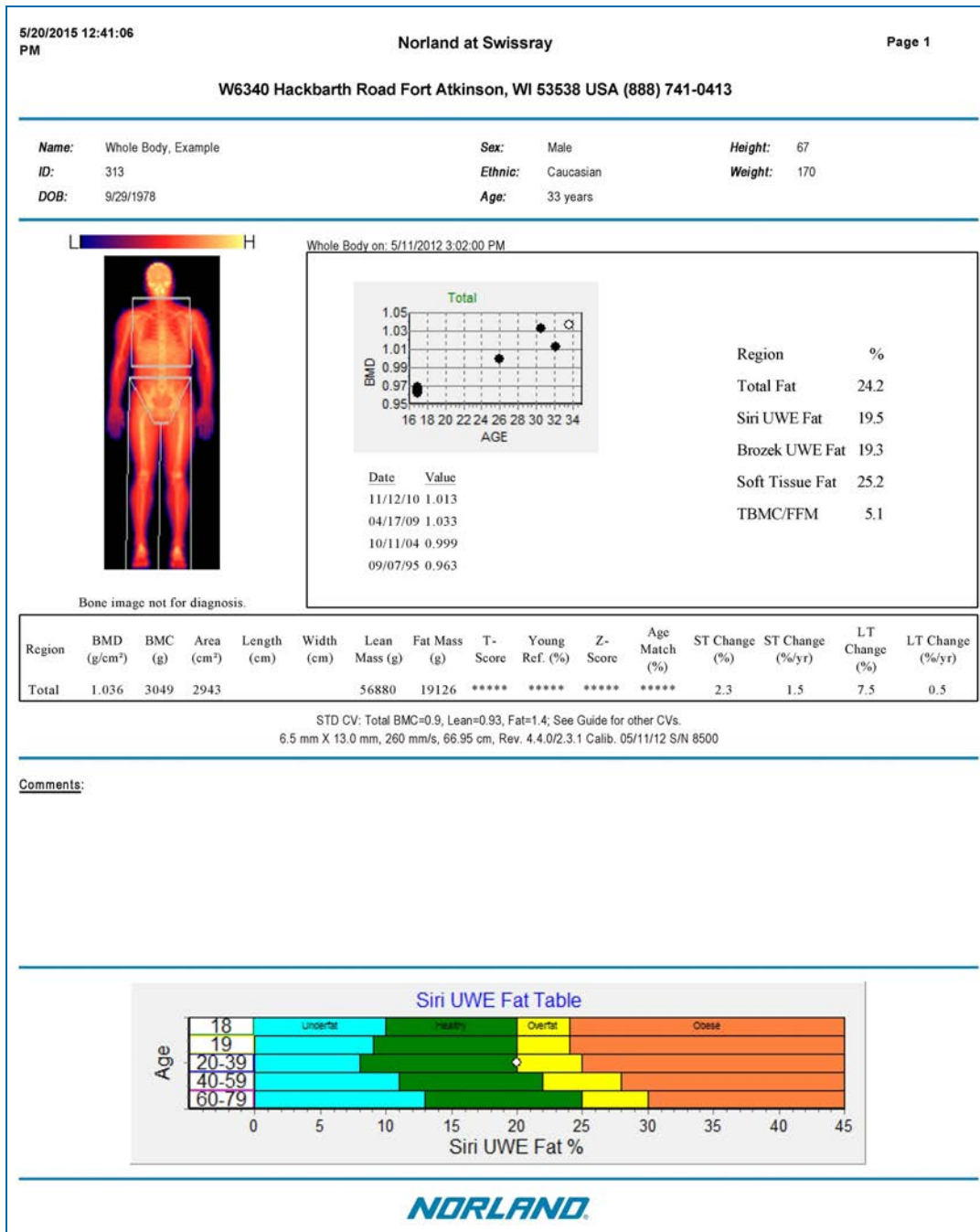

Figure 5-5: Page 1 of the Bone Exam Report

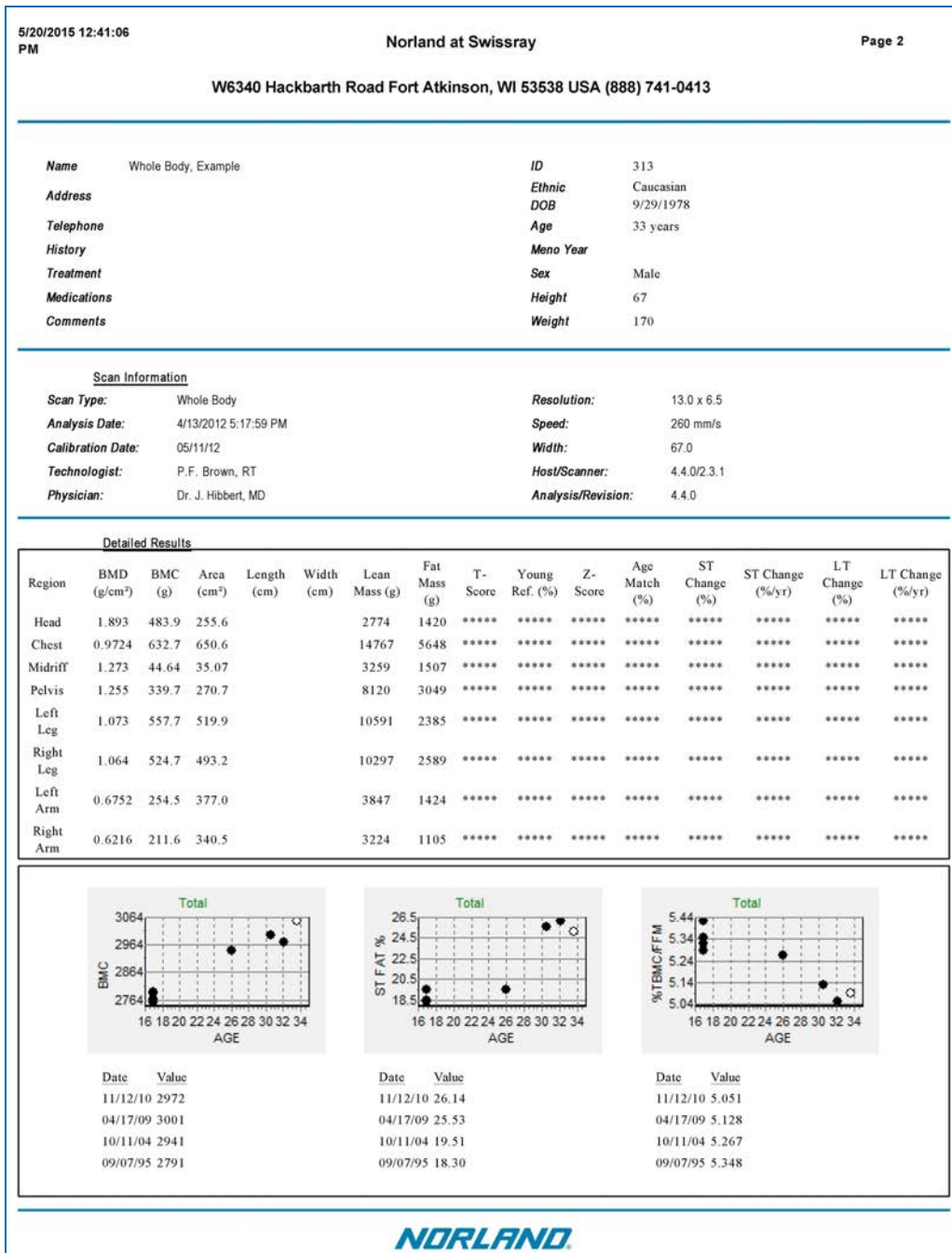

Figure 5-6: Page 2 of the Bone Exam Report

This page intentionally left blank.

CHAPTER 6

Soft Tissue Composition



Note: The Soft Tissue Composition feature and Body Composition Reports are available as an option with the Bone Densitometer. Be aware that your system might not have either of these options.

The Norland Soft Tissue Composition option estimates the lean and fat composition of the soft tissue in the Whole Body, and operator-defined regions of interest on Research and Small Subject scans. It works in conjunction with the Whole Body, Research, and Small Subject scans to provide lean and fat soft tissue mass values in addition to the bone density values.

No additional dose is required to obtain these soft tissue composition values.

This chapter discusses the following.

Introduction	6-2
Tissue Composition Standards	6-2
Scan Specifications	6-3
Whole Body Scans	6-4
Body Fat Charts - Whole Body Scan	6-5
Research & Small Subject Scans	6-6
Generate and Print a Report	6-7
A Sample Bone Exam Report	6-9
A Sample Body Composition Report	6-11

Introduction

When Soft Tissue Composition is resident on the system, soft tissue values are automatically presented for the computer-generated and operator-defined regions of interest on Whole Body scans and for operator-defined regions of interest on Research and Small Subject scans. Refer to the appropriate chapters in this manual for more details on Whole Body and Research and Small Subject scans.

DXA provides independent values of bone mineral content (BMC) and bone mineral density (BMD) and non-bone lean mass (LEAN), as well as fat mass (FAT) from which the true bone mass fraction is calculated for Whole Body scans. (This value must be manually calculated for Research and Small Subject scans.) Siri and Brozek equations for underwater weighing equivalent values are reported in addition to the BMD, BMC, LEAN MASS and FAT MASS values for Whole Body scans.

Using DXA technology to determine fat content is a much quicker and simpler process than underwater weighing (UWW), which is often said to be the “gold standard”. Underwater weighing requires that subjects be able and willing to be completely submerged in water while exhaling rather forcibly. This method is ill suited for subjects who are sick, infirm, unconscious, or afraid of water.

Another advantage of DXA over UWW is its insensitivity to body gas. The effect of gases contained in the body must be compensated for when using underwater weighing, while the x-ray beam used in DXA is unaffected by such gases.

Tissue Composition Standards

The soft tissue assessment is based on the following industry standards:

- » The standard for bone is hydroxyapatite, a substance equal to the mineral component in bone. It is available in purified form as calcium phosphate tribasic, type IV, from the Sigma Chemical Company of St. Louis, Missouri, USA.
- » The standard for fat is stearic acid, a fatty acid which closely approximates the triglyceride esters which make up mammalian fat in molecular composition and in photon attenuation properties.
- » The standard for lean soft tissue is 0.6% sodium chloride in water. This saline solution closely approximates the photon attenuation properties of the various lean soft tissues, such as muscle, blood and skin.

Scan Specifications

Detailed specifications for Soft Tissue Composition are in the following tables.

Table 6-1: Research/Small Subject Scan Specifications

Scan Site	Whole Body: System-defined and operator-defined regions of interest Research and Small Subject: Operator-defined regions of interest
Accuracy ^a	Typically within 2.0%
In vivo Precision ^b	See table below

Table 6-2: Soft Tissue Composition Scan In vivo Precision

	Total Body C.V.	Head C.V.	Trunk C.V.	Abdomen C.V.	Arms C.V.	Legs C.V.
Soft Tissue Mass	0.1%	1.4%	0.81%	2.3%	1.8%	0.57%
Lean Body Mass	0.93%	1.4%	1.6%	2.6%	2.3%	1.5%
Fat Mass	1.4%	1.9%	1.9%	3.7%	4.8%	2.1%
Percent Fat	1.4%	0.91%	1.7%	2.2%	3.5%	2%
*** All specifications are subject to change without notice. ***						

^aStandard for calibration: BONE - hydroxyapatite; FAT - stearic acid; LEAN- 0.6% NaCl in H₂O.

^bBased upon 3 scans each of 14 subjects Whole Body procedures outlined in the Whole Body chapter, using 6.5 X 13mm resolution and 260m-m/sec scan speed.

Whole Body Scans

Soft Tissue Composition - Whole Body Scans

All Soft Tissue values are derived from data acquired during the scan. Soft Tissue values are automatically calculated for all regions of interest when the operator:

1. completes a Whole Body scan
2. performs the routine Analysis (see "Analyzing the Scan" on page 5-15).

When performing serial soft tissue characterizations of the same patient/subject, it is important to position all cursors the same as in the initial (baseline) scan. Use "Comparison Image" on page 11-54 to aid in positioning cursors for serial patients.

Results - Whole Body Scan

Table 6-3: Measured Values

BMC (g)	Bone Mineral Content in grams
Lean Mass (g)	Lean Tissue in grams
Fat Mass (g)	Fat Tissue in grams
Area (cm ²)	Area in squared centimeters

Table 6-4: Calculated Values

Total Fat %	Total Fat Mass/(BMC + LEAN + FAT)
SIRI UWE Fat %	$[(4.95/Dt) - 4.142] * 100$ (Dt = Total Density)
BROZEK UWE Fat %	$[(4.57/Dt) - 4.142] * 100$ (Dt = Total Density)
Soft Tissue Fat %	Fat Mass/(Lean + Fat)
%TBMC/FFM (Total Bone Mineral Content /Fat Free Mass)	Total BMC/(Total BMC + Total Lean Mass)

- » Total Lean Mass (g), Total Fat Mass (g), Total Fat %, Siri and Brozek Underwater Weighing Equivalents (UWE), Soft Tissue Fat % and the %TBMC/FFM values are displayed below the image on page 1 of the Bone Exam Report.
- » Lean and Fat Mass values for head, arms, legs, chest, midriff, pelvis, legs, arms, and total body will also be displayed.
- » SIRI AND BROZEK underwater weighing equivalents are presented for comparisons to DXA % Fat as underwater weighing may be considered the gold standard in fat content determinations.
- » TBMC/FFM is the ratio of Total Bone Mineral Content (bone) to Fat Free Mass (lean tissue).

Body Fat Charts - Whole Body Scan

A Body Fat Chart is displayed on the bottom of page 1 of the Whole Body Bone Exam Report that shows the classification of the patient according to the patient's Siri UWE fat percentage. The chart displayed in the report is based on the patient's age and gender and is derived from the charts shown below:

Male 7-18:

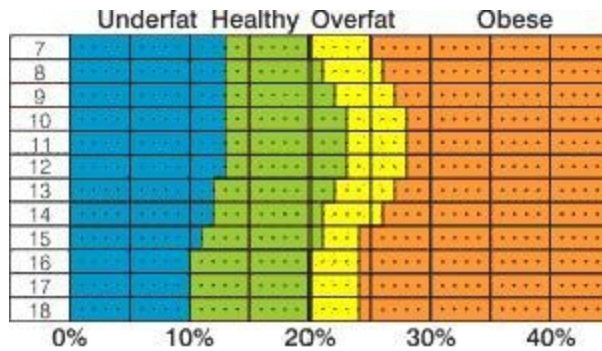

Male 18-79:

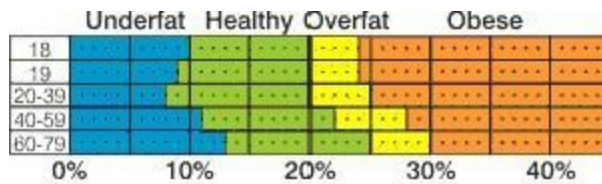

Female 7-18:

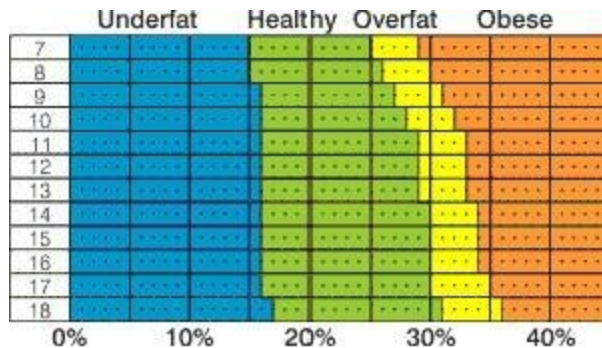

Female 18-79:

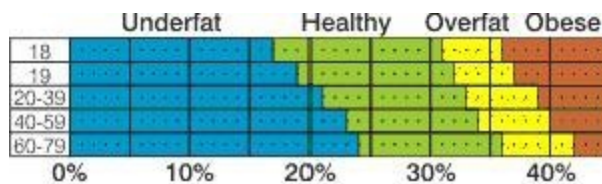

Charts supplied courtesy of Tanita Ltd, data from:

Body Fat Ranges for Standard Children

- » Body Fat Reference Curves for children Targeted at BMJ (British Medical Journal) Draft 1-AMP 19 June (by Dr Andrew)
- » Gallagher D et al. Am J Clin Nutr 2000,72:694-701. "Healthy percentage body fat ranges: an approach for developing guidelines based on body mass index."

Body Fat Ranges for Standard Adults

- » Based on NIH/WHO BMI Guidelines
- » As reported by Gallagher, et al, at NY Obesity Research Center

Research & Small Subject Scans

Soft Tissue Composition - Research & Small Subject Scans

All Soft Tissue values are derived from data acquired during the scan. Soft Tissue values will be calculated for operator-defined regions of interest (see "Special Region Cursors " on page 11-38).

After completing the scan, perform the routine analysis (see "Analyzing the Scan" on page 9-16).

Add and position Special Regions for desired soft tissue calculations. The operator can place up to seven (7) Special Regions on Research or Small Subject scans.

When performing serial soft tissue characterizations of the same subject, it is important to position all cursors the same as in the initial (baseline) scan. Use *Comparison Image* to aid in positioning cursors for serial subjects (see "Comparison Image" on page 11-54).

Results - Research & Small Subject Scans

Lean Mass (g) and Fat Mass (g) values for any operator-defined regions will be displayed in the Bone Exam Report.

Generate and Print a Report

Seven different types of Reports can be generated for each scan: the *Body Composition Report - 1 Page*, the *Body Composition Report*, the *Bone Exam Report*, the *Bone Exam Report - 1 Page*, the *Combined Report*, the *Patient Letter*, and the *Referral Letter*. When saved, these reports become part of the scan data.

These procedures use the *Bone Exam Report - 1 Page* for the example.

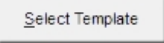
1. Make sure that the scanned image is being viewed as a thumbnail in the **Stamp View** or the **Filmstrip View**. Click (to highlight) the thumbnail view of the scan.
2. Click **Tools > Report > Select Template...** or click the  button to open the "Report Configuration" dialog box.

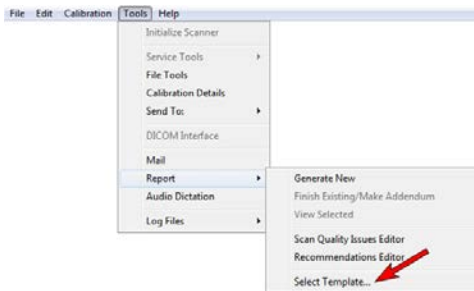

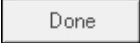
3. When the **Report Configuration** dialog box opens, click a Report Template to highlight it (*Bone Exam Report - 1 Page* was selected here). See "Sample Scan Reports" on page 2-17 for examples of the report template selections. Click .

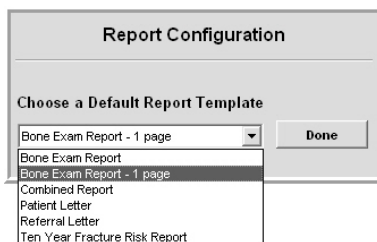

Note: The selected Report Template will remain the default until it is changed. The currently selected Report Template is always displayed at the bottom of the IlluminatusDXA window.

4. Click **Tools > Report > Generate New** or click the  button.

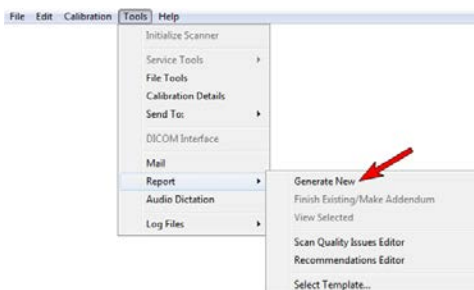

5. The Report is immediately generated and opens up in the window, as shown. At this point, the operator can type in their comments and recommendations, *Lock* it, *Save* it, *Print* it, *Export* it to a PDF file (or a DICOM file) and *Close* it.

Report Type: Bone Exam Report - 1/8/2012 - Creating New

Name: Whole Body Example Ethnic: Caucasian
 ID: Whole Body Height:
 Age: 53 years Weight:
 Sex: Male

Whole Body on: 4/20/2010 6:54:41 AM

Region %
 Total Fat 27
 Sini UWE Fat 24
 Breakdown UWE Fat 24
 Soft Tissue Fat 28
 TBMC/FFM 4

Region	BMD (g/cm ³)	BMC (g)	Area (cm ²)	Length (cm)	Width (cm)	Lean Mass (g)	Fat Mass (g)	T-Score	Young Ref. (%)	Z-Score	Age Match (%)	ST Change (%)	ST Change (1/yr)	LT Change (%)	LT Change (1/yr)
Total	1.174	2219	2627			71289	26282	*****	*****	*****	*****	*****	*****	*****	*****
Head	1.512	422.8	279.7			2949	1996	*****	*****	*****	*****	*****	*****	*****	*****
Chest	1.063	334.8	321.8			18906	8429	*****	*****	*****	*****	*****	*****	*****	*****

STD CV for Total BMC: 1.8 See Guide for other CVs.
 6.5 mm X 13.0 mm, 260 mesh, 64.35 cm, Rev. 4.3 02.3.1 Call: 04/19/10 SAN 0113

Comments:

Sini UWE Fat Table

Age	10	15	20	25	30	35	40	45
10	10	10	10	10	10	10	10	10
15	10	10	10	10	10	10	10	10
20	10	10	10	10	10	10	10	10
25	10	10	10	10	10	10	10	10
30	10	10	10	10	10	10	10	10
35	10	10	10	10	10	10	10	10
40	10	10	10	10	10	10	10	10
45	10	10	10	10	10	10	10	10

Buttons: Lock, Save, Print, Export PDF, Export DICOM, Close

6. Click . The "Print" window appears. Select a printer, select which pages to print and choose how many copies to print.
7. Click to print the Report. The Report is automatically saved and printed.
8. Click .
9. You are returned to the Filmstrip view screen. The saved Report can be found under the "Reports" tab. The Report can be viewed, modified and reprinted at any time. See "The "Reports" Tab" on page 2-14 for more information.

A Sample Bone Exam Report

A sample 2-page *Bone Exam Report* for a Soft Tissue Composition Whole Body Scan:

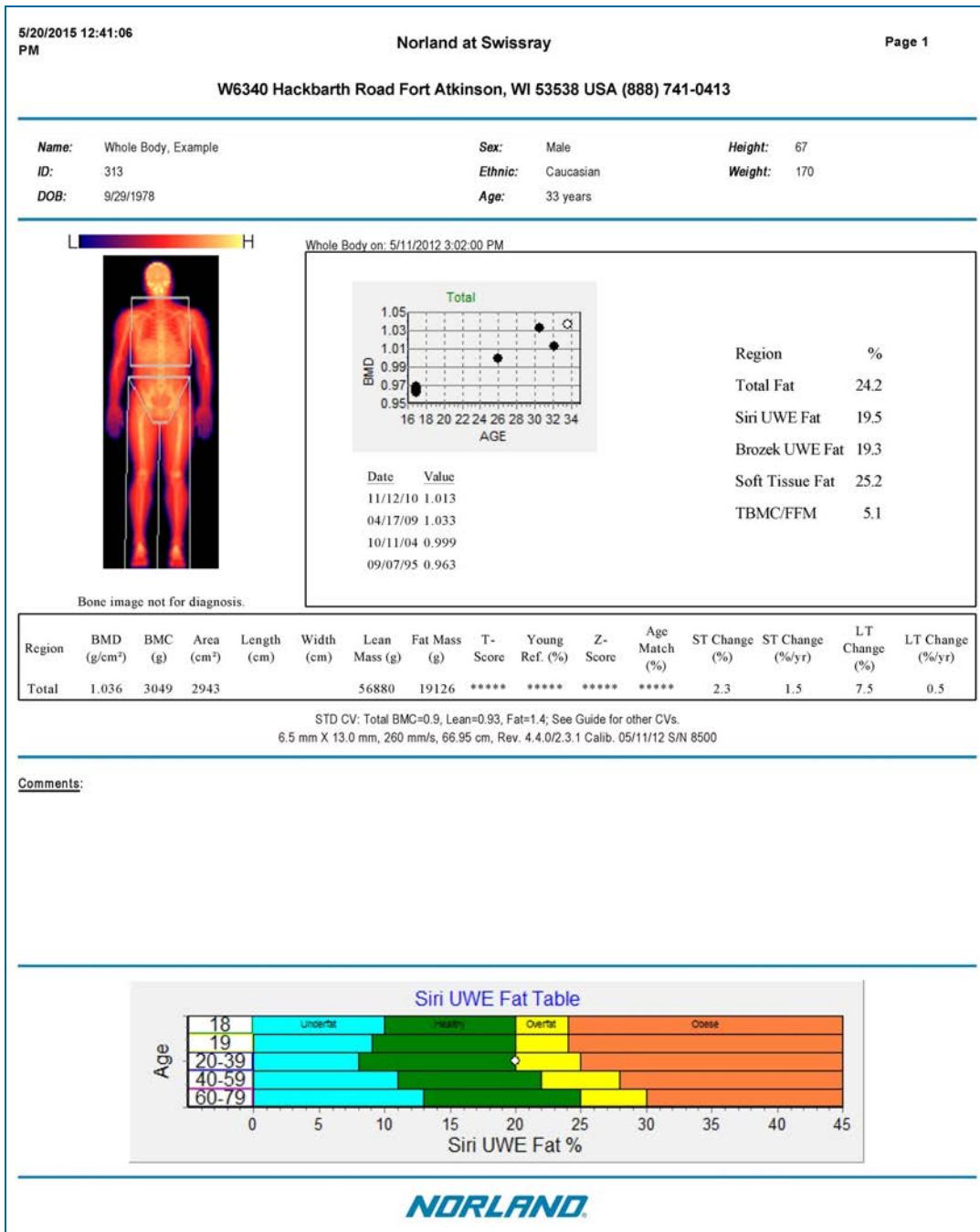

Figure 6-1: Page 1 of the Bone Exam Report

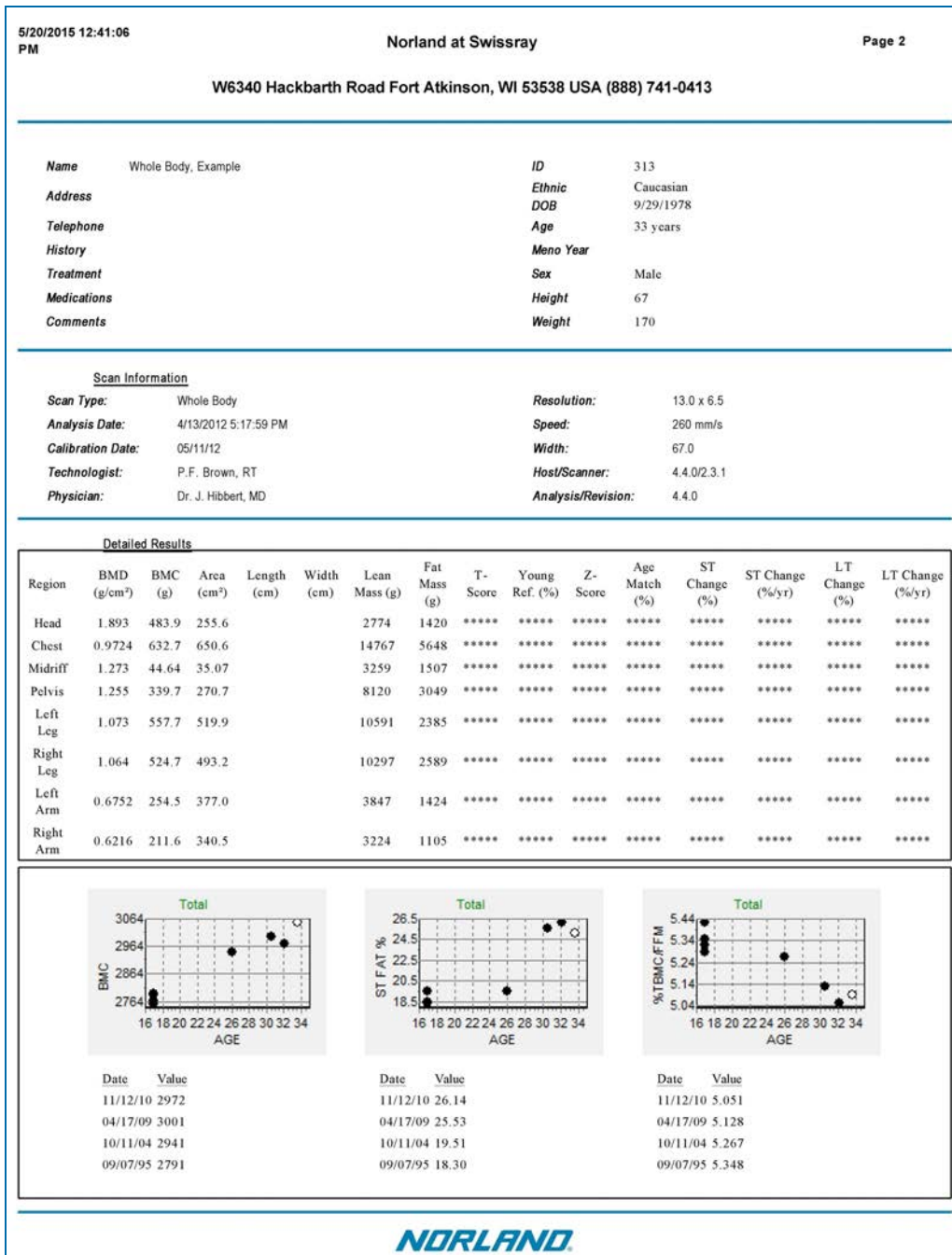
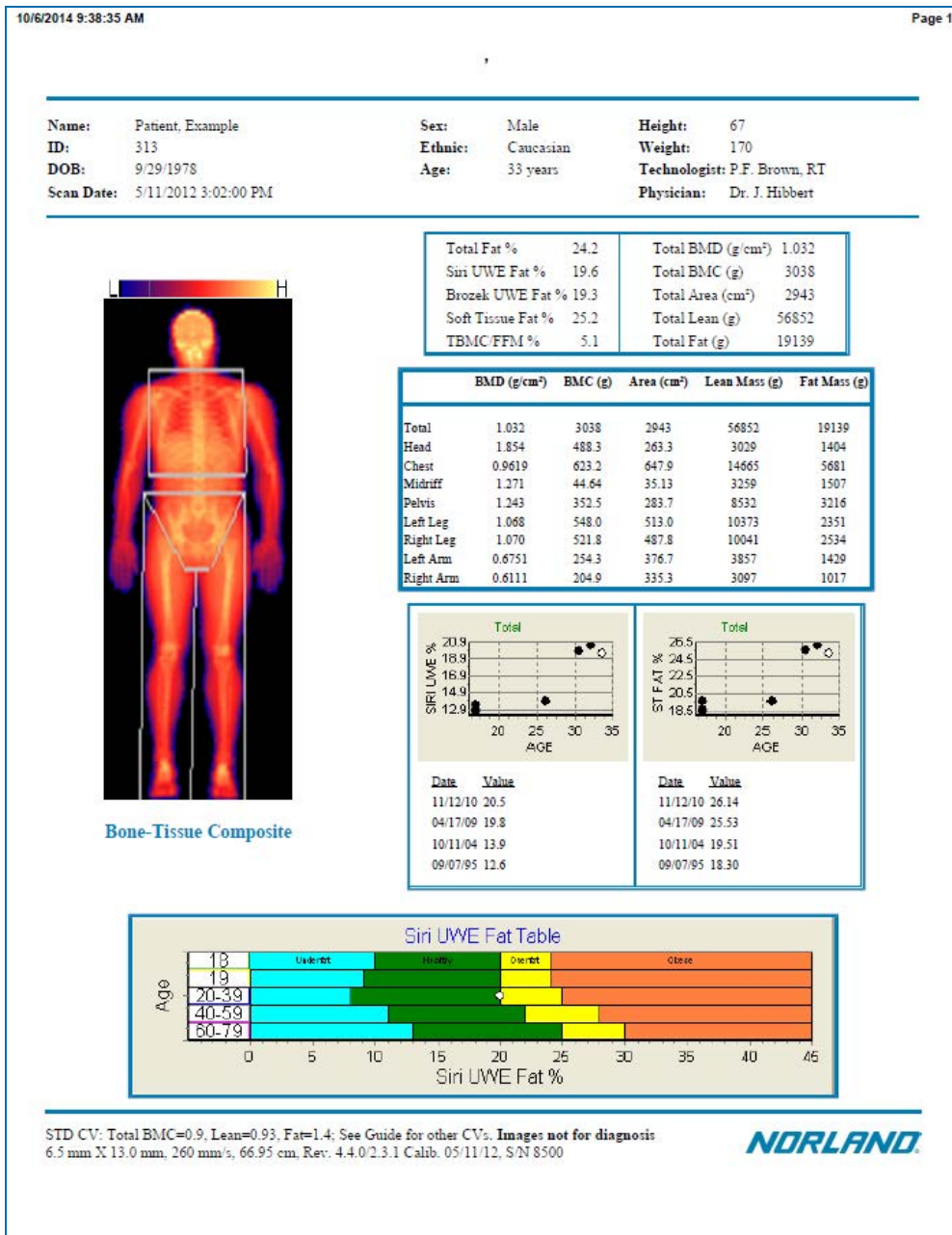

Figure 6-2: Page 2 of the Bone Exam Report

A Sample Body Composition Report

A sample *Body Composition Report* for a Soft Tissue Composition Whole Body Scan with prior trending:



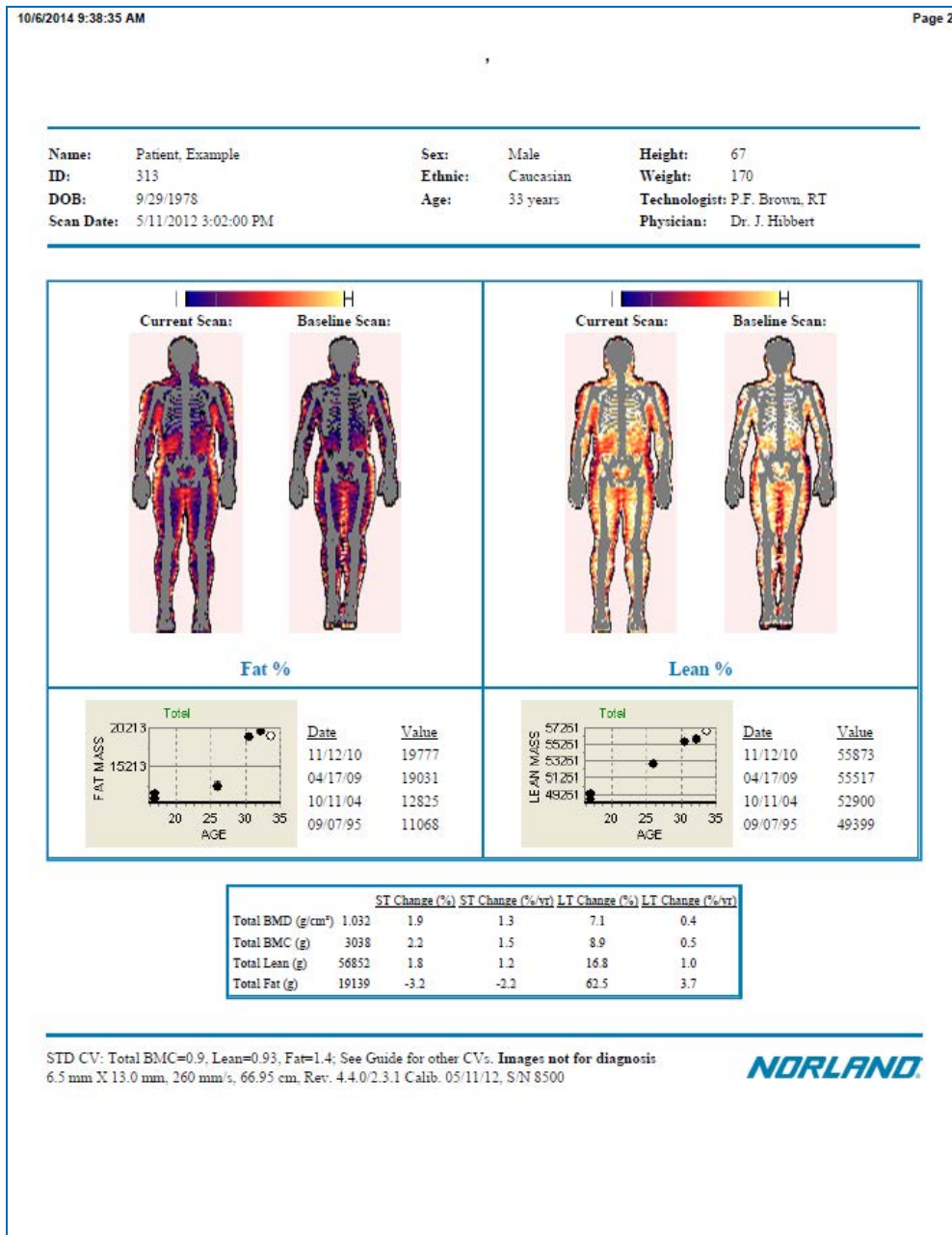

Figure 6-4: Page 2 of the Body Composition Report

CHAPTER 7

Scanning AP Spine

The AP Spine Scan procedure estimates bone mineral in the lumbar spine using a posterior-anterior projection. The scan is typically started at the xiphoid process and ends just below the iliac crests. The scan procedure includes an auto centering routine to ensure the spine is centered and straight in the scan area. The region of interest is the L1-L2-L3-L4 segment, which is analyzed for individual and total vertebrae. The analysis will exclude transverse vertebral process areas from the bone mineral estimations.



Figure 7-1: Patient positioning for the AP Spine Scan

This chapter discusses the following.

Scan Specifications	7-2
Maintaining High Quality AP Spine Scans	7-4
General Patient Scanning Cautions	7-5
Quick Reference - AP Spine Scan	7-6
Scan Procedures	7-7
Analyzing the Scan	7-17
Viewing the Scan Results Tab	7-21
Generate and Print a Report	7-24
A Sample Bone Exam Report	7-26

Scan Specifications

Detailed specifications for the AP Spine Bone Density scan are in the following tables.

Table 7-1: AP Spine Scan Specifications

Scan Sites	Lumbar Spine (L1-L4)
Accuracy ^a	Typically within 1.0% of industry standard
In vivo Precision ^b	See table below
Scan Times	Refer to Technical Reference Section (Performance)
Scan Resolution	Selectable: 1.0mm x 1.0mm 1.5mm x 1.5mm [Point resolution x line spacing (pixel size)]
Scan Speed	Selectable: High Precision - 65mm/sec. Standard - 130mm/sec. High Speed - 260mm/sec.

Table 7-2: AP Spine Scan In vivo Precision

Measure Scan Mode	Measure Scan Speed	Total L2-L4 C.V.			Total L1-L4 C.V.		
		BMD	BMC	AREA	BMD	BMC	AREA
High Speed	260mm/sec	0.84%	1.32%	1.39%	1.05%	1.28%	1.64%
*** All specifications are subject to change without notice. ***							

^aBased on Standard Speed Scans of an anthropomorphic phantom.

^bBased upon scans of 14 subjects, 3 scans each using standard procedures, 1.5 X 1.5mm resolution, and 260mm/sec scan speed.

Patient Dose



Note: The radiation dose to the patient is dependent on the type of scan procedure and the body thickness of the patient. The table below lists typical entrance skin dosages for the AP Spine Measure scan based on the listed body thickness.

Table 7-3: AP Spine Scan Skin Entrance Dose

Patient Thickness (cm)	High Precision (μSv)	Standard (μSv)	High Speed (μSv)
0-3	0.8	0.4	0.2
4-6	1.1	0.6	0.3
7-9	1.6	0.8	0.4
10-12	2.0	1.0	0.5
13-15	3.8	1.9	1.0
16-18	6.5	3.2	1.6
19-21	12.0	6.0	3.0
>21	18.7	9.4	4.7

Operator Dose



Note: The dose to the operator is negligible. During a scan, the radiation level at a distance of one meter from the scanner table is less than 1.0 microsieverts per hour.

Maintaining High Quality AP Spine Scans

Patient positioning, scan and analysis techniques can influence the precision and accuracy of Norland Bone Density estimations. Facilities can reduce the adverse effects of some of these factors by:

- » Performing and monitoring the daily QA procedure to verify that other radiation sources (x-ray machines, nuclear imagers) are not affecting the performance of the Norland system. The daily QA procedure verifies proper operation as well.
- » Ensuring that all operators position patients and analyze data in the same manner.
- » Screening patients for recent radionuclide uptake procedures. Residual emission may be misinterpreted by the Norland system as x-rays.
- » Screening patients for recent ingestion of radiopaque substances. Barium or other dyes used in some x-ray procedures could result in increased soft tissue x-ray absorption.
- » Screening patients for external opaque (metal and plastic) objects. Jewelry, buttons, zippers, rivets, buckles, pens, keys etc. can affect the results if they are in the scanning region.
- » Screening patients for prosthetic devices, implants, surgical staples, or other high density sub-dermal materials that may affect density estimates.
- » Ensuring that scan and analysis parameters remain constant for all scans of the same patient.
- » Ensuring the patient does not move during the scan.

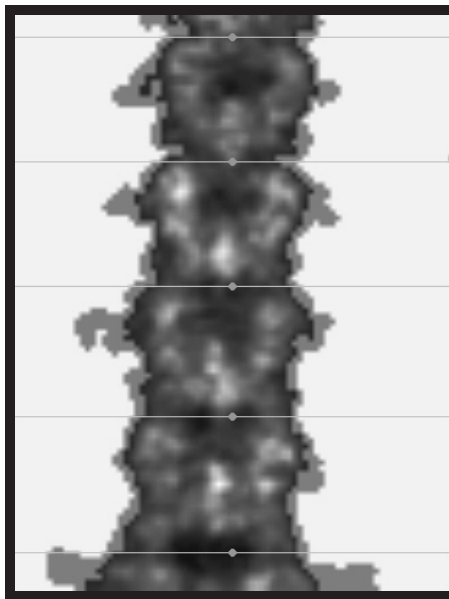

Figure 7-2: Example of a Good Quality AP Spine Scan

- » The vertebral column is centered and straight. Auto Centering helps to ensure that the vertebral column is centered and straight in the scan region.
- » Anatomical landmarks such as the ribs off T12 and the top of the iliac crests are visible in the scan image.

General Patient Scanning Cautions



Caution: Properly Mark the Patient. To ensure scanner arm does not contact the patient, always verify patient is positioned properly before scanning or moving the scanner arm.



Caution: Do not move the patient while marking the regions to be scanned. Always remain near the patient, in the event assistance is needed.



Caution: Do not touch the patient and the computer system at the same time as this could increase leakage currents.



Caution: Do not reach around to the back of the unit while the scanner arm is moving. While guards are provided, it is wise to avoid any chance of pinching the arm, hand, or fingers between the scanner arm and the frame, or between the source and the scanner arm.



Caution: Do not allow the patient to bump, push, or lean on the scanner arm. Manually moving the arm could result in an error message which will require removing the patient from the table and doing the Find Table Dimensions routine.



Caution: Make certain the patient does not dangle their arm or hand over the riser while the scanner arm is moving during a scan. The scan will not be usable, as the patient will not be properly positioned, and the patient may be at risk of pinching their hand or finger between the scanner arm and the riser or between the x-ray source and the scanner arm.



Caution: Make certain the patient does not stick a finger into the slot in the bottom of the upper arm cover during a scan; it could be pinched.



Caution: When positioning the patient, ensure they start by sitting near the center of the table and then swing their legs up. Sitting at either end makes positioning awkward.



Caution: Caution the patient to remain still during the scan to ensure quality results.



Caution: Help the patient up from the scanner after scan data collection; some patients may require a few minutes to regain equilibrium after lying down for a length of time.

Quick Reference - AP Spine Scan

The AP Spine scan takes measurements from L1 through L4.

- » Screen patient for contraindications.
- » In the Database Navigator window, click on the *existing* patient's name, then click OR click to start a *new* record.
- » Update (or enter) the patient's Demographic information.
- » Click . Click the AP Spine button. Click . Check the parameters.
- » Position the patient face up in center of the scanner table. Position the scanner arm over the patient's mid-section. Use the leg rest block to stretch the spine and relax the curvature.



Caution: Caution the patient not to stare into the beam.

- » Click in the Parameters tab window.
- » **MARKING THE START POINT:** Turn ON the laser. Move the scanner arm until the laser dot is positioned 1-cm below the xiphoid process and then press the button on the Scanner Arm Touch Pad.
- » **MARKING THE END POINT:** Move the scanner arm so that the laser dot is positioned 2-cm below the iliac crests and press the button.
- » Click to begin the Measure Scan. Allow the scan to complete.
- » If the scan is satisfactory, click .
- » Select the region type to be analyzed: L1 - L4 L2 - L4
- » Click and hold the control points to move the cursors. Position the top line near the top of L2.
- » Position the bottom line near the bottom of L4.
- » Click .
- » Confirm that cursors are set between T12/L1 (if applicable), L1/L2, L2/L3, L3/L4, and L4/L5. Move if necessary.
- » If you are done scanning, remove the Leg Rest, move the scanner arm and assist the patient up from the table.
- » Click .
- » Click .
- » Click to print a Report (or click to end the process and return to the main window).
- » Click and then .

Scan Procedures

Checklist

You are almost ready to begin scanning. Confirm that the following tasks have been completed:

- » the system is running (see "Powering Up the System " on page 4-3)
- » the System Calibrations are done (see "Daily Calibration Procedure" on page 4-6)
- » the Database Navigator window is open (Figure 4-3: on page 4-5)

Preparing the Patient for Scanning

Ensure that the patient has removed all items from their pockets and that clothing is free of metal (i.e. rivets, buttons, zippers) or anything else that might be of a high density. It might be necessary to have the patient change to an examination gown or robe. Shoes should also be removed.

Update (or Create) the Patient's Record

EXISTING PATIENT: From the Database Navigator window, double-click on the existing patient's name to open the patient's record. Update the patient's information. (If necessary, refer to "Enter Data into the Existing Patient's Record" on page 4-24 for instructions.)

You are now ready to begin the scan process.

Proceed with "Setting the Scan Parameters" on the next page to continue.

NEW PATIENT: From the Database Navigator window, click on  to start a new record. Enter all the patient information. (If necessary, refer to "Preparing Patient Records" on page 4-21 for instructions.)

You are now ready to begin the scan process.

Proceed with "Setting the Scan Parameters" on the next page to continue.

Setting the Scan Parameters

1. Click .
2. Click AP Spine in the pop-up window.

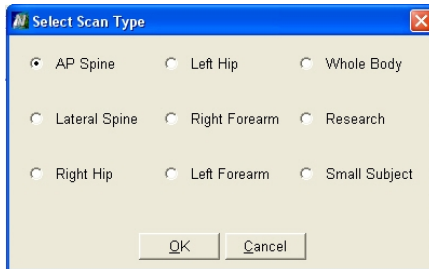

3. Click .
4. The Parameters tab window opens.

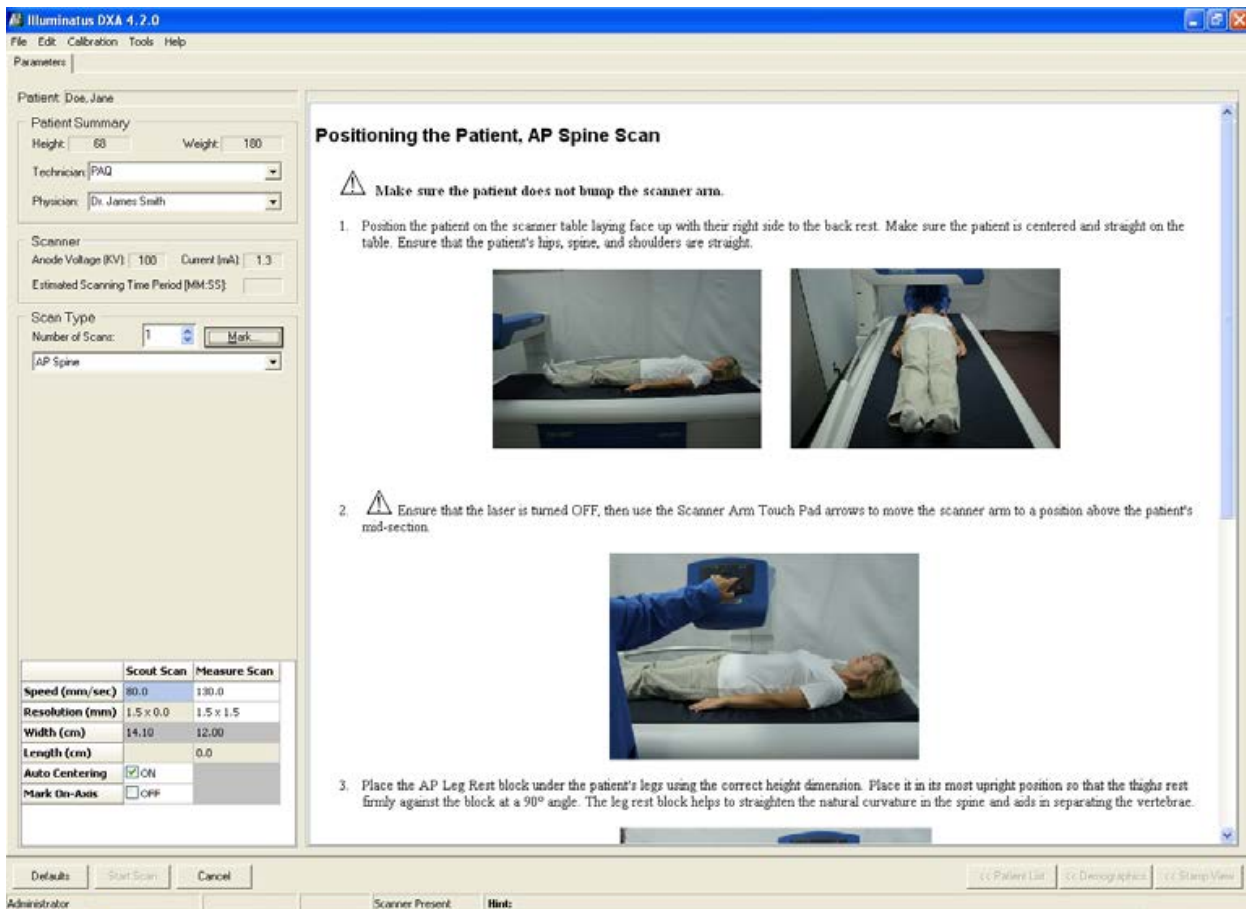

Figure 7-3: The AP Spine Scan Parameters tab window

5. The scan parameters are shown in the bottom left hand side of the Parameters tab window, and reproduced here for reference. Norland recommends that the factory default parameter settings be used for scanning. The default values are shown below.

	Scout Scan	Measure Scan
Speed (mm/sec)	80.0	130.0
Resolution (mm)	1.5 × 0.0	1.5 × 1.5
Width (cm)	14.10	12.00
Length (cm)		0.0
Auto Centering	<input checked="" type="checkbox"/> ON	
Mark On-Axis	<input type="checkbox"/> OFF	

- » To reset values to factory defaults, see "Preferences: AP Spine Scan" on page 3-24.
 - » For a full explanation of the AP Spine Scan parameters (i.e. preferences) see "Preferences: AP Spine Scan" on page 3-24.
 - » If it is necessary to change the *Speed*, *Resolution*, *Auto Centering* or *Mark On-Axis* parameters, see "Changing the Scan Parameters Prior to Scanning" on page 11-63.
6. If you want the *Auto Centering* feature to function at its full capabilities, confirm that the *Auto Centering* is checked (ON) and that the *Mark On-Axis* is not checked (OFF).
7. Proceed to "Positioning the Patient" on the next page to continue.



Positioning the Patient

Refer to the patient positioning photos and instructions in the Norland software (Parameters tab window). The steps and photos are reprinted in the manual for reference.

The screenshot shows the 'Parameters' window in the 'Illuminatus DXA 4.7.0' software. The window is titled 'Positioning the Patient, AP Spine Scan' and contains the following instructions and images:

Positioning the Patient, AP Spine Scan

⚠ Make sure the patient does not bump the scanner arm.

1. Position the patient on the scanner table laying face up with their right side to the back rest. Make sure the patient is centered and straight on the table. Ensure that the patient's hips, spine, and shoulders are straight.
 
2. ⚠ Ensure that the laser is turned OFF, then use the Scanner Arm Touch Pad arrows to move the scanner arm to a position above the patient's mid-section.
 
3. Place the AP Leg Rest block under the patient's legs using the correct height dimension. Place it in its most upright position so that the thighs rest firmly against the block at a 90° angle. The leg rest block helps to straighten the natural curvature in the spine and aids in separating the vertebrae.
 

Below the instructions is a table with scan parameters:

	Scout Scan	Measure Scan
Speed (mm/sec)	80.0	130.0
Resolution (mm)	1.5 x 0.0	1.5 x 1.5
Width (cm)	14.10	12.00
Length (cm)		0.0
Auto Centering	<input checked="" type="checkbox"/> ON	
Mark On-Axis	<input type="checkbox"/> OFF	

At the bottom of the window are buttons for 'Defaults', 'Start Scan', and 'Cancel', along with a status bar showing 'Administrator', 'Scanner Present', and 'Hint'.



Caution: Make sure the patient does not bump the scanner arm.

1. Position the patient on the scanner table laying face up with their right side to the back rest. Make sure the patient is centered and straight on the table. Ensure that the patient's hips, spine, and shoulders are straight.



2. ⚠ Ensure that the laser is turned OFF, then use the Scanner Arm Touch Pad arrows to move the scanner arm to a position above the patient's mid-section.



3. Place the AP Leg Rest block under the patient's legs using the correct height dimension. Place it in its most upright position so that the thighs rest firmly against the block at a 90° angle. The leg rest block helps to straighten the natural curvature in the spine and aids in separating the vertebrae.



4. Ensure that the patient's hands are not in the scan area. Place them at the patient's sides on the table.



5. The patient is now ready for scanning.
6. Make the patient as comfortable as possible since movement during the scan will affect the results. The use of a sheet or light blanket will not interfere with the scan results. The use of a pillow under the head is recommended.

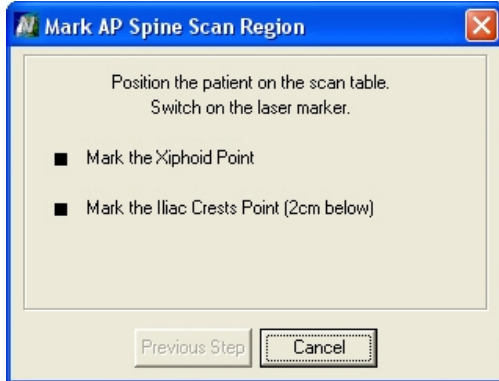

Marking the Scan Region

1. Click  in the Parameters tab window to open the dialog box.



Caution: Caution the patient not to stare into the beam.



2. Press  to turn the laser ON.
3. **MARKING THE START POINT:** move the scanner arm until the dot is positioned at the xiphoid point and press . (The computer will emit a sound, and the laser will flash.)

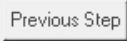
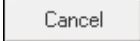

Note: Click  in the dialog box to re-mark the Xiphoid Point. Click  at any time to abort the marking operation.



Caution: Take care not to bump the patient's legs with the scanner arm in the next step. If the scanner arm movement is interrupted or if the patient moves, the start and end marks may have to be re-identified.

4. **MARKING THE END POINT:** move the scanner arm until the dot is positioned 2-cm below the iliac crests (see the figure below) and press . (The computer will emit a sound and the laser will flash.)



5. The dialog box will automatically close when the marking tasks are complete.

Starting the Measure Scan

Caution the patient to remain still.



Remember, press the Emergency Stop button directly below the Scanner Arm Touch Pad to immediately terminate the x-ray exposure or stop the scanner arm movement. Refer to "Pressing the Emergency Stop Button" on page 11-37 for instructions on safely resuming the scan.

1. Click .
2. If the Auto Centering parameter box is checked (ON = enabled), the scanner arm will take a "U" shaped scan before it does the Measure scan.



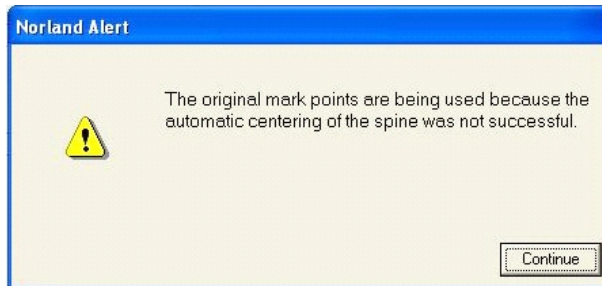

Note: If the "U" shaped scan is not successful, the following alert box will be displayed. In this case, Norland recommends that the scan be terminated and the scan region be re-marked. (Note that marking too high or too low on the spine caused the Auto Centering to fail.) Proceed to "Auto Centering Mode" on page 11-65 for further instructions.



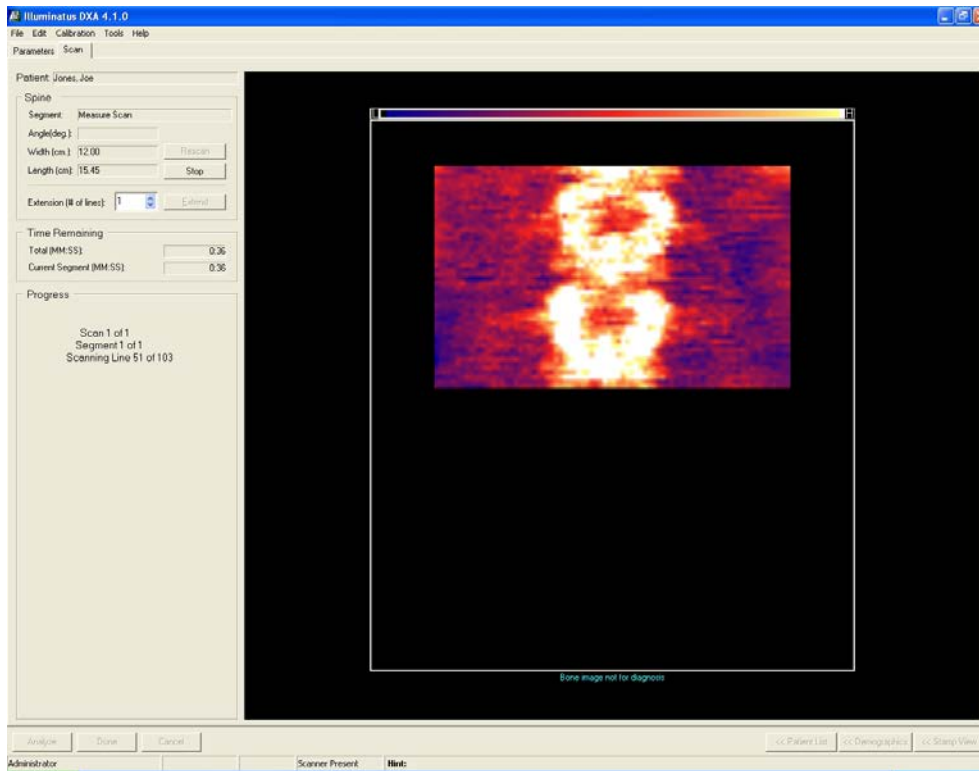

3. The Scan tab window displays the image as it develops, shows how many lines will be scanned and gives an estimate of the total time remaining in the Measure scan.

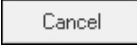
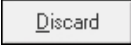

4. Monitor the image closely for any indication of patient movement. Cancel the scan immediately if the patient moves during the scan.

 **Note:** To cancel the scan: Click . Lower the patient's legs by removing the AP Leg Rest.

Click . Select  in the dialog box. Click .

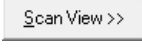
Click . Click . Select AP Spine.

Return to "Marking the Scan Region" on page 7-12 to continue.

5. When the Measure Scan is complete, the computer will emit a sound. The software will update the Scan tab window and the *Analyze* button will become available.

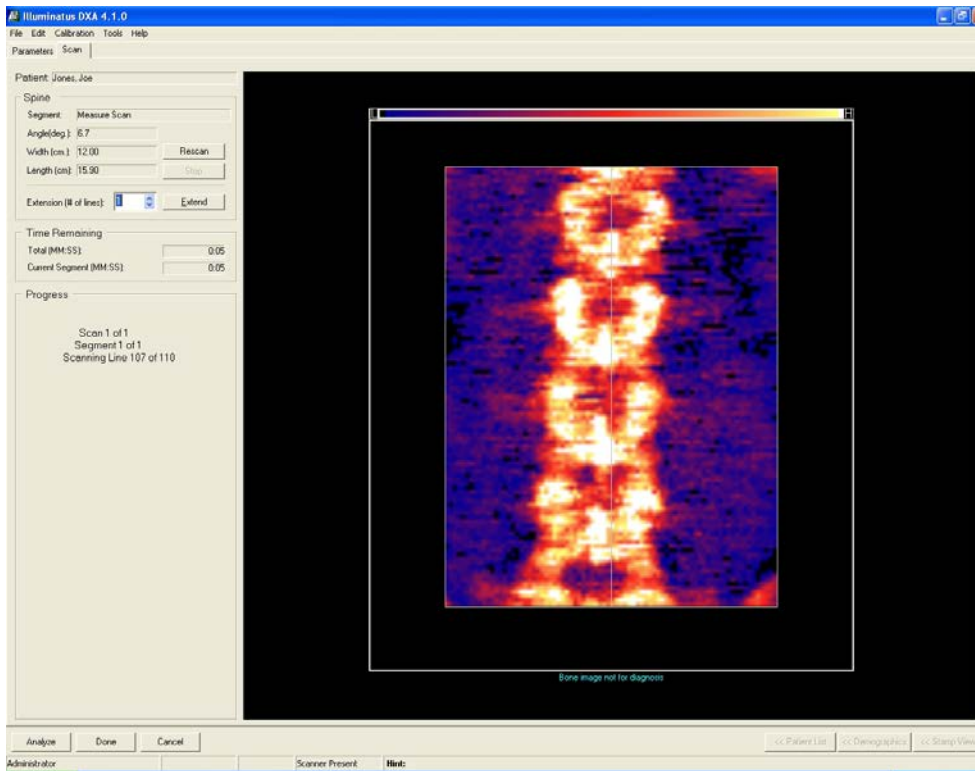

6. Determine if the quality of the Measure Scan image is satisfactory or unsatisfactory.
7. **THE IMAGE IS SATISFACTORY** when the image shows L1-L4, is centered and straight, and landmarks such as the iliac crest appears in the region of interest. Proceed to step 10.
8. **THE IMAGE IS UNSATISFACTORY** if the iliac crest does not appear in the region of interest. You must extend the measurement scan to include the necessary landmarks in the region of interest
9. If necessary, proceed to the steps in "Unsatisfactory Measure Scan (AP Spine)" on page 11-64 to re-do the Measure scan.
10. Remove the leg rest and move the scanner arm out of the way if no further scans are to be performed. Help the patient up from the scanner table.



Caution: Remember that some patients may require a few minutes to regain equilibrium after lying down for a length of time.

Analyzing the Scan

At this point, the operator can analyze the scan later, or analyze the scan now.

ANALYZE LATER: Click to end the scan process and analyze the scan later. The scan data will be saved to the database for analysis at a later time. The software will go back to the Parameter tab window. You can do another type of scan, if desired.

OR ANALYZE NOW . . .

1. Click .
2. In the dialog box that pops up, select the region to be analyzed: L1 - L4 L2 - L4.

 **Note:** Only use L2-L4 if L1 does not exist.

3. When the Analysis tab window opens, cursors will be displayed in the regions of interest.

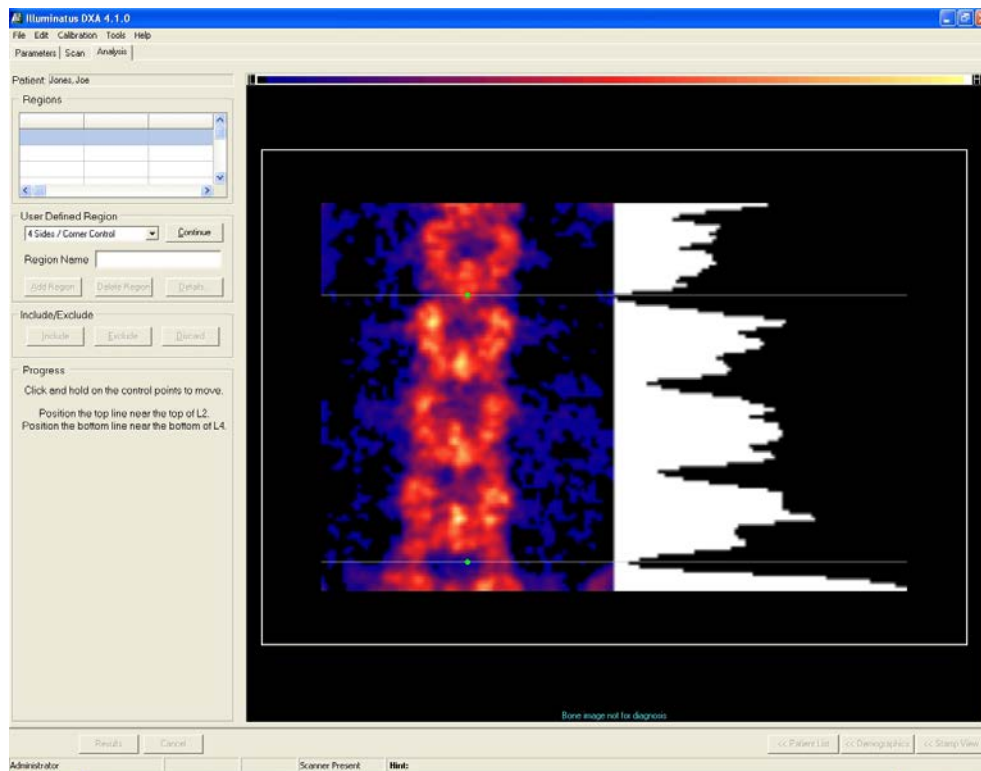

 **Note: Explanation:** The image of the scanned spine is displayed in the window with a histogram to the right. The histogram is a line-by-line graphic presentation of the bone mineral content. The “valleys” of the histogram represent areas of low bone mineral content (BMC); longer lines denote higher BMC. In a normal spine, the BMC value will be the lowest at the intervertebral gaps, so the cursors should be positioned on the shortest histogram lines.

- Using the click and drag method, position the top cursor at the top of L2.
- Position the bottom cursor at the bottom of L4.

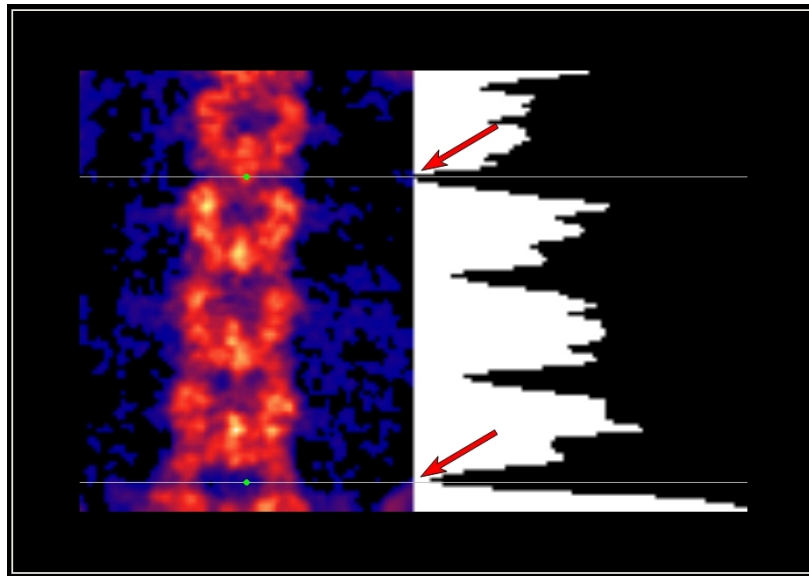

- Click .
- If the spine is so compressed that the software can not automatically find the vertebral gaps, the following dialog box will be displayed. Click **Continue**.

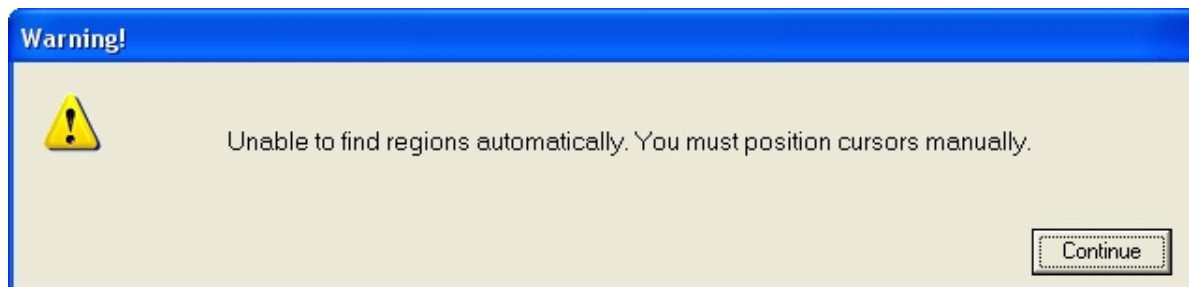

- The Analysis tab window will refresh and add in two more cursor lines for L2-L4 analysis and three more cursor lines for L1-L4 analysis.

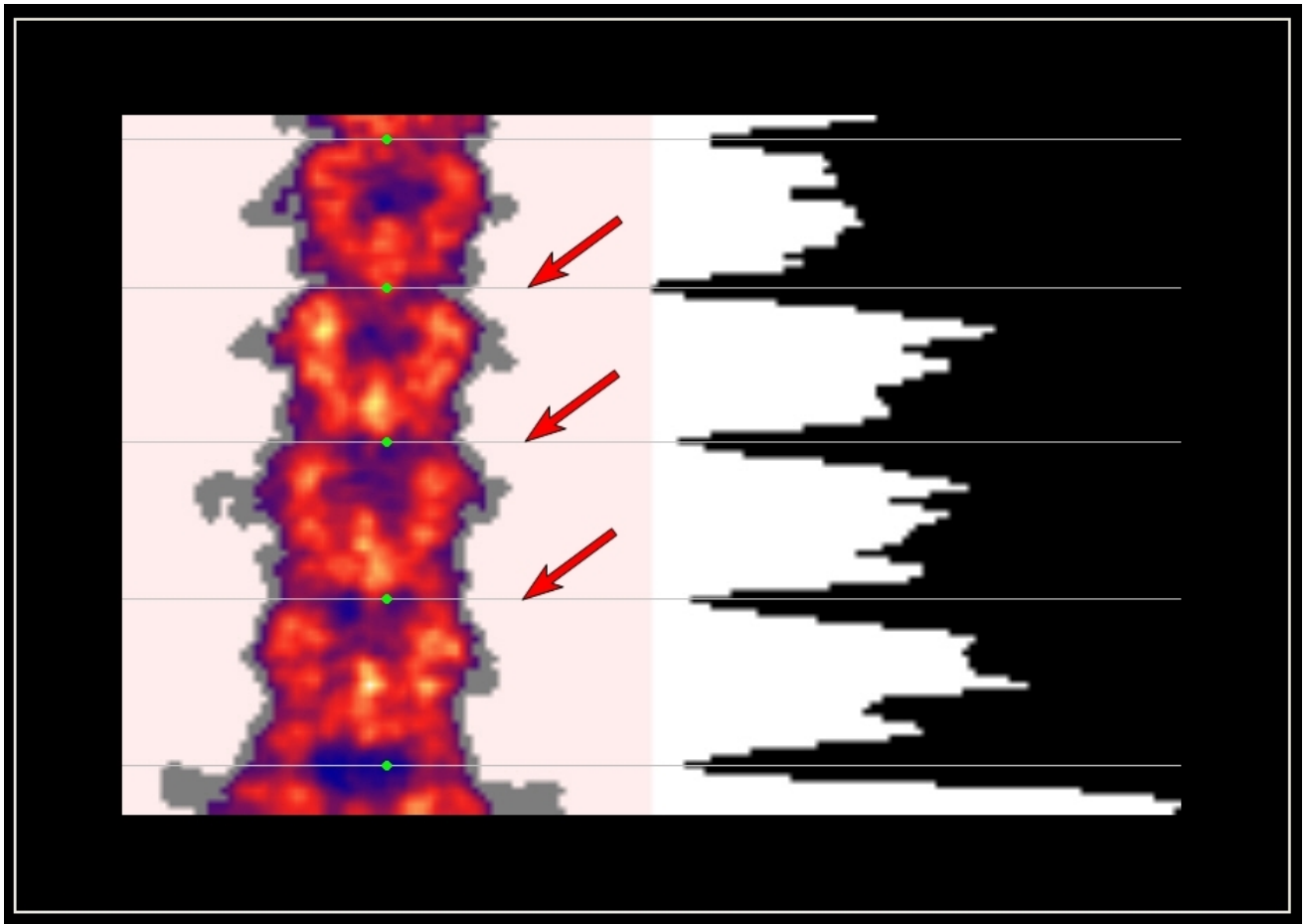

9. If the regions of interest aren't positioned properly, move the cursors.
 - » If this is the patient's *first* AP Spine scan, click on individual control points and drag to move horizontal lines independently of each other.
 - » If this is a *subsequent* AP Spine scan, click on any line within a vertebral body (but not on the control point) and drag to move cursors as a group.
10. Position cursors at the valleys of the histogram.
 - » If patient has been scanned previously, modify cursors to match the Comparison Image. Right-click on the image, select **Image Analysis > Show Comparison**. (See "Comparison Image" on page 11-54).
 - » If patient has scoliosis, it may be necessary to adjust the angles of the cursors to align with vertebral gaps. See "Angulated Cursors" on page 11-67.
 - » If the patient was previously scanned, the original inter-vertebral spacing will be used for the current scan.
11. When all the adjusting is finished, the window should look something like the figure below. The Results button is now available.

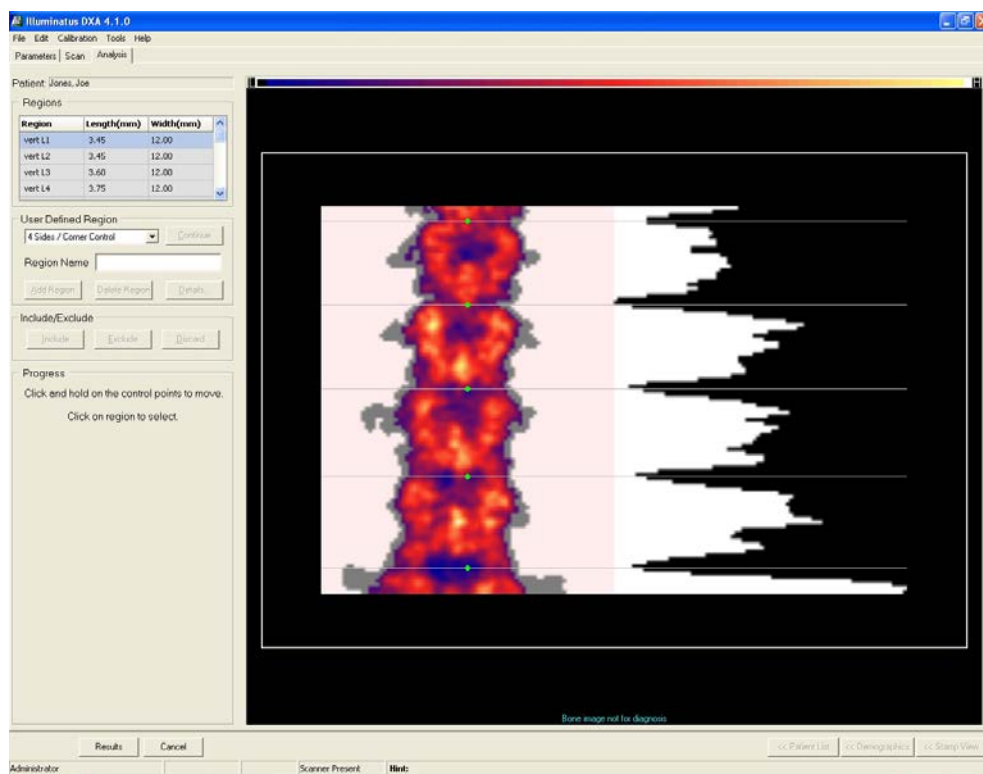

Viewing the Scan Results Tab

1. Click . The Scan Results tab window opens.

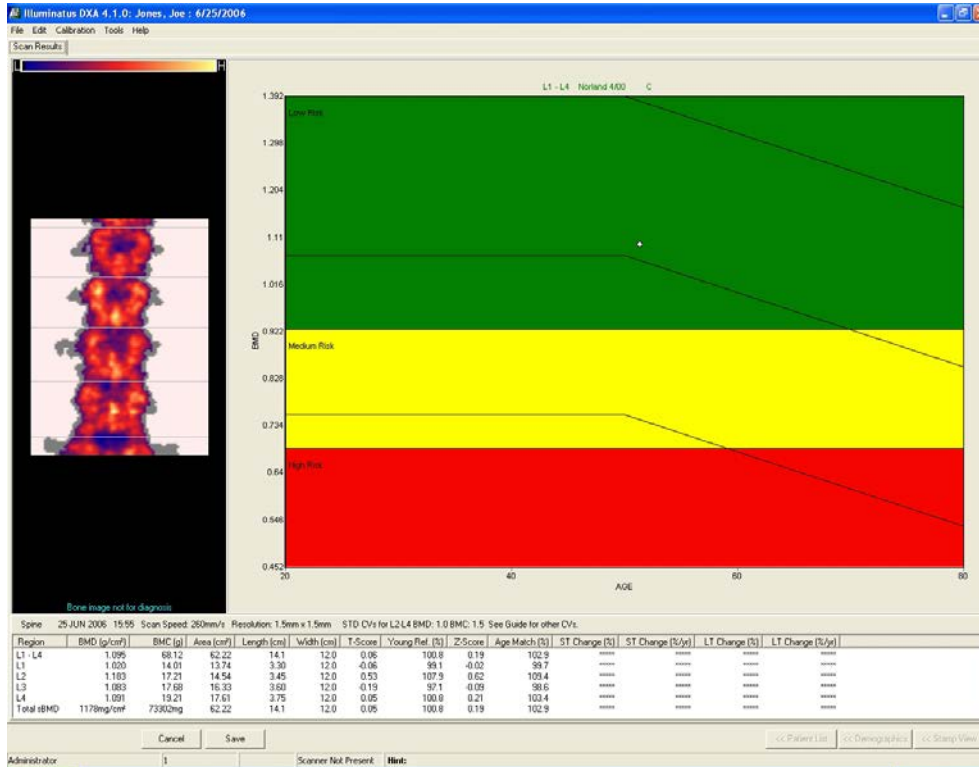

2. Click .
 - » The image thumbnail, trending or reference population graphs, and a results table are displayed in the Scan Results tab. (NOTE: image is not for diagnostic purposes.)
 - » If an exact match of the installed Reference Sets and the ethnic background (entered into the Patient Demographics window) does not exist, the Scan Results tab window will be displayed without a reference population graph.
 - » The BMD of the first region of the Detailed Results will be plotted in the reference chart as a dot.
 - » Detailed Results for each individual vertebrae, L1-L4 or L2-L4, and Total sBMD are displayed in the table at the bottom of the window.
 - » Reference graphs for individual vertebral bodies can be displayed by clicking on the ROI in the Results table. The graph will change according to what is selected. Notice that the name of the selected ROI is displayed at the top of the Reference graph.

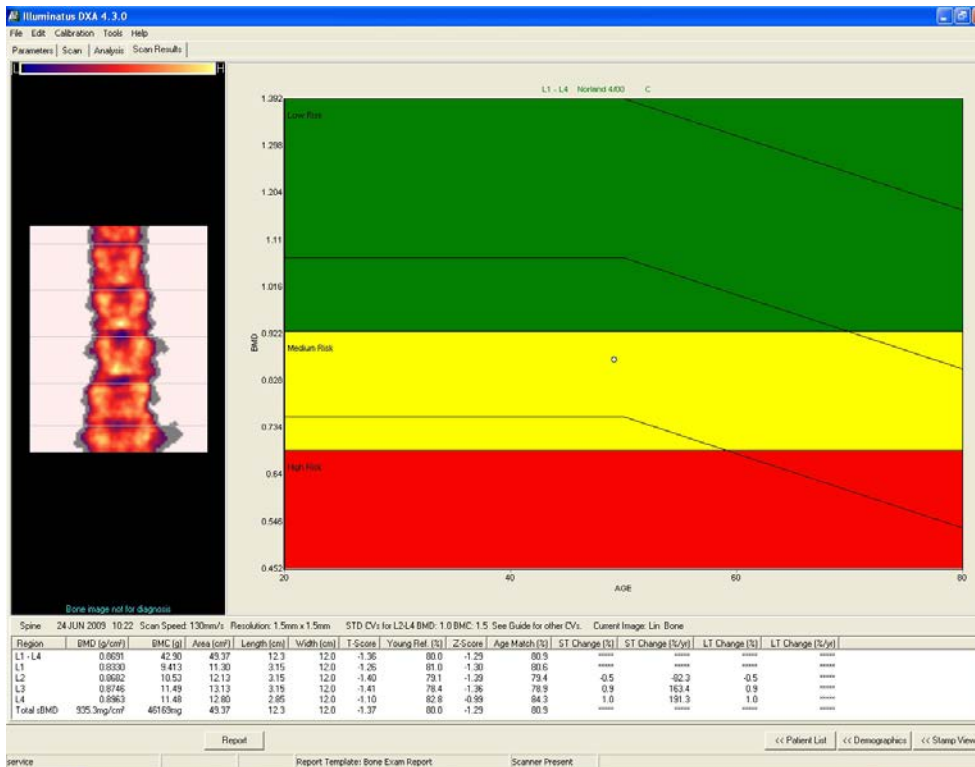

- » Click **Report** to generate and print a report using the current default report template. Proceed to Step 5 of "Generate and Print a Report" on page 7-24.
- » or click **Stamp View >>** to generate and print a report using a report template other than the default. Proceed to "Generate and Print a Report" on page 7-24.
- » or click **Demographics >>** to do another scan.
- » or click **<< Patient List** to end the process and return to the main window.

Definitions of Scan Results

Table 7-4: Definition of Scan Results

T-SCORE	The T-score is the number of standard deviations a patient's BMD value is above or below a young reference value for individuals of same ethnic background and gender.
% YOUNG REFERENCE	The % Young reference value is the ratio of the patient's bone mass to the young reference value for individuals of same ethnic background and gender.
Z-SCORE	The Z-score is the number of standard deviations that the patient's BMD value is above or below the reference value for individuals of same age, ethnic background and gender.
% AGE-MATCHED	The % Age-matched value is the ratio of the patient's bone mass to the reference bone mass value of individuals of the same age, ethnic background and gender.
% ST: SHORT TERM CHANGE	Ratio of change between current scan and most recent previous scan.
% LT: LONG TERM CHANGE	Ratio of change between current scan and patient's initial scan.
%/YR value	Indicates the percent of ST or LT change calculated per year.

Fracture Risk Assessment

The patient's risk of fracture is plotted in the Reference Charts displayed in the Scan Results tab window. Norland incorporates the WHO (World Health Organization) criteria in plotting a patient's fracture risk assessment. See table below. (Note that this table is re-reprinted here for reference.)

Table 7-5: WHO Criteria: Fracture Risk Assessment

Low Risk (Green)	Represents the range of values determined by WHO to be 'normal' (having adequate bone mineral). The BMD T-Score values in this region are within 1 SD of the young adult reference mean value. A patient whose value is plotted in this region has no identifiable risk of fracture.
Medium Risk (Yellow)	Represents the range of values determined by WHO to be 'osteopenic' (having low bone mineral). The BMD T-Score values in this region range are more than 1 SD below the young adult mean value but less than 2.5 SD below the mean value. A patient whose value is plotted in this region may be developing a tendency to fracture.
High Risk (Red)	Represents the range of values determined by WHO to be 'osteoporotic' (having severely reduced bone mineral). The BMD T-Score values in this region are more than 2.5 SD below the young adult mean. A patient whose value is plotted in this region has a high spontaneous fracture probability.

Generate and Print a Report

Five different types of Reports can be generated for each scan: the *Bone Exam Report*, the *Bone Exam Report - 1 Page*, the *Combined Report*, the *Patient Letter*, and the *Referral Letter*. When saved, these reports become part of the scan data.

These procedures use the *Bone Exam Report - 1 Page* for the example.

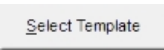
1. Make sure that the scanned image is being viewed as a thumbnail in the **Stamp View** or the **Filmstrip View**. Click (to highlight) the thumbnail view of the scan.
2. Click **Tools > Report > Select Template...** or click the  button to open the "Report Configuration" dialog box.

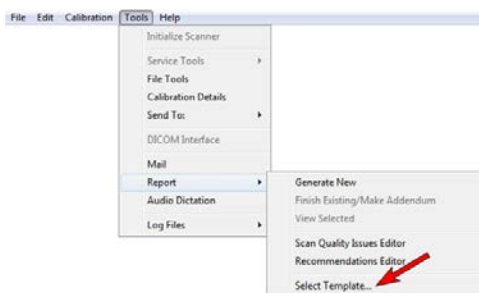

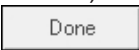
3. When the **Report Configuration** dialog box opens, click a Report Template to highlight it (*Bone Exam Report - 1 Page* was selected here). See "Sample Scan Reports" on page 2-17 for examples of the report template selections. Click .

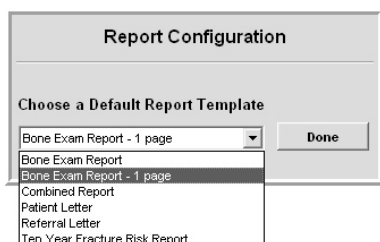

Note: The selected Report Template will remain the default until it is changed. The currently selected Report Template is always displayed at the bottom of the IlluminatusDXA window.

4. Click **Tools > Report > Generate New** or click the  button.

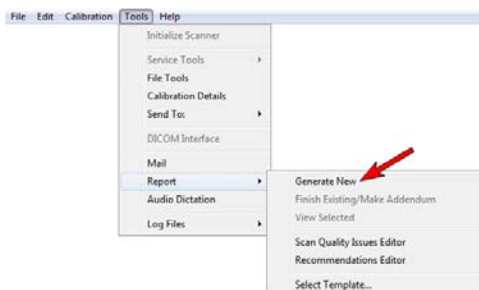

5. The Report is immediately generated and opens up in the window, as shown. At this point, the operator can type in their comments and recommendations, *Lock* it, *Save* it, *Print* it, *Export* it to a PDF file (or a DICOM file) and *Close* it.

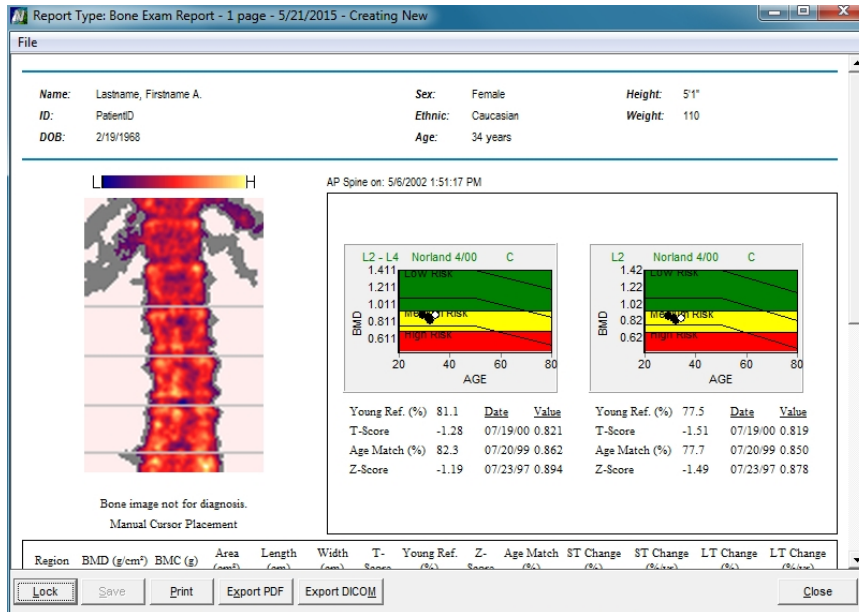

6. Click . The "Print" window appears. Select a printer, select which pages to print and choose how many copies to print.
7. Click to print the Report. The Report is automatically saved and printed.
8. Click .
9. You are returned to the Filmstrip view screen. The saved Report can be found under the "Reports" tab. The Report can be viewed, modified and reprinted at any time. See "The "Reports" Tab" on page 2-14 for more information.

A Sample Bone Exam Report

A sample 2-page Bone Exam Report is included here for reference.

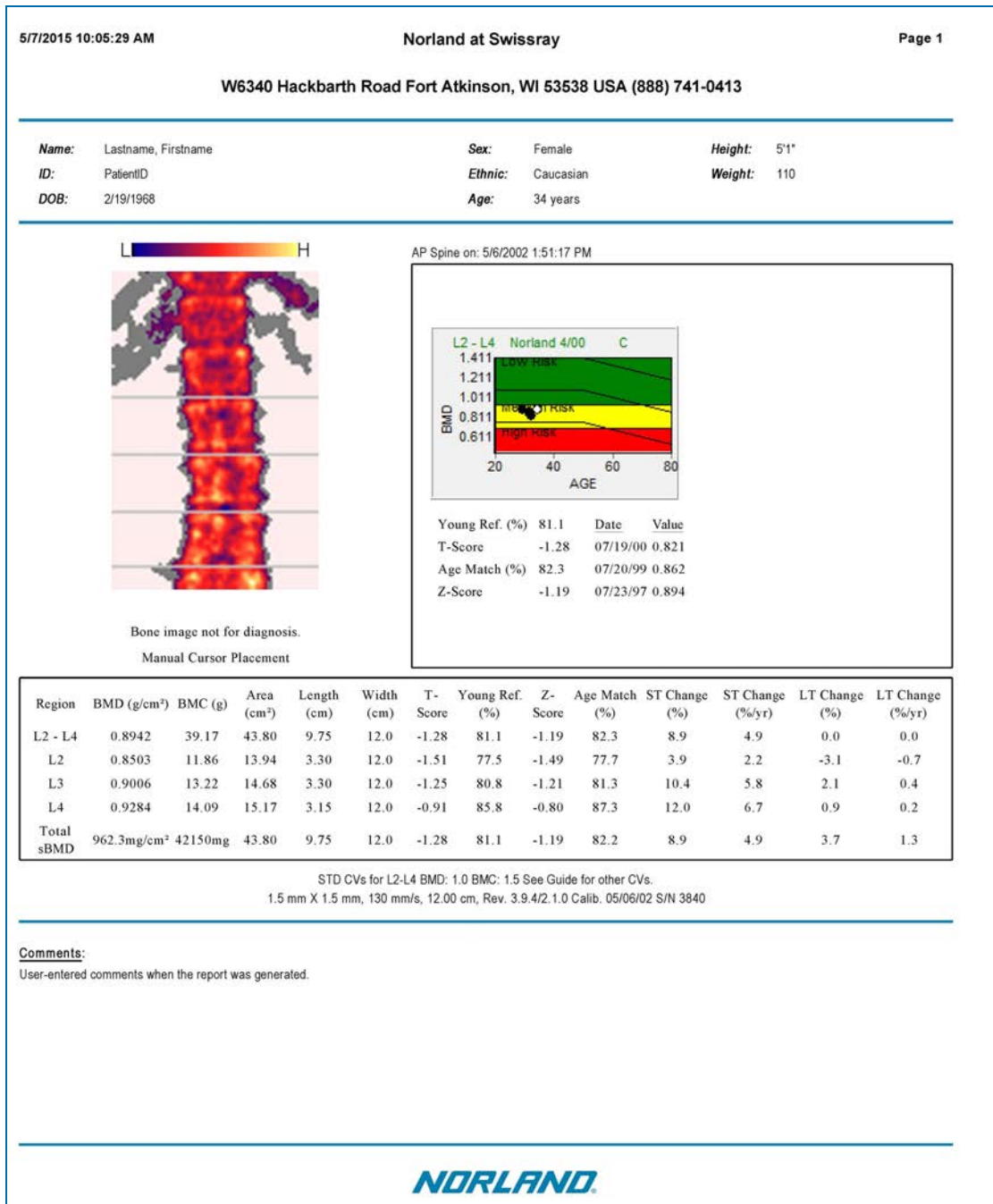

Figure 7-4: Page 1 of the Bone Exam Report

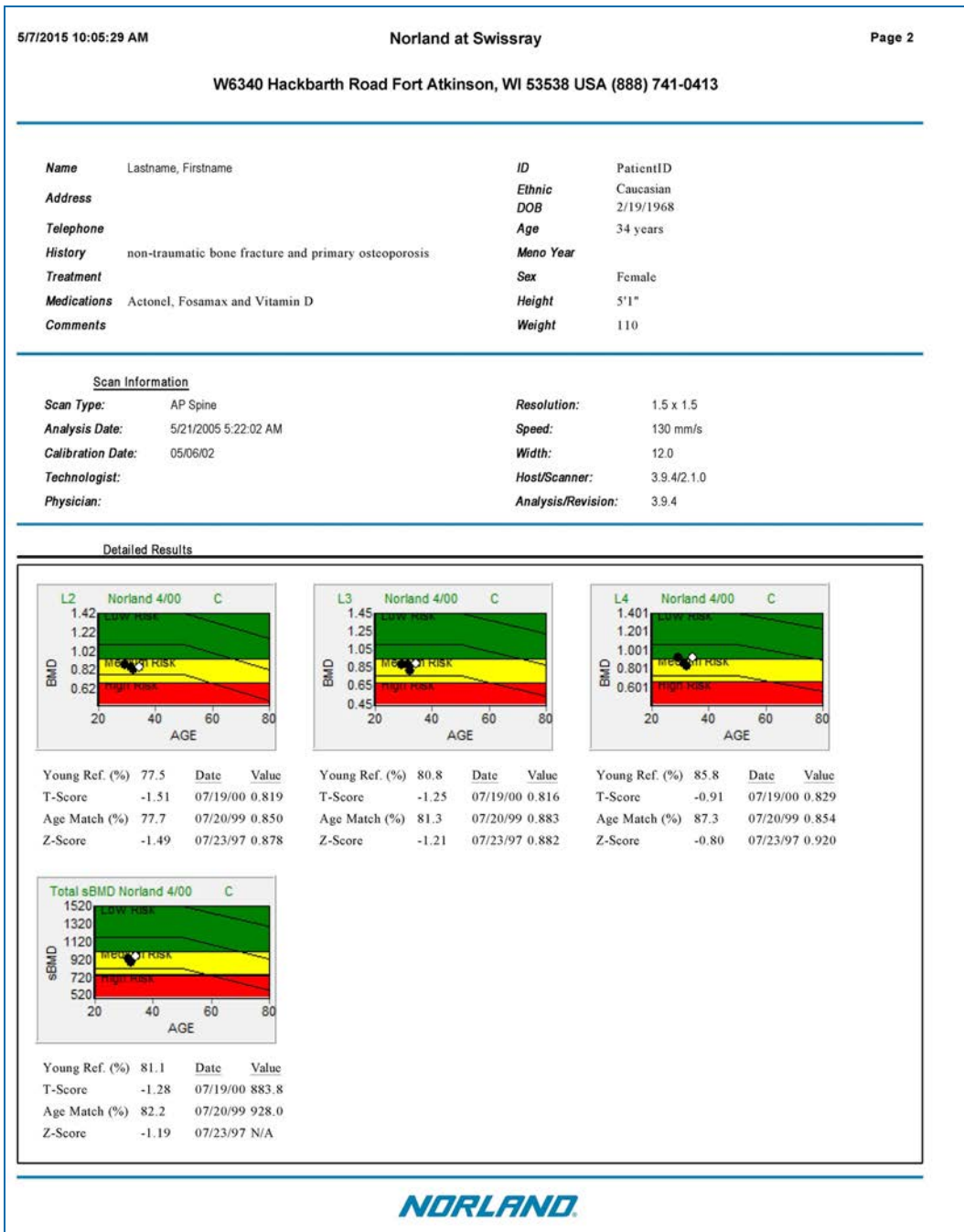

Figure 7-5: Page 2 of the Bone Exam Report

This page intentionally left blank.

CHAPTER 8

Scanning Hip

The Hip Scan procedure estimates bone mineral in the Femoral Neck, Greater Trochanter, and Ward's Triangle regions of the left or right hip. Estimates for Total Hip and sBMD Hip are also available.

The process begins with a Scout scan of the hip area. The scan should start above the neck of the femur and extend far enough down the femur so that the femoral neck is in the analysis area. The operator identifies the center of the femoral neck on the scout scan image, then the Measure scan is taken.



Figure 8-1: Patient Positioning for the Hip Scan

This chapter discusses the following.

Scan Specifications	8-2
Maintaining High Quality Hip Scans	8-4
General Patient Scanning Cautions	8-5
Quick Reference - Hip Scan	8-6
Scan Procedures	8-7
Analyzing the Scan	8-23
Viewing the Scan Results Tab	8-26
Generate and Print a Report	8-29
A Sample Bone Exam Report	8-31

Scan Specifications

Detailed specifications for the Hip scan are in the following tables.

Table 8-1: Detailed Hip Scan Specifications

Scan Sites	Femoral neck, Greater Trochanter, Ward's Triangle, Total Hip
Accuracy ^a	Typically within 1.0% of industry standard
In vivo Precision ^b	See table below
Scan Time	Refer to Technical Reference Section
Scout Scan Resolution	1.0mm x 4.0mm: Point resolution x line spacing (pixel size)
Measure Scan Resolution	1.0mm x 1.0mm: Point resolution x line spacing (pixel size)
Scan Speed	Selectable: High Precision - 45mm/sec Standard - 90mm/sec

Table 8-2: Hip Scan In vivo Precision

Measure Scan Mode	Measure Scan Speed	Femoral Neck C.V.			Greater Trochanter C.V.			Total
		BMD	BMC	AREA	BMD	BMC	AREA	BMD
Standard Speed	90mm/sec	1.5%	1.6%	1.0%	1.1%	2.0%	1.4%	0.7%
*** All specifications are subject to change without notice. ***								

^aBased on Standard Speed scans of an anthropomorphic phantom.

^bBased on scans of 14 subjects, 3 scans each, using standard procedure, scout and measure scan speed of 180mm/sec, scout scan resolution of 1mm x 4mm, and measure scan resolution of 1mm x 1mm.

Patient Dose



Note: The radiation dose to the patient is dependent on the type of scan procedure and the body thickness of the patient. The table below lists typical entrance skin dosages for the Hip Scout scan and Measure scan based on the listed body thickness.

Table 8-3: Scout Scan Skin Entrance Dose

Patient Thickness (cm)	Entrance Dose (μSv)
0-7	0.1
8-10	0.2
11-13	0.2
14-16	0.3
17-19	0.5
20-22	0.9
23-25	1.7
>25	2.6

Table 8-4: Measure Scan Skin Entrance Dose

Patient Thickness (cm)	High Precision (μSv)	Standard (μSv)
0-7	1.7	0.9
8-10	2.4	1.2
11-13	3.6	1.8
14-16	4.4	2.2
17-19	8.4	4.2
20-22	14.2	7.1
23-25	26.4	13.2
>25	41.1	20.6

Operator Dose



Note: The dose to the operator is negligible. During a scan, the radiation level at a distance of one meter from the scanner table is less than 1.0 microsieverts per hour.

Maintaining High Quality Hip Scans

Patient positioning, scan and analysis techniques can influence the precision and accuracy of Norland Bone Density estimations. Facilities can reduce the adverse effects of some of these factors by:

- » Performing and monitoring the daily QA procedure to verify that other radiation sources (x-ray machines, nuclear imagers) are not affecting the performance of the Norland system. The daily QA procedure verifies proper operation as well.
- » Ensuring that all operators position patients and analyze data in the same manner.
- » Screening patients for recent radionuclide uptake procedures. Residual emission may be misinterpreted by the Norland system as x-rays.
- » Screening patients for recent ingestion of radiopaque substances. Barium or other dyes used in some x-ray procedures could result in increased soft tissue x-ray absorption.
- » Screening patients for external opaque (metal and plastic) objects. Jewelry, buttons, zippers, rivets, buckles, pens, keys etc. can affect the results if they are in the scanning region.
- » Screening patients for prosthetic devices, implants, buttock augmentation, surgical staples, or other high density sub-dermal materials that may affect density estimates.
- » Ensuring that scan and analysis parameters remain constant for all scans of the same patient.
- » Always allowing the Hip Measure Scan to complete without interaction.
- » Ensuring the patient does not move during the scan.

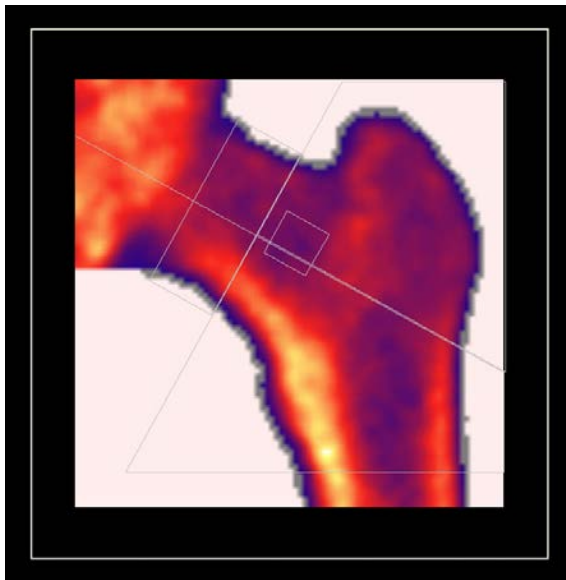

Figure 8-2: Example of a Good Quality Hip Scan

- » The femoral neck cursor should be a 1.5-cm horizontal slice of femoral neck, centered on axis, and should not include any other anatomy.
- » The scan includes the entire Greater Trochanter, shows the Lesser Trochanter and some of the femoral shaft.
- » The Lesser Trochanter is minimized in the region of interest, indicating proper rotation.
- » The Femoral shaft is straight, indicating proper abduction.

General Patient Scanning Cautions



Caution: Properly Mark the Patient. To ensure scanner arm does not contact the patient, always verify patient is positioned properly before scanning or moving the scanner arm.



Caution: Do not move the patient while marking the regions to be scanned. Always remain near the patient, in the event assistance is needed.



Caution: Do not touch the patient and the computer system at the same time as this could increase leakage currents.



Caution: Do not reach around to the back of the unit while the scanner arm is moving. While guards are provided, it is wise to avoid any chance of pinching the arm, hand, or fingers between the scanner arm and the frame, or between the source and the scanner arm.



Caution: Do not allow the patient to bump, push, or lean on the scanner arm. Manually moving the arm could result in an error message which will require removing the patient from the table and doing the Find Table Dimensions routine.



Caution: Make certain the patient does not dangle their arm or hand over the riser while the scanner arm is moving during a scan. The scan will not be usable, as the patient will not be properly positioned, and the patient may be at risk of pinching their hand or finger between the scanner arm and the riser or between the x-ray source and the scanner arm.



Caution: Make certain the patient does not stick a finger into the slot in the bottom of the upper arm cover during a scan; it could be pinched.



Caution: When positioning the patient, ensure they start by sitting near the center of the table and then swing their legs up. Sitting at either end makes positioning awkward.







Caution: Caution the patient to remain still during the scan to ensure quality results.



Caution: Help the patient up from the scanner after scan data collection; some patients may require a few minutes to regain equilibrium after lying down for a length of time.

Quick Reference - Hip Scan

The Hip scan process consists of a brief Scout scan over the femoral neck area, a Measure scan, calculation of numeric results, and the saving and printing of data.

- » Screen patient for contraindications.
- » In the Database Navigator window, click on the *existing* patient's name, then click  OR click  to start a *new* record.
- » Update (or enter) the patient's Demographic information.
- » Click . Click the Right Hip or Left Hip button. Click . Check the parameters.
- » Position the patient face up in the center of the scanner table. Place the Hip Sling with straps under the patient's legs as close to the pelvic area as possible. Place the Leg Separator Block between the patient's heels.
- » Position and pull up on the Velcro strap (to remove any slack) on the leg that will not be scanned. Repeat the process on the leg that will be scanned.





Note: Scan the non-dominant side (except in the case of a previous fracture or prosthetic device).

- » On the leg that will not be scanned, gently pull the Velcro strap to the next reference number to rotate the hip. Repeat the process on the leg that will be scanned.







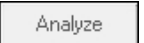

Caution: Caution the patient not to stare into the beam.

- » Click  in the Parameters tab window.
- » **MARKING THE CENTER OF THE FEMORAL NECK:** Position the scanner arm over the patient's mid-section. Turn ON the laser and position the laser dot at the approximate center of the femoral neck. Press the  button on the Scanner Arm Touch Pad.
- » Click  to begin the Scout Scan.

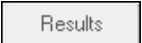

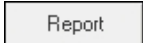
Note: The Scout Scan may be terminated when the entire femoral neck is visible. A minimum of 10 scout scan lines must be completed.

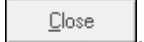
- » When the Scout scan is finished, click on the target and drag it to the center of the femoral neck.
- » Click on . Allow the Measure scan to complete.
- » If the scan is satisfactory, click .
- » If no further scans are to be performed, remove the Hip Sling and assist the patient up from table.
- » Click on the target, drag it to the center of the femoral neck, click .
- » Click . Click . Click  to print a Report.
- » Click  and then .

Scan Procedures

Checklist

You are almost ready to begin scanning. Confirm that the following tasks have been completed:

- » the system is running (see "Powering Up the System " on page 4-3)
- » the System Calibrations are done (see "Daily Calibration Procedure" on page 4-6)
- » the Database Navigator window is open (Figure 4-3: on page 4-5)

Preparing the Patient for Scanning

Ensure that the patient has removed all items from their pockets and that clothing is free of metal (i.e. rivets, buttons, zippers) or anything else that might be of a high density. It might be necessary to have the patient change to an examination gown or robe. Shoes should also be removed.

Update (or Create) the Patient's Record

EXISTING PATIENT: From the Database Navigator window, double-click on the existing patient's name to open the patient's record. Update the patient's information. (If necessary, refer to "Enter Data into the Existing Patient's Record" on page 4-24 for instructions.)

You are now ready to begin the scan process.

Proceed with "Setting the Scan Parameters" on page 7-8 to continue.

NEW PATIENT: From the Database Navigator window, click on to start a new record. Enter all the patient information. (If necessary, refer to "Preparing Patient Records" on page 4-21 for instructions.)

You are now ready to begin the scan process.

Proceed with "Setting the Scan Parameters" on page 7-8 to continue.

Setting the Scan Parameters

The photos used in these procedures are for a **left hip** scan. However these instructions are easily applied to a right hip scan by adopting a mirror image of the patient positioning photos.

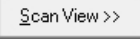
1. Click .
2. Click Left Hip (or Right Hip) in the pop-up window.

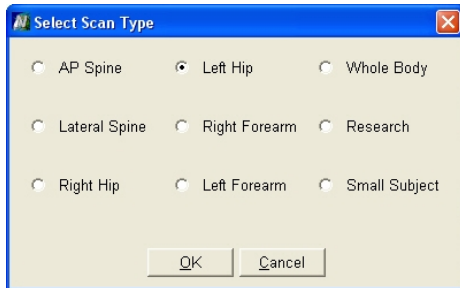

3. Click .
4. The Parameters tab window opens.

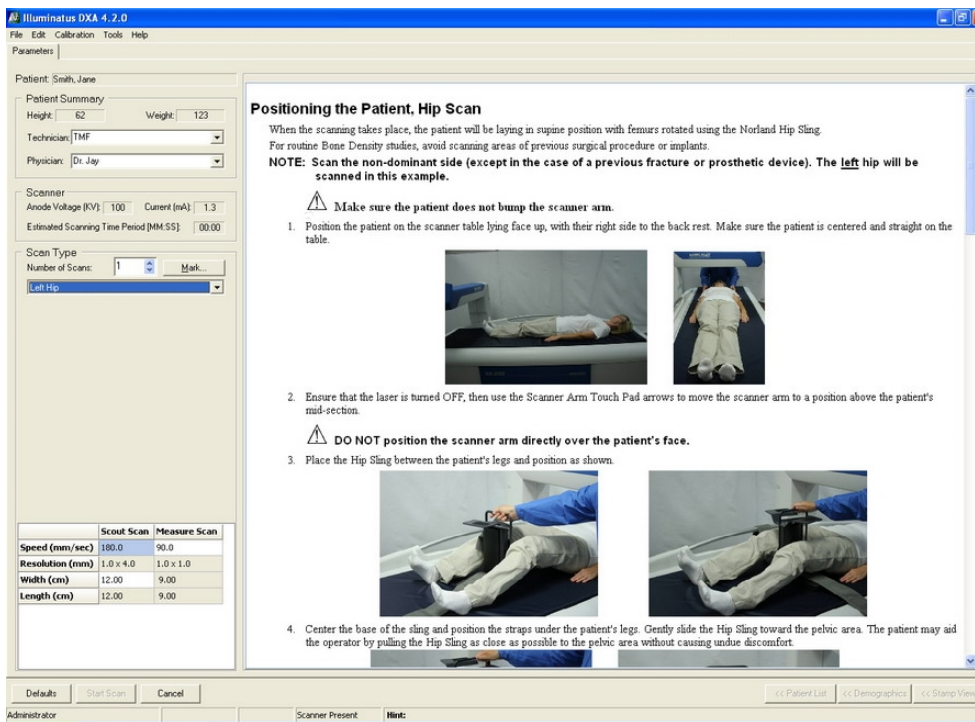

Figure 8-3: The Hip Scan Parameters tab window

5. The scan parameters are shown in the bottom left hand side of the Parameters tab window, and reproduced here for reference. Norland recommends that the factory default parameter settings be used for scanning. The default values are shown below.

	Scout Scan	Measure Scan
Speed (mm/sec)	180.0	90.0
Resolution (mm)	1.0 x 4.0	1.0 x 1.0
Width (cm)	12.00	9.00
Length (cm)	12	9

- » To reset values to factory defaults, see "Preferences: Hip Scan" on page 3-25.
 - » For a full explanation of the Hip Scan parameters (i.e. preferences) see "Preferences: Hip Scan" on page 3-25.
 - » If it is necessary to change the *Speed* or *Width* parameters, see "Changing the Scan Parameters Prior to Scanning" on page 11-69.
6. Change the number of multiple scans of the same subject only when scanning phantoms.
 7. Proceed to "Positioning the Patient" on the next page to continue.

Positioning the Patient

When the scanning takes place, the patient will be lying in supine position with femurs rotated using the Norland Hip Sling.

For routine Bone Density studies, avoid scanning areas of previous surgical procedures or implants.



Note: Scan the non-dominant side (except in the case of a previous fracture or prosthetic device). The left hip will be scanned in this example.

Refer to the patient positioning photos and instructions in the Norland software (in the Parameters tab window). The steps and photos are reprinted in the manual for reference.



Positioning the Patient. Hip Scan

When the scanning takes place, the patient will be lying in supine position with femurs rotated using the Norland Hip Sling. For routine Bone Density studies, avoid scanning areas of previous surgical procedure or implants.



NOTE: Scan the non-dominant side (except in the case of a previous fracture or prosthetic device). The left hip will be scanned in this example.

⚠ Make sure the patient does not bump the scanner arm.

1. Position the patient on the scanner table lying face up, with their right side to the back rest. Make sure the patient is centered and straight on the table.

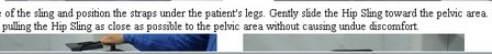

2. Ensure that the laser is turned OFF, then use the Scanner Arm Touch Pad arrows to move the scanner arm to a position above the patient's mid-section.

⚠ DO NOT position the scanner arm directly over the patient's face.
3. Place the Hip Sling between the patient's legs and position as shown.

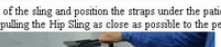
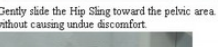

4. Center the base of the sling and position the straps under the patient's legs. Gently slide the Hip Sling toward the pelvic area. The patient may aid the operator by pulling the Hip Sling as close as possible to the pelvic area without causing undue discomfort.





	Scout Scan	Measure Scan
Speed (mm/sec)	180.0	90.0
Resolution (mm)	1.0 x 4.0	1.0 x 1.0
Width (cm)	12.00	9.00
Length (cm)	12.00	9.00

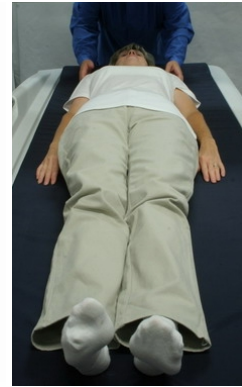

Caution: Make sure the patient does not bump the scanner arm.

1. Position the patient on the scanner table laying face up with their right side to the back rest. Make sure the patient is centered and straight on the table. Ensure that the patient's hips, spine, and shoulders are straight.



2.  Ensure that the laser is turned OFF, then use the Scanner Arm Touch Pad arrows to move the scanner arm to a position above the patient's mid-section.



 **Caution:** DO NOT position the scanner arm directly over the patient's face

3. Place the Hip Sling between the patient's legs and position as shown.



 **Note:** If the patient's legs are too large to fit in the hip sling, it may be omitted. Continue to "The patient is now ready for scanning." on page 8-15.



Note: To maintain consistent patient positioning, the hip sling should be used on all patients whenever possible.

- Center the base of the sling and position the straps under the patient's legs. Gently slide the Hip Sling toward the pelvic area. The patient may aid the operator by pulling the Hip Sling as close as possible to the pelvic area without causing undue discomfort.



- Spread the patients feet and place the Leg Separator Block between the heels.



Note: For the next step, instruct the patient to relax their legs. It is important that the rotation of the leg is a direct result of using the hip sling and not due to the patient rotating the leg in an effort to help the operator.

- Position the leg that will not be scanned in the fixture (patient's right leg in this photo). Put the leg strap in the slot, then pull up on it to remove any slack. Hold the strap taut but do not rotate the leg.



7. Locate the Velcro on the top of the fixture. Fold the strap down to secure it to the Velcro.



8. Position the other leg in the fixture and pull up on the leg strap to remove any slack. Hold the strap taut but do not rotate the leg. Then secure the strap to the Velcro on top of the fixture.



9. Notice that each Velcro strap is marked in increments consisting of letters and numbers (A 1-7, B 1-7, etc.). On the leg that will not be scanned (right leg, in this example), note the letter-number combination on the edge of the strap that is closest to the reference line on the fixture (B 4 in this example).

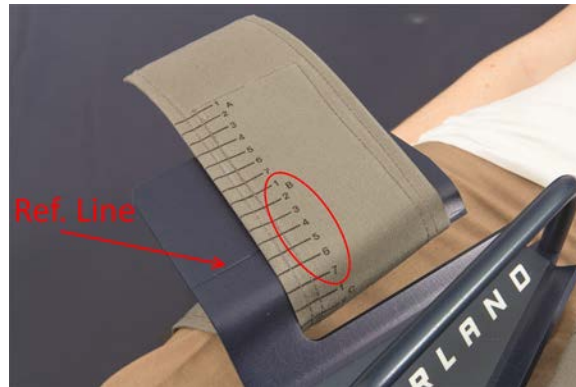

10. Grasp the top of the Hip Sling with one hand and pull the strap gently with the other hand. While pulling gently on the strap, the patient's leg should begin to rotate almost immediately. If it does not, **start over**.



11. When done properly, the strap will be free of slack. The patient must not "help" rotate the femur. If they do, improper and inconsistent positioning may result.
12. Lift and pull the strap to rotate the leg a total of seven (7) marked increments on the strap (if initially at B-1, pull to C-1). Secure the strap to the Velcro pad on top of the fixture.



13. Repeat the process on the other leg. Remember, if the patient's leg does not begin to rotate almost immediately, start over.



14. Position the patient's hands at their sides or over the chest to ensure that they will not be in the scan field.



15. The patient is now ready for scanning.
16. Make the patient as comfortable as possible since movement during the scan will affect the results. The use of a sheet or light blanket will not interfere with the scan results. The use of a pillow under the head is recommended.

Marking the Scan Region

1. Click in the Parameters window to open the dialog box.



2. Locate the approximate center of the femoral neck on the patient.
3. For assistance in locating the femoral neck, refer to Figure 8-4: below and Table 8-5: "Three methods to locate the center of the Femoral Neck" on the facing page.



Note: FOR CLARIFICATION: The typical default settings of the left and right hip Scout Scan regions are shown below. Each scan region is centered around the recommended MARK point. The asterisk * in the figure corresponds to the location of the recommended Mark point at the center of the femoral neck.

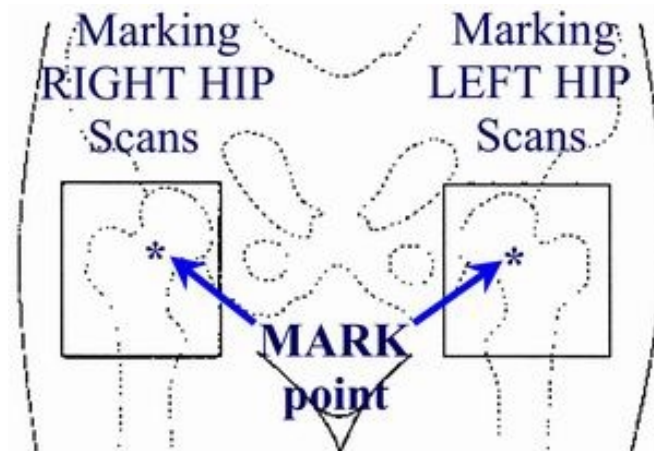
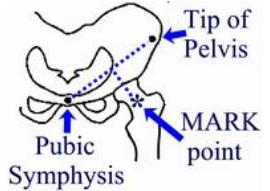
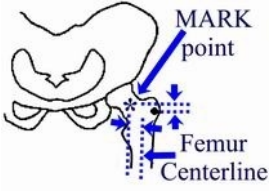
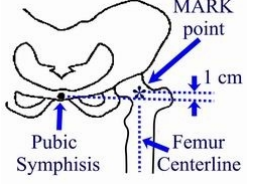





Figure 8-4: Approximate Center of the Femoral Neck

Table 8-5: Three methods to locate the center of the Femoral Neck

<p>Pelvis tip and pubic symphysis</p>	<p>Locate the tip of the pelvis (anterior superior) and the pubic symphysis. Place the laser positioning dot perpendicular to the midpoint of this line and about 4" (10cm) out from the line.</p>	
<p>Greater Trochanter</p>	<p>Locate the Greater Trochanter and position the laser positioning dot on a point several centimeters above the trochanter, and several centimeters from the centerline of the femur (anterior superior).</p>	
<p>Pubic symphysis</p>	<p>Imagine a transverse line across the pubic symphysis. Imagine another line down the center of the femur. Place the laser positioning dot 1cm above the intersection of these two lines.</p>	

 **Caution:** Caution the patient not to stare into the beam.

4. Press  to turn the laser ON.
5. **MARKING THE FEMORAL NECK:** Place the laser positioning dot on the center of the femoral neck and press . (The computer will emit a sound, and the laser will flash.)



6. The dialog box will automatically close.

Starting the Scout Scan

Once the center of the femoral neck has been marked, the *Start Scan* button in the Parameters tab window will become available to the operator. Caution the patient to remain still.



Remember, press the Emergency Stop button directly below the Scanner Arm Touch Pad to immediately terminate the x-ray exposure or stop the scanner arm movement. Refer to "Pressing the Emergency Stop Button" on page 11-37 for instructions on safely resuming the scan.

1. Click .
2. The Scan tab window displays the image as it develops, shows how many lines will be scanned and gives an estimate of the total time remaining in the Scout scan.

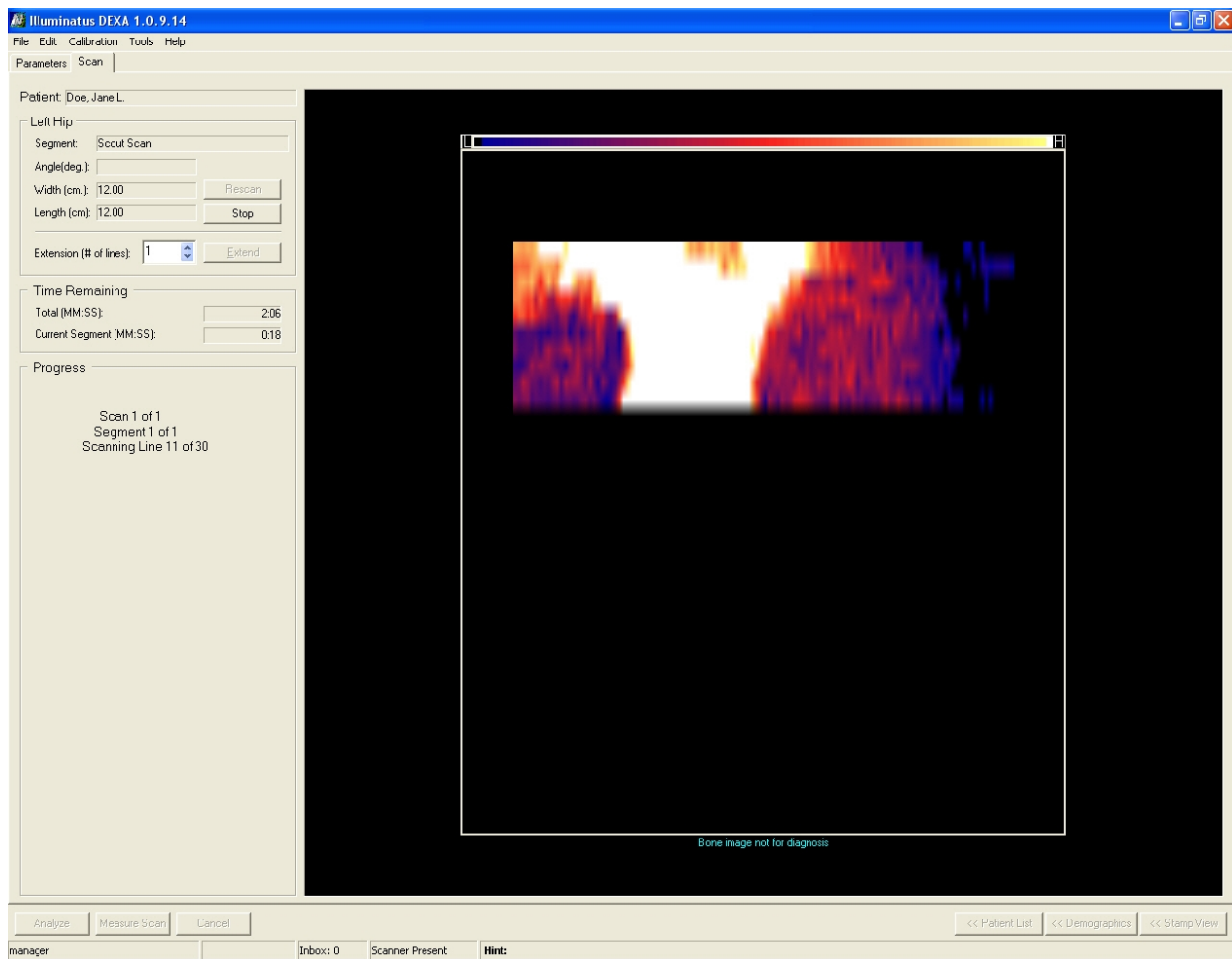

3. Monitor the image closely for any indication of patient movement. Cancel the scan immediately if the patient moves during the scan.

 **Note:** To cancel the scan: Click . Click .

Select in the dialog box. Click .

Click . Click . Select Left Hip or Right Hip.

Return to "Marking the Scan Region" on page 8-16 to continue.

- When the Scout Scan is complete, the computer will emit a sound. The software will update the Scan tab window and the *Measure Scan* button will become available.

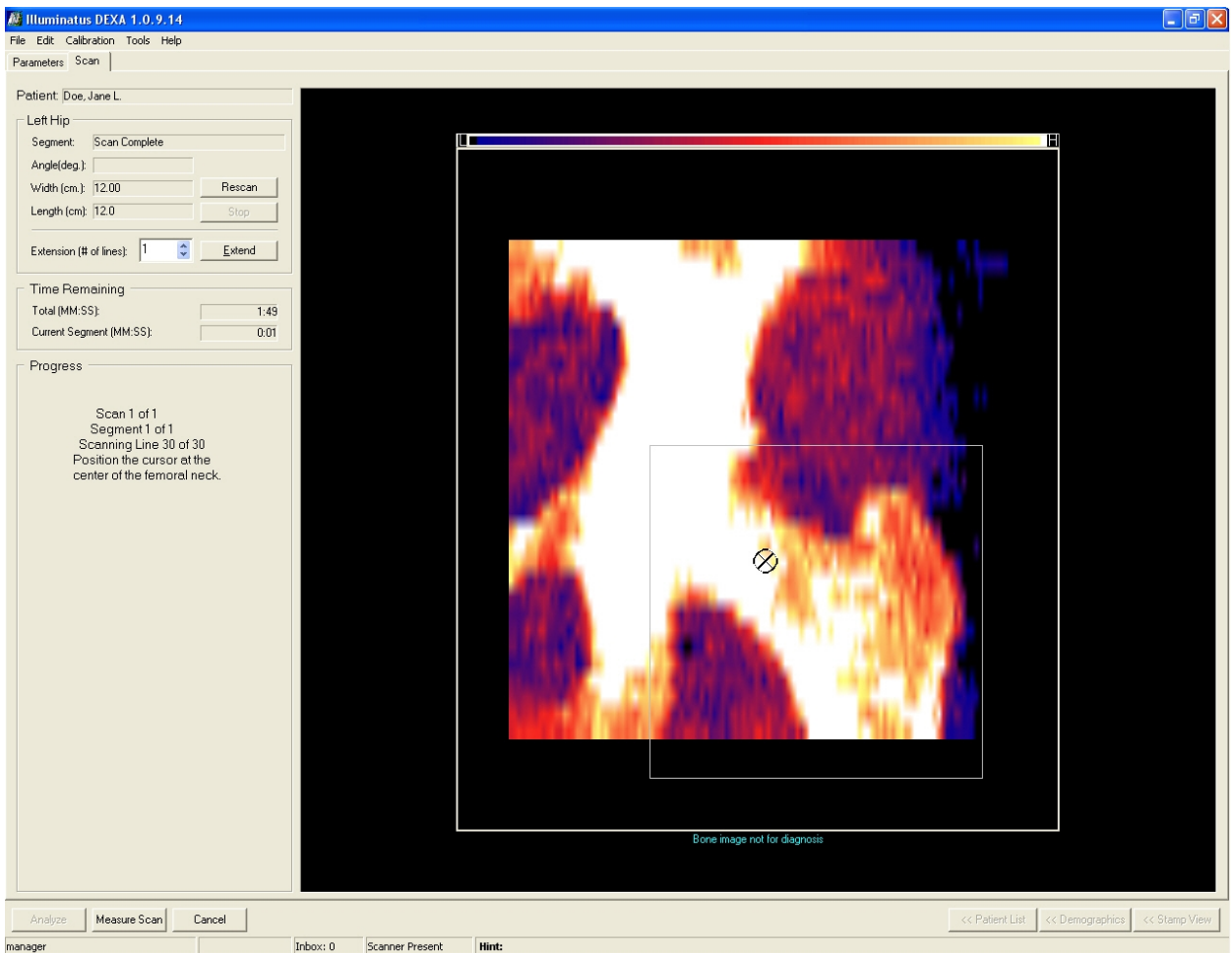

- Determine whether the quality of the Scout Scan image is satisfactory or unsatisfactory.
- THE SCOUT SCAN IMAGE IS SATISFACTORY** when the scanned area includes the entire Femoral Neck, the entire Greater Trochanter, part of the femoral shaft and the ilium. Proceed to **step 8**.
- THE SCOUT SCAN IMAGE IS UNSATISFACTORY** when the region of interest does not fit inside the cursor box. Proceed to the steps in "Unsatisfactory Scout Scan (Hip)" on page 11-70 for instructions.

8. To set the initial position of the region of interest (ROI), imagine a line across the femoral neck, as shown below, and locate the center.
9. Click on the target in the Scan window, drag it to the middle of the femoral neck, and release the mouse button to deposit the cursor.

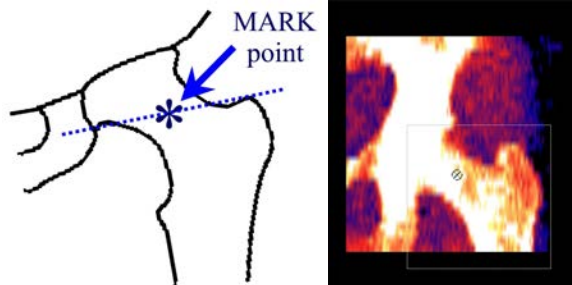

Starting the Measure Scan

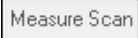

Remember, press the Emergency Stop button  directly below the Scanner Arm Touch Pad to immediately terminate the x-ray exposure or stop the scanner arm movement. Refer to "Pressing the Emergency Stop Button" on page 11-37 for instructions on safely resuming the scan.

1. Click on .
2. The Scan tab window displays the image as it develops, shows how many lines will be scanned and gives an estimate of the total time remaining in the Measure scan.

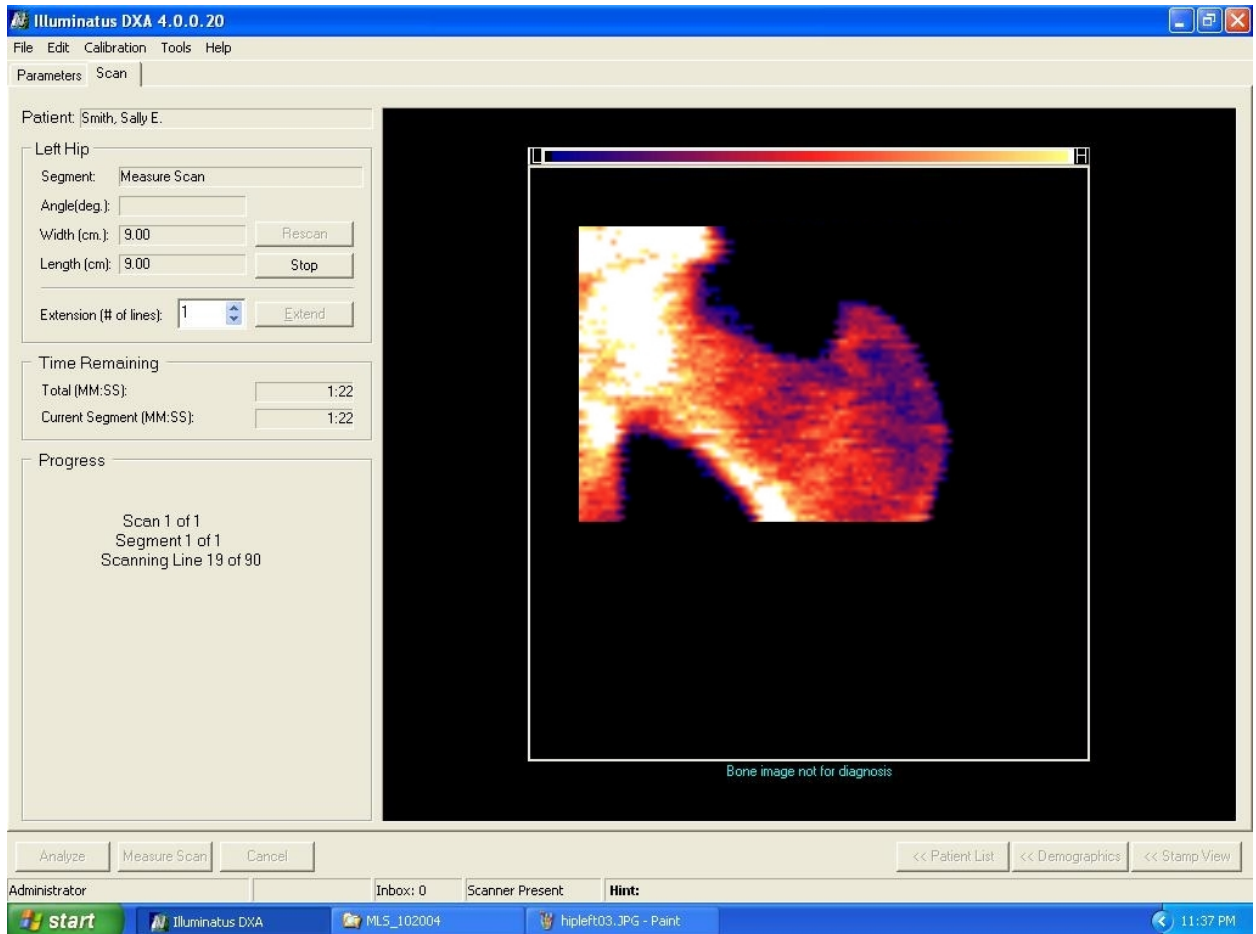

Note: Always allow the Measure Scan to complete without interruption. This will ensure that the region of interest is the same from scan to scan and will ensure the best precision.

3. Monitor the image closely for any indication of patient movement. Cancel the scan immediately if the patient moves during the scan.

 **Note:** To cancel the scan: Click . Click .

Select in the dialog box. Click .

Click . Click . Select Left Hip or Right Hip.

Return to "Marking the Scan Region" on page 8-16 to continue.

- When the Measure Scan is complete, the computer will emit a sound. The software will update the Scan tab window and the *Analyze* button will become available.

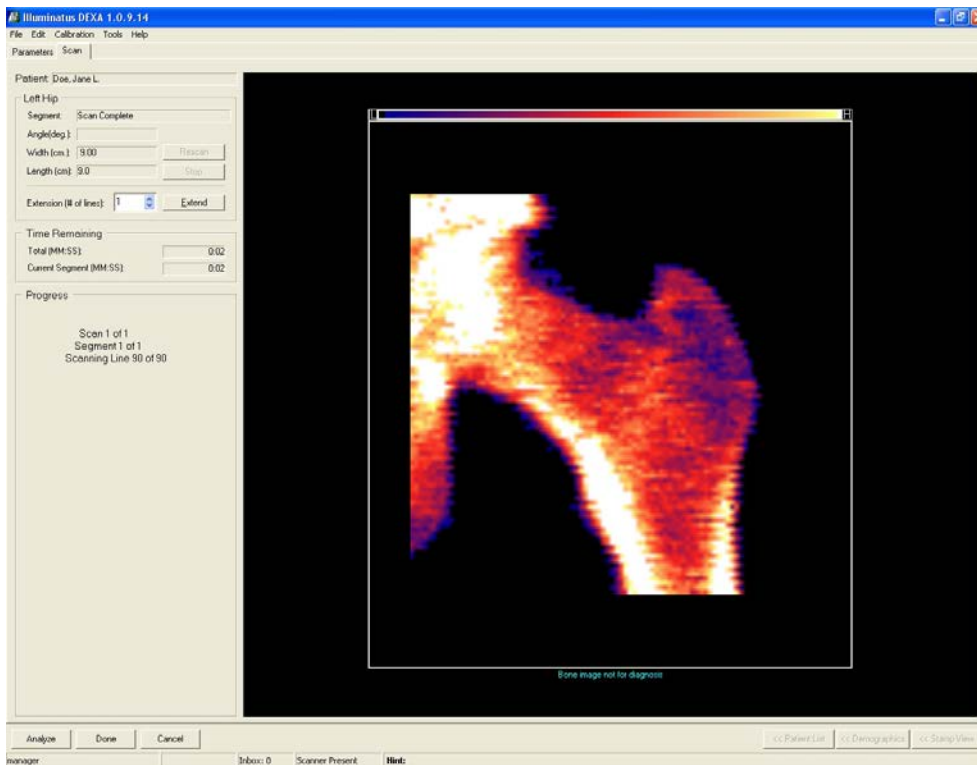

- If no further scans are to be performed, remove the Hip Sling from the patient and help the patient up from the scanner table. Make sure the scanner arm will not impede the patient's ability to sit up.

 **Caution:** Remember that some patients may require a few minutes to regain equilibrium after lying down for a length of time.

Analyzing the Scan

At this point, the operator can analyze the scan later, or analyze the scan now.

ANALYZE LATER: Click to end the scan process and analyze the scan later. The scan data will be saved to the database for analysis at a later time. The software will go back to the Parameter tab window. You can do another type of scan, if desired.

OR ANALYZE NOW . . .

1. Click .
2. When the Analysis tab window opens, a target cursor will be placed in the region of interest.

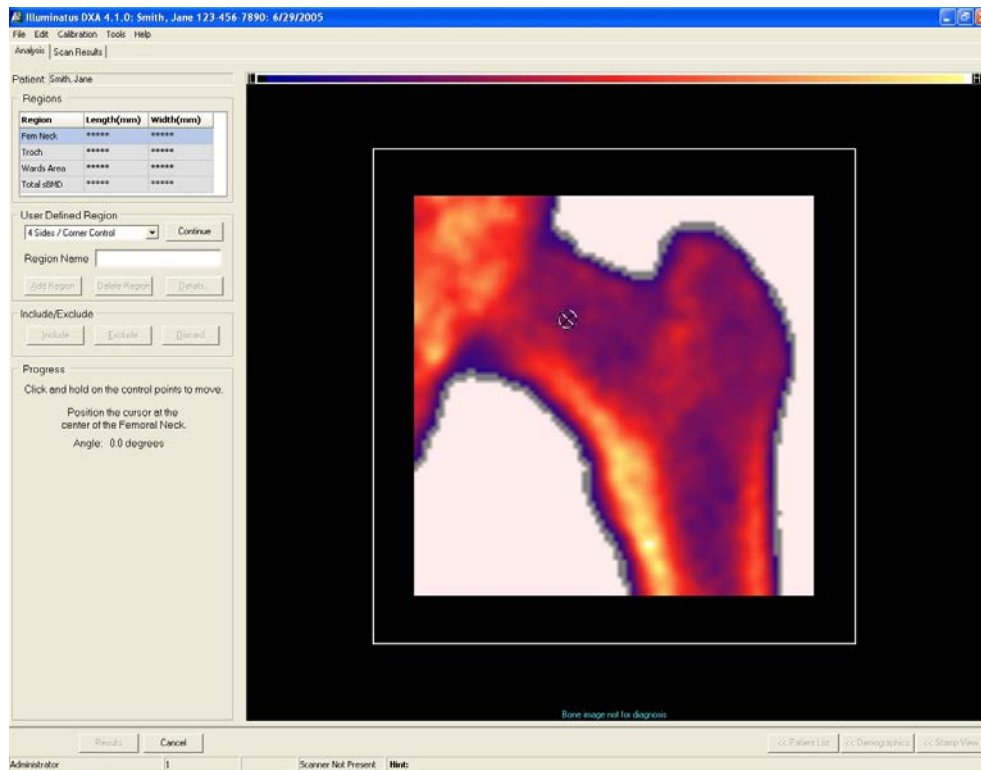

3. Using the click and drag method, position the target cursor on the mid-point of the femoral neck and release the mouse button to deposit it.

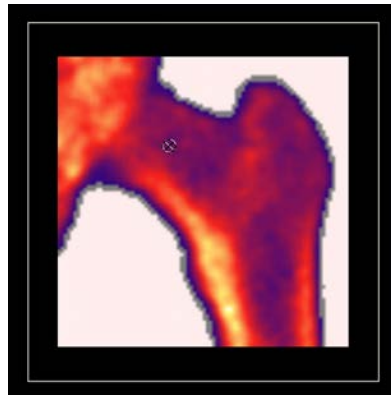

4. Click . If the automatic computer analysis is successful, the software will construct a cursor box and the Results button will become available.

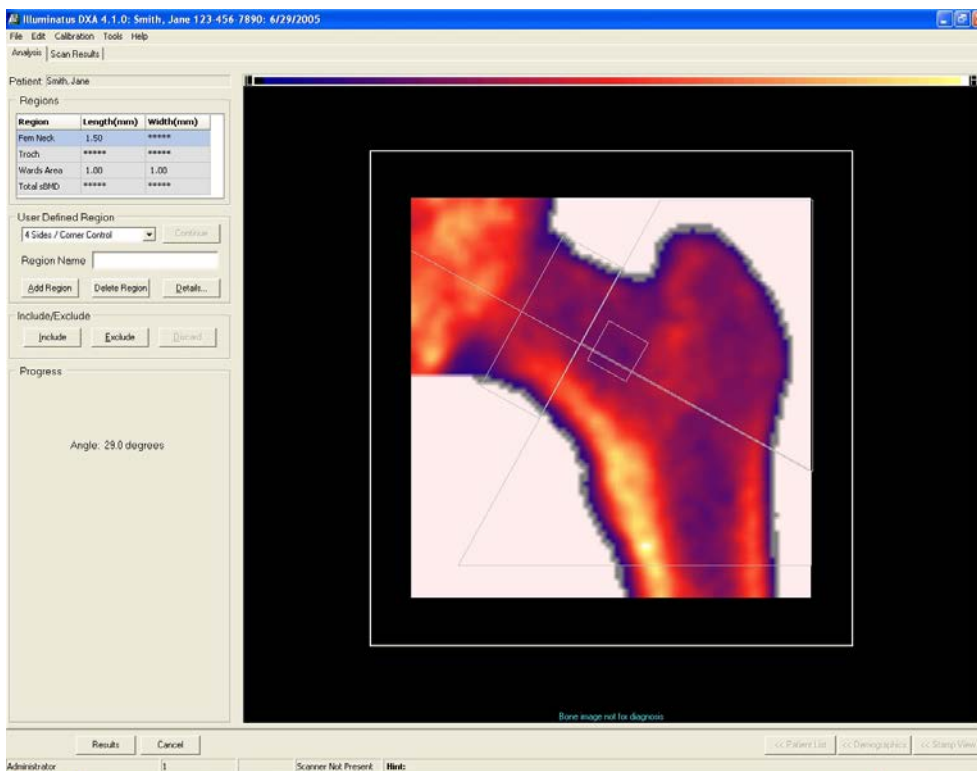

Note: Norland strongly recommends using the computer-generated analysis unless the regions of interest are blatantly incorrect.

5. If the patient has a prior scan, use the Show Comparison feature to aid in positioning the cursors in a consistent fashion. Right-click on the image, select **Image Analysis > Show Comparison**. (See "Comparison Image" on page 11-54).
6. If the software cannot automatically find the regions, the following dialog box will be displayed. Click

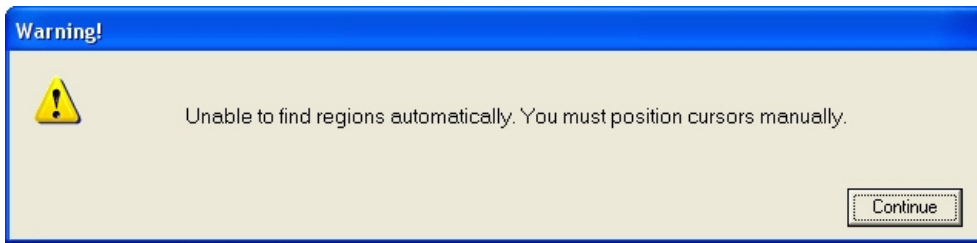

7. The region of interest cursors become available for adjustments.

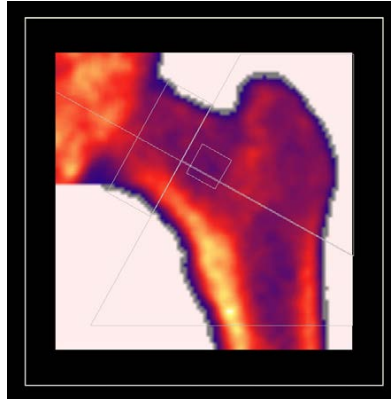

8. Click and hold on control points to set the regions of interest.
- » Click and drag from anywhere within the cursor box to drag the cursor group to the new position. Center the axis line through the femoral neck.
 - » The side cursors should be adjusted to include all of the neck. The neck cursor box should include only the neck. It should not include any other bone. Reposition the side cursors by using the pointer to click on a control point. Drag the cursor to its new location.
 - » The neck cursor box should enclose the narrowest part of the neck. To adjust the length of the femoral neck cursor box, use the pointer to click on one of the control points of the box that are on the centerline axis. Drag it along the centerline to adjust the length. Ideal length is 1.5-cm (or longest length possible).
 - » Align the centerline by clicking on the centerline control point and angulate to attain a horizontal slice of femoral neck.



Note: If it is not possible to attain either a 1.5cm or 1.0cm femoral neck length without including the pelvis, adjust the cursors to a maximum femoral neck length.

Viewing the Scan Results Tab

1. Click . The Scan Results tab window opens.

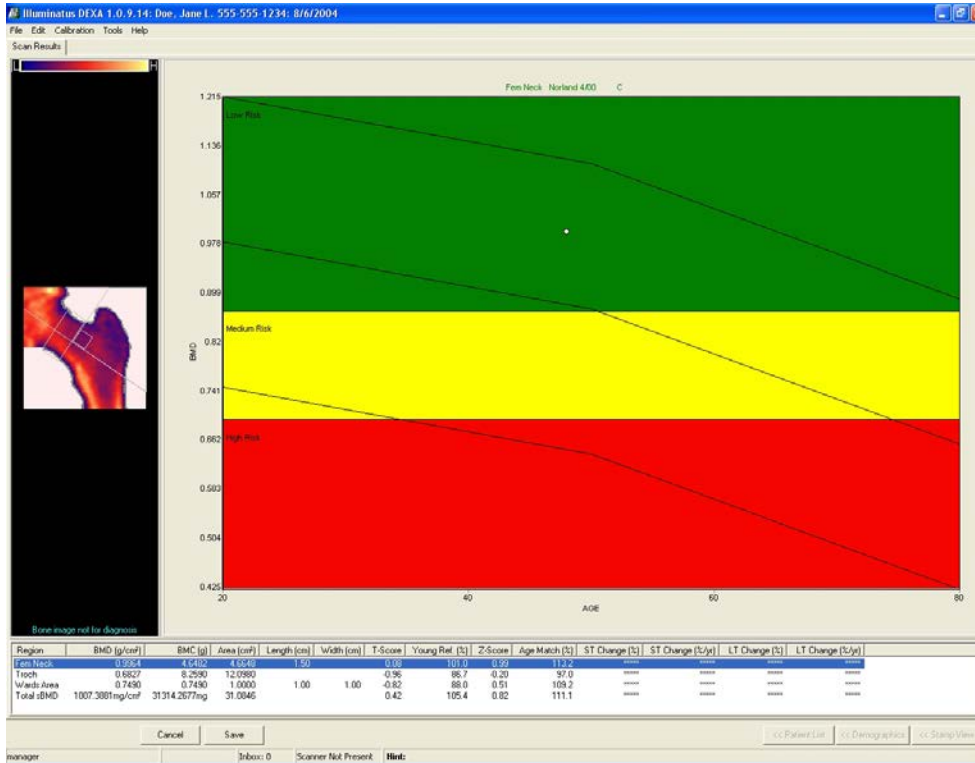

Note: Review in baseline mode is strongly recommended to determine if “Alternate R-Value Analysis” is necessary. Refer to the “Alternate R-Value Analysis” on page 11-71 of the Additional Techniques section for detailed instructions.

2. Click .
 - » The image thumbnail, trending or reference population graphs, and a results table are displayed in the Scan Results tab. (NOTE: image is not for diagnostic purposes.)
 - » If an exact match of the installed Reference Sets and the ethnic background (entered into the Patient Demographics window) does not exist, the Scan Results tab window will be displayed without a reference population graph.
 - » The BMD for the femoral neck will be plotted in the reference chart as a dot and the results will be displayed below the graph.
 - » The BMD, BMC, Area, Length, Width, T-Score, Young Ref %, Z-Score, and Age Match % for each region of interest are displayed.
 - » If the patient has been scanned before, % Short Term and % Long Term will be displayed.

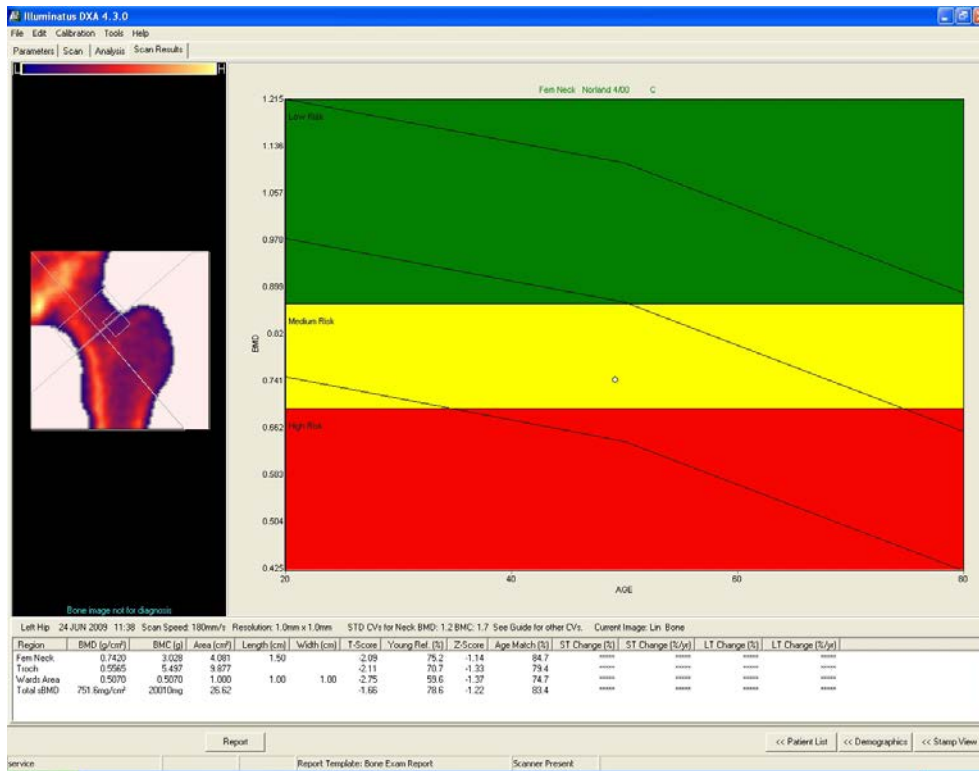

- » Click to generate and print a report using the current default report template. Proceed to Step 5 of "Generate and Print a Report" on page 7-24.
- » or click to generate and print a report using a report template other than the default. Proceed to "Generate and Print a Report" on page 7-24.
- » or click to do another scan.
- » or click to end the process and return to the main window.

Definitions of Scan Results

Table 8-6: Definition of Scan Results

T-SCORE	The T-score is the number of standard deviations a patient's BMD value is above or below a young reference value for individuals of same ethnic background and gender.
% YOUNG REFERENCE	The % Young reference value is the ratio of the patient's bone mass to the young reference value for individuals of same ethnic background and gender.
Z-SCORE	The Z-score is the number of standard deviations that the patient's BMD value is above or below the reference value for individuals of same age, ethnic background and gender.
% AGE-MATCHED	The % Age-matched value is the ratio of the patient's bone mass to the reference bone mass value of individuals of the same age, ethnic background and gender.
% ST: SHORT TERM CHANGE	Ratio of change between current scan and most recent previous scan.
% LT: LONG TERM CHANGE	Ratio of change between current scan and patient's initial scan.
%/YR value	Indicates the percent of ST or LT change calculated per year.

Fracture Risk Assessment

The patient's risk of fracture is plotted in the Reference Charts displayed in the Scan Results tab window. Norland incorporates the WHO (World Health Organization) criteria in plotting a patient's fracture risk assessment. See table below. (Note that this table is re-reprinted here for reference.)

Table 8-7: WHO Criteria: Fracture Risk Assessment

Low Risk (Green)	Represents the range of values determined by WHO to be 'normal' (having adequate bone mineral). The BMD T-Score values in this region are within 1 SD of the young adult reference mean value. A patient whose value is plotted in this region has no identifiable risk of fracture.
Medium Risk (Yellow)	Represents the range of values determined by WHO to be 'osteopenic' (having low bone mineral). The BMD T-Score values in this region range are more than 1 SD below the young adult mean value but less than 2.5 SD below the mean value. A patient whose value is plotted in this region may be developing a tendency to fracture.
High Risk (Red)	Represents the range of values determined by WHO to be 'osteoporotic' (having severely reduced bone mineral). The BMD T-Score values in this region are more than 2.5 SD below the young adult mean. A patient whose value is plotted in this region has a high spontaneous fracture probability.

Generate and Print a Report

Six different types of Reports can be generated for each scan: the *Bone Exam Report*, the *Bone Exam Report - 1 Page*, the *Combined Report*, the *Patient Letter*, the *Referral Letter*, and the *Ten Year Fracture Risk Report*. When saved, these reports become part of the scan data.

These procedures use the *Bone Exam Report - 1 Page* for the example.

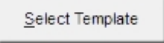
1. Make sure that the scanned image is being viewed as a thumbnail in the **Stamp View** or the **Filmstrip View**. Click (to highlight) the thumbnail view of the scan.
2. Click **Tools > Report > Select Template...** or click the  button to open the "Report Configuration" dialog box.

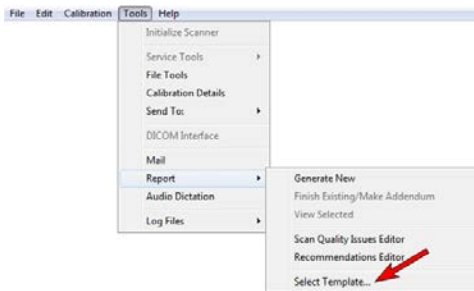

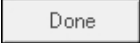
3. When the **Report Configuration** dialog box opens, click a Report Template to highlight it (*Bone Exam Report - 1 Page* was selected here). See "Sample Scan Reports" on page 2-17 for examples of the report template selections. Click .

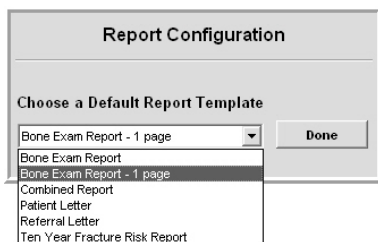

 **Note:** The selected Report Template will remain the default until it is changed. The currently selected Report Template is always displayed at the bottom of the IlluminatusDXA window.

4. Click **Tools > Report > Generate New** or click the  button.

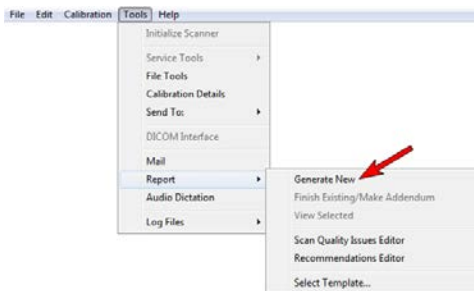

5. The Report is immediately generated and opens up in the window, as shown. At this point, the operator can type in their comments and recommendations, *Lock* it, *Save* it, *Print* it, *Export* it to a PDF file (or a DICOM file) and *Close* it.

Report Type: Bone Exam Report - 6/28/2006 - Creating New

Name: Smith, Jane Ethnic: Caucasian
 AP: Left Hip Height: 62.5"
 Age: 65 years Weight: 156.8
 Sex: Female

Left Hip on: 6/28/2005

Bone image not for diagnosis.

Fem Neck: Norland 400 C
 1.215
 1.015
 0.815
 AGE

Young Ref. (%) 98.3
 T-Score -0.14
 Age Match (%) 127.5
 Z-Score 1.79

Region	BMD (g/cm ³)	BMC (g)	Area (cm ²)	Length (cm)	Width (cm)	T-Score	Young Ref. (%)	Z-Score	Age Match (%)	ST Change (%)	ST Change (%/yr)	LT Change (%)	LT Change (%/yr)
Fem Neck	0.9707	4.865	5.012	1.30		-0.14	98.3	1.79	127.5	*****	*****	*****	*****
Trach	0.8727	11.48	13.15			0.79	110.9	2.25	139.1	*****	*****	*****	*****
Wash Area	0.7556	0.7556	1.000	1.00	1.00	-0.76	88.8	1.61	136.2	*****	*****	*****	*****
Total BMD	1120mg/cm ²	39500mg	34.68			1.44	118.5	2.66	140.5	*****	*****	*****	*****

STD CVs for Neck BMD: 1.2 BMC: 1.7 See Guide for other CVs
 1.0 mm X 1.0 mm, 45 mm/s, 9.00 cm, Rev. 2.5.3/2.0.0 Calb. 05/25/05 S/N 8248

Comments:

Lock Save Print Export PDF Export DICOM Close

6. Click . The "Print" window appears. Select a printer, select which pages to print and choose how many copies to print.
7. Click to print the Report. The Report is automatically saved and printed.
8. Click .
9. You are returned to the Filmstrip view screen. The saved Report can be found under the "Reports" tab. The Report can be viewed, modified and reprinted at any time. See "The "Reports" Tab" on page 2-14 for more information.

A Sample Bone Exam Report

A sample 2-page Bone Exam Report is included here for reference.

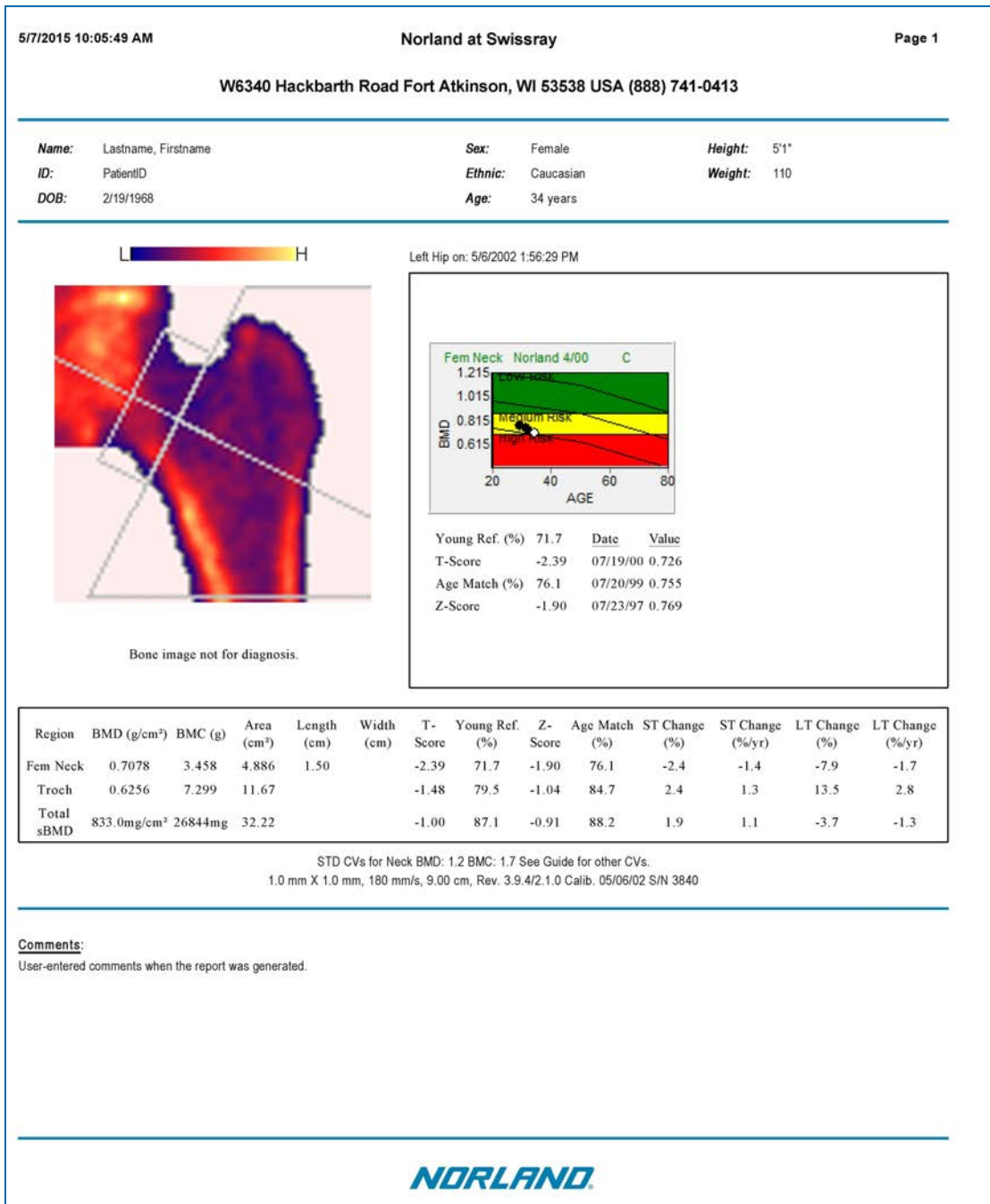

Figure 8-5: Page 1 of the Bone Exam Report

5/7/2015 10:05:49 AM
Norland at Swissray
Page 2

W6340 Hackbarth Road Fort Atkinson, WI 53538 USA (888) 741-0413

Name	Lastname, Firstname	ID	PatientID
Address		Ethnic	Caucasian
Telephone		DOB	2/19/1968
History	non-traumatic bone fracture and primary osteoporosis	Age	34 years
Treatment		Meno Year	
Medications	Actonel, Fosamax and Vitamin D	Sex	Female
Comments		Height	5'1"
		Weight	110

Scan Information

Scan Type: Left Hip	Resolution: 1.0 x 1.0
Analysis Date: 5/21/2005 5:21:51 AM	Speed: 180 mm/s
Calibration Date: 05/06/02	Width: 9.0
Technologist:	Host/Scanner: 3.9.4/2.1.0
Physician:	Analysis/Revision: 3.9.4

Detailed Results

Troch Norland 4/00 C

Total sBMD NHANES III C

Young Ref. (%)	Date	Value	Young Ref. (%)	Date	Value
T-Score	-1.48	07/19/00 0.611	T-Score	-1.00	07/19/00 817.4
Age Match (%)	84.7	07/20/99 0.640	Age Match (%)	88.2	07/20/99 865.4
Z-Score	-1.04	07/23/97 0.551	Z-Score	-0.91	07/23/97 N/A

Figure 8-6: Page 2 of the Bone Exam Report

CHAPTER 9

Research & Small Subject Scan



Note: The Research Scan and Small Subject Scan features are available as options with the Bone Densitometer. Be aware that your system might not have either of these options.

The Research Scan software quantifies bone mineral in any user-defined region of a patient or subject anywhere within the scanner's active scanning area. The subject of a Research scan could be human, animal, or an inanimate object. The Research Scan is typically used for animal scans, anything from excised bones to whole body large rats to implants.

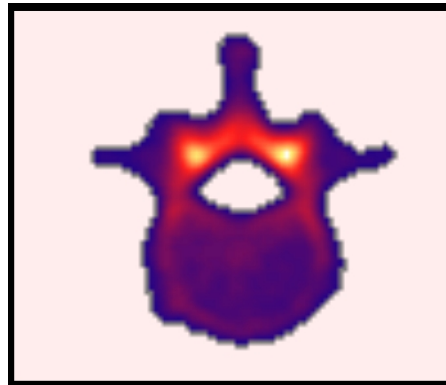

Figure 9-1: An example Research Scan image of the top view of a vertebra

This chapter discusses the following.

Introduction	9-2
Scan Specifications	9-2
Maintaining High Quality Research Scans	9-4
General Patient Scanning Cautions	9-5
Quick Reference Guide - Research/Small Subject	9-6
Scan Procedures	9-7
Analyzing the Scan	9-16
Viewing the Scan Results Tab	9-18
Generate and Print a Report	9-20
A Sample Bone Exam Report - 1 Page	9-22

Introduction

The Research scan consists of a Measure scan over an area defined by the operator. An optional Scout scan is available to assist the operator in defining the scan region. Analysis is performed on the scan data using operator-defined regions of interest and numeric results are calculated and displayed.

The operator has the capability of adjusting the start and end points of the Scout and Measure scans. Other adjustable parameters are the scan speed, scan resolution, and scan width.

Scan Specifications

Detailed specifications for the Research and Small Subject scans are in the following tables.

Table 9-1: Research/Small Subject Scan Specifications

Scan Site	Any operator-defined region within the scanner Active Scanning Window
Scan Speed	1.0mm/sec to 260mm/sec
Scan Width	2 x selected pixel size up to maximum scan width
Scan Length	2 x selected pixel size up to maximum scan length
Spatial Resolution	See table below

Table 9-2: Research/Small Subject Scan Spatial Resolution

	Point Resolution x Line Spacing	
Scout Scan	1.0 x 1.0mm	1.5 x 1.5mm
	1.0 x 2.0mm	3.0 x 3.0mm
	1.0 x 3.0mm	6.0 x 6.0mm
Measure Scan	0.5 x 0.5mm	3.0 x 3.0mm
	1.0 x 1.0mm	6.0 x 6.0mm
	1.5 x 1.5mm	

Table 9-3: Bone Threshold Values

Bone Threshold is 0.125 g/cm ² for Research Scan
Bone Threshold is 0.04 g/cm ² for Small Subject Scan



Note: All specifications are subject to change without notice.

Patient Dose



Note: The radiation dose to the subject is dependent on the resolution, filtration, and the scan speed used. Dose values listed below are based on the default scan parameters.

Table 9-4: Scout Scan Skin Entrance Dose (μSv)
(60mm/sec at 3.0mm x 3.0mm resolution)

Subject Thickness (cm)	Entrance Dose (μSv)
0-3	0.4
4-6	0.6
7-9	0.9
10-12	1.2
13-15	2.2
16-18	3.7
19-21	6.9
>21	11.0

Table 9-5: Measure Scan Skin Entrance Dose (μSv)
(60mm/sec at 1.0mm x 1.0mm resolution)

Subject Thickness (cm)	Entrance Dose (μSv)
0-3	1.3
4-6	1.8
7-9	2.7
10-12	3.3
13-15	6.3
16-18	11.1
19-21	20.0
>21	31.0

Operator Dose



Note: The dose to the operator is negligible. During a scan, the radiation level at a distance of one meter from the scanner table is less than 1.0 microsieverts per hour.

Maintaining High Quality Research Scans

Variations in subject and positioning, scan and analysis techniques can influence the precision and accuracy of Bone Density estimations. Facilities can reduce the adverse effects of some of these factors by:

- » Performing and monitoring the daily QA procedure to verify that other radiation sources (x-ray machines, nuclear imagers) are not affecting the performance of the Norland system. The daily QA procedure verifies proper operation as well.
- » Ensuring that all operators position patients/subjects and analyze data in the same manner.
- » Screening patients/subjects for recent radionuclide uptake procedures. Residual emission may be misinterpreted by Norland Bone Densitometers as x-rays.
- » Screening patients/subjects for recent ingestion of radiopaque substances. Barium or other dyes used in some x-ray procedures could result in increased soft tissue x-ray absorption.
- » Screening patients/subjects for prosthetic devices, implants, surgical staples, or other high density subdermal materials that may affect bone density estimates.
- » Ensuring that patients/subjects contain no metal objects or other high density objects that might affect bone density estimations.
- » Ensuring that scan and analysis parameters remain constant for all scans of the same patient or subject.

General Patient Scanning Cautions



Caution: Properly Mark the Patient. To ensure scanner arm does not contact the patient, always verify patient is positioned properly before scanning or moving the scanner arm.



Caution: Do not move the patient while marking the regions to be scanned. Always remain near the patient, in the event assistance is needed.



Caution: Do not touch the patient and the computer system at the same time as this could increase leakage currents.



Caution: Do not reach around to the back of the unit while the scanner arm is moving. While guards are provided, it is wise to avoid any chance of pinching the arm, hand, or fingers between the scanner arm and the frame, or between the source and the scanner arm.



Caution: Do not allow the patient to bump, push, or lean on the scanner arm. Manually moving the arm could result in an error message which will require removing the patient from the table and doing the Find Table Dimensions routine.



Caution: Make certain the patient does not dangle their arm or hand over the riser while the scanner arm is moving during a scan. The scan will not be usable, as the patient will not be properly positioned, and the patient may be at risk of pinching their hand or finger between the scanner arm and the riser or between the x-ray source and the scanner arm.



Caution: Make certain the patient does not stick a finger into the slot in the bottom of the upper arm cover during a scan; it could be pinched.



Caution: When positioning the patient, ensure they start by sitting near the center of the table and then swing their legs up. Sitting at either end makes positioning awkward.







Caution: Caution the patient to remain still during the scan to ensure quality results.



Caution: Help the patient up from the scanner after scan data collection; some patients may require a few minutes to regain equilibrium after lying down for a length of time.











Quick Reference Guide - Research/Small Subject

The Research Scan feature quantifies bone mineral in any specially-defined region of a patient or subject anywhere within the scanner's active scanning area.

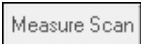
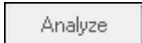
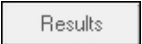
- » Screen patient for contraindications.
- » In the Database Navigator window, click on the *existing* patient's name, then click  OR click  to start a *new* record.
- » Update (or enter) the patient's Demographic information.
- » Click . Click the Research or Small Subject button. Click . Check the parameters.
- » Position the patient/subject on the table.

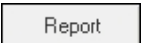

Caution: Caution the patient not to stare into the beam.

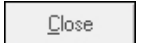
- » Click  in the Parameters tab window.
- » **MARKING THE START POINT:** Turn ON the laser. Position the laser dot at the start point and then press the  button on the Scanner Arm Touch Pad.
- » **MARKING THE END POINT:** Position the laser dot at the end point and press the  button.
- » **MARKING THE BASELINE POINT:** Position the scanner arm so that the laser positioning dot is over a point (within the start and end points) of maximum soft tissue (no bone). For objects which contain no soft tissue, take a baseline point in table adjacent to object. Press the  button.
- » Click  to perform the Scout Scan.
- » Use the click and drag method to move the cursor box to define the area to be measured.
- » Click on  and define the regions of interest.
- » If the scan is satisfactory, click .
- » Define the regions of interest with the **Special Regions** option.
- » Click .
- » Click .
- » Click  to print a Report (or click  to end the process and return to the main window).
- » Click ,  and then .

Scan Procedures

Checklist

You are almost ready to begin scanning. Confirm that the following tasks have been completed:

- » the system is running (see "Powering Up the System " on page 4-3)
- » the System Calibrations are done (see "Daily Calibration Procedure" on page 4-6)
- » the Database Navigator window is open (Figure 4-3: on page 4-5)

Preparing the Patient for Scanning

When performing a Research scan on a human patient, confirm that the patient has been prepared for scanning. Ensure that the patient has removed all items from pockets and that clothing is free of metal (i.e. rivets, buttons, zippers) or anything else that might be of a high density. It might be necessary to have the patient change to an examination gown or robe. Shoes should also be removed.

Patients/subjects should be checked for any metal or high-density objects in the region of interest (ROI) that would affect bone density estimations.

Update (or Create) the Patient's Record

EXISTING PATIENT: From the Database Navigator window, double-click on the existing patient's name to open the patient's record. Update the patient's information. (If necessary, refer to "Enter Data into the Existing Patient's Record" on page 4-24 for instructions.)

You are now ready to begin the scan process.

Proceed with "Setting the Scan Parameters" on page 7-8 to continue.

NEW PATIENT: From the Database Navigator window, click on  to start a new record. Enter all the patient information. (If necessary, refer to "Preparing Patient Records" on page 4-21 for instructions.)

You are now ready to begin the scan process.

Proceed with "Setting the Scan Parameters" on page 7-8 to continue.

Setting the Scan Parameters

Illuminatus software in Norland equipment can be fitted with Research and Small Subject Software that allows the operator to scan an operator selected region for bone, lean or fat tissue. Research and Small Subject Software differ from each other in bone edge detection software. Research Scan Software utilizes the same bone edge detection software as other software in DXA and is recommended for animals over two kilograms or human subjects over two years of age. Small Subject Software utilizes a fixed bone edge detection system that will trigger at a much lower level and is recommended for children under two years of age and for animals between two-hundred grams and two kilograms in weight. In most cases using Research and Small Subject Software in these settings will effectively locate bone containing points and allow effective assessment of bone, lean and fat tissue.

1. Click .
2. Click Research or Small Subject in the pop-up window.

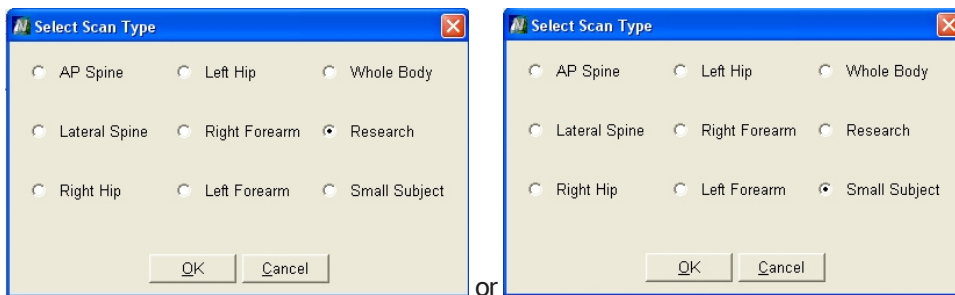

3. Click .
4. The Parameters tab window opens.

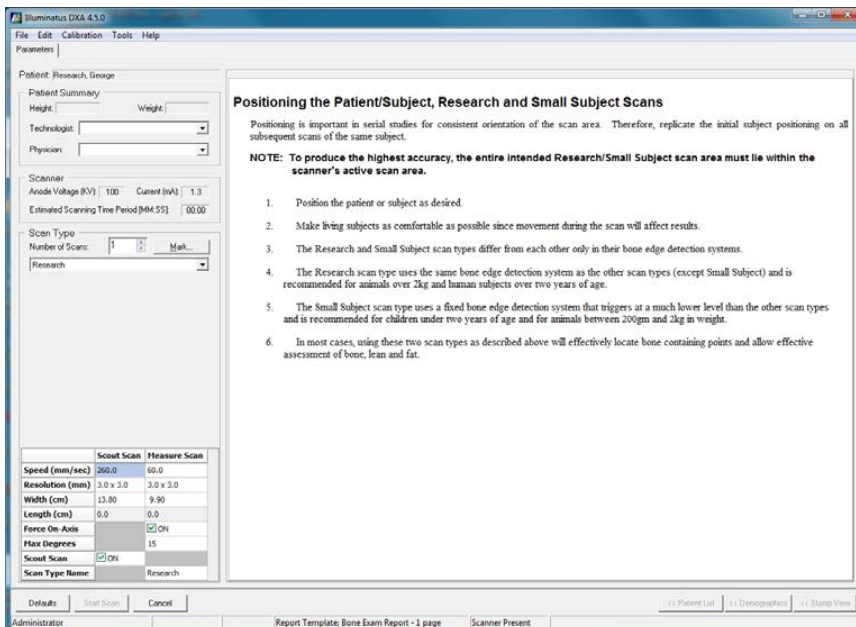

Figure 9-2: The Research Scan Parameters tab window

5. The scan parameters are shown in the bottom left hand side of the Parameters tab window, and reproduced here for reference. Norland recommends that the factory default parameter settings be used for scanning. The default values are shown below.

	Scout Scan	Measure Scan
Speed (mm/sec)	60.0	60.0
Resolution (mm)	3.0 x 3.0	1.0 x 1.0
Width (cm)	13.80	10.00
Length (cm)	0.0	0.0
Force On-Axis		<input checked="" type="checkbox"/> ON
Max Degrees		15
Scout Scan	<input checked="" type="checkbox"/> ON	
Scan Type Name		Research

- » To reset values to factory defaults, see "Preferences: Research/Small Subject Scan" on page 3-29.
 - » For a full explanation of the Research and Small Subject Scan parameters (i.e. preferences) see "Preferences: Research/Small Subject Scan" on page 3-29.
 - » If it is necessary to change any of the parameters, see "Changing the Scan Parameters Prior to Scanning" on page 11-78.
6. Proceed to "Positioning the Patient/Subject " on the next page to continue.

Positioning the Patient/Subject

Positioning is important in serial studies for consistent orientation of the scan area. Therefore, replicate the initial positioning on all subsequent scans of the same subject.



Note: To produce the highest accuracy, the entire intended Research/Small Subject scan area must lie within the scanner's active scan area.

Refer to the patient positioning photos and instructions in the Norland software (Parameters tab window). The steps and photos are reprinted in the manual for reference.

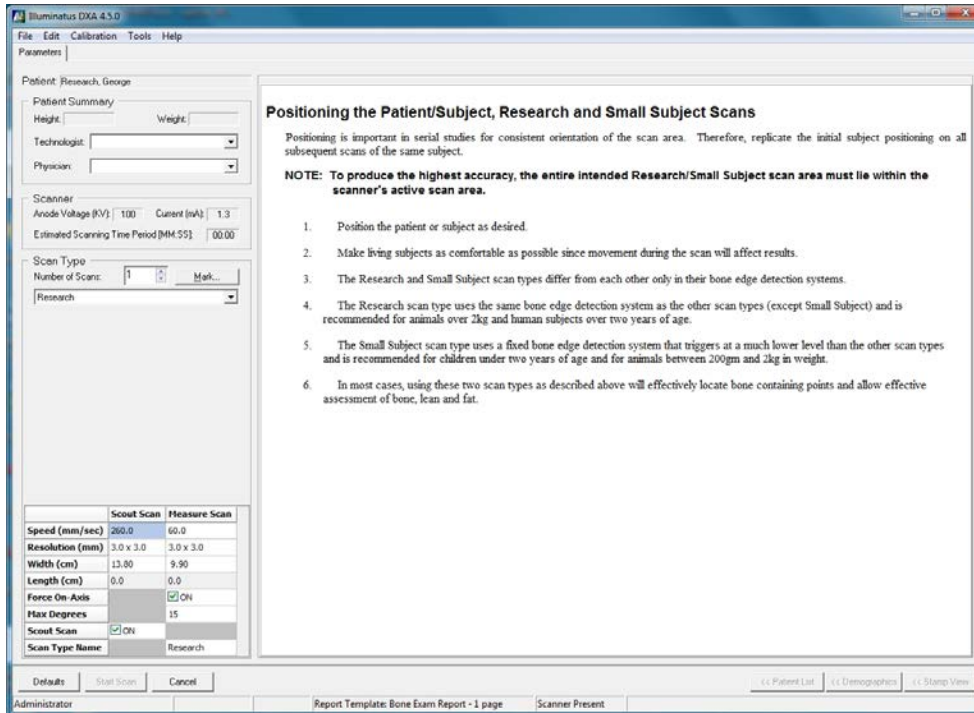

1. Position the patient or subject as desired.
2. Make living subjects as comfortable as possible since movement during the scan will affect the results.

Marking the Scan Region

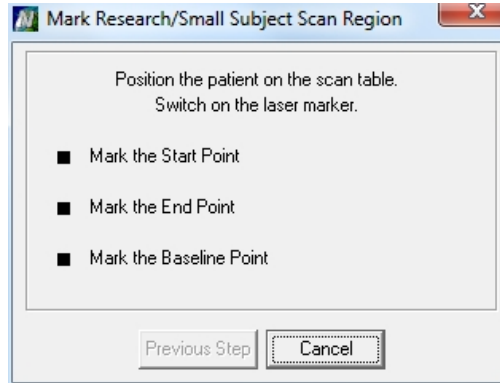

1. Click  in the Parameters tab window to open the dialog box.



Caution: Caution the patient not to stare into the beam.



2. Press  to turn the laser ON.

3. **MARKING THE START POINT:** Move the scanner arm to the start point and press . (The computer will emit a sound, and the laser will flash.)
4. **MARKING THE END POINT:** Move the scanner arm to the end point. Press the  button. (The computer will emit a sound, and the laser will flash.)
5. **MARKING THE BASELINE POINT:** Position the scanner arm so that the laser positioning dot is over a point (within the start and end points) of maximum soft tissue (no bone). For objects which contain no soft tissue, take a baseline point in the table adjacent to object. Press the  button. (The computer will emit a sound, and the laser will flash.)
 - » If the *Scout* scan was enabled, these points are the start and end points of the *Scout* scan.
 - » If the *Scout* scan was disabled, these are the start and end points of the *Measure* scan.
 - » The *Measure* scan may be defined by the operator at the Scan tab window upon completion of the Scout scan.
6. The dialog box will automatically close when the marking tasks are complete.

Starting the Scout Scan

If applicable, caution the patient to remain still.



Remember, press the Emergency Stop button directly below the Scanner Arm Touch Pad to immediately terminate the x-ray exposure or stop the scanner arm movement. Refer to "Pressing the Emergency Stop Button" on page 11-37 for instructions on safely resuming the scan.

1. Click .
2. The Scan tab window displays the image as it develops, shows how many lines will be scanned and gives an estimate of the total time remaining in the Scout scan.

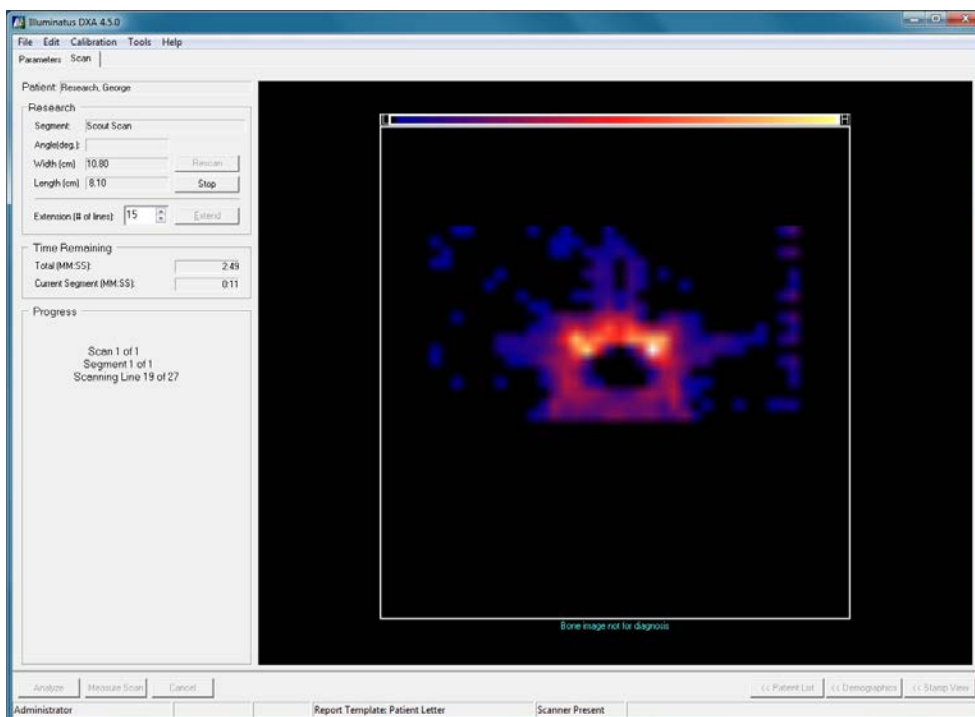

3. Monitor the image closely for any indication of patient movement. Cancel the scan immediately if the patient moves during the scan.



Note: To cancel the scan: Click . Click .

Select in the dialog box. Click .

Click . Click . Select Research or Small Subject.

Return to "Marking the Scan Region" on the previous page to continue.

- When the Scout Scan is complete, the computer will emit a sound. The software will update the Scan tab window and the *Measure Scan* button will become available.

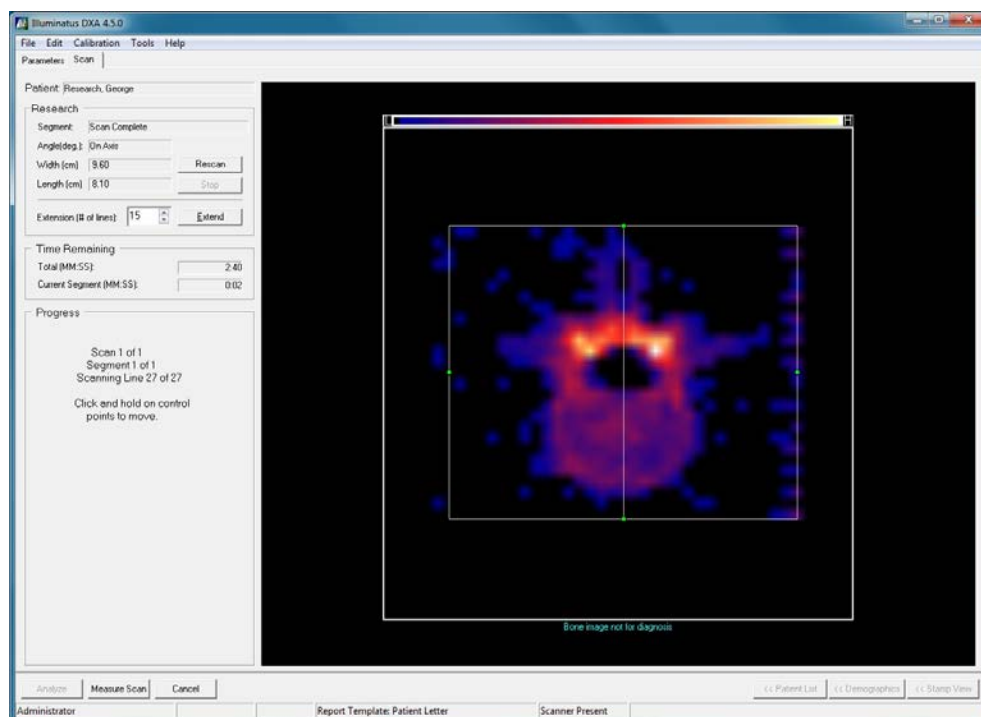

- Using the click and drag method, move the cursor box to define the area to be measured.
- If the Scout Scan image is **satisfactory**, proceed to "Starting the Measure Scan" on the next page to continue with the Measure Scan.

Starting the Measure Scan



Remember, press the Emergency Stop button directly below the Scanner Arm Touch Pad to immediately terminate the x-ray exposure or stop the scanner arm movement. Refer to "Pressing the Emergency Stop Button" on page 11-37 for instructions on safely resuming the scan.

1. Click on .
2. The Scan tab window displays the image as it develops, shows how many lines will be scanned and gives an estimate of the total time remaining in the Measure scan.

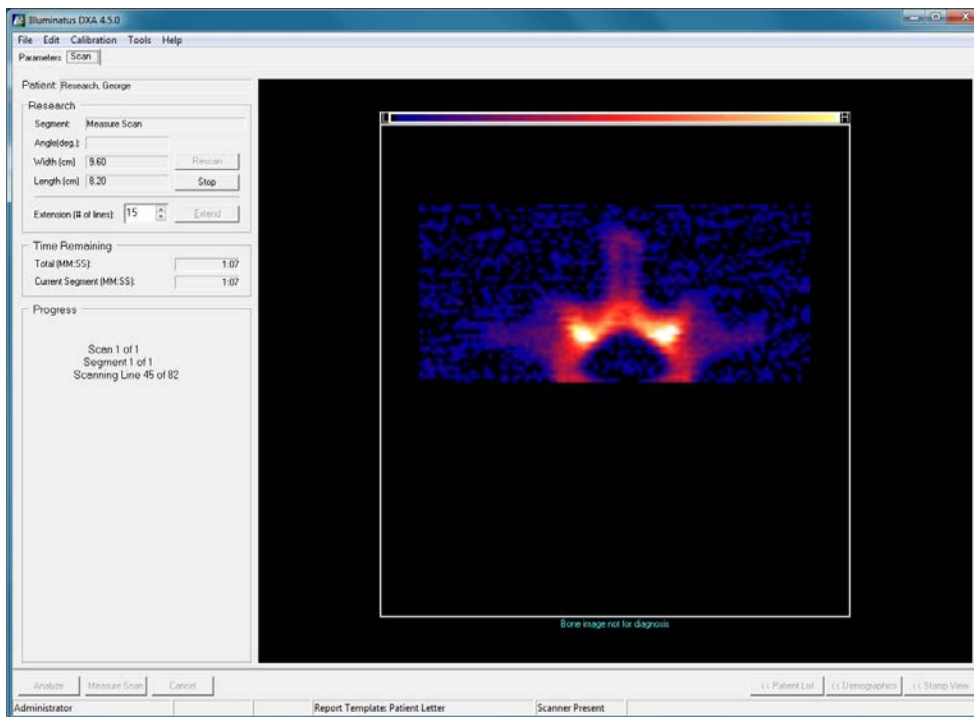

3. Monitor the image closely for any indication of patient movement. Cancel the scan immediately if the patient moves during the scan.



Note: To cancel the scan: Click . Click .

Select in the dialog box. Click .

Click . Click . Select Research or Small Subject.

Return to "Marking the Scan Region" on page 9-11 to continue.

4. When the Measure Scan is complete, the computer will emit a sound. The software will update the Scan tab window and the *Analyze* button will become available.

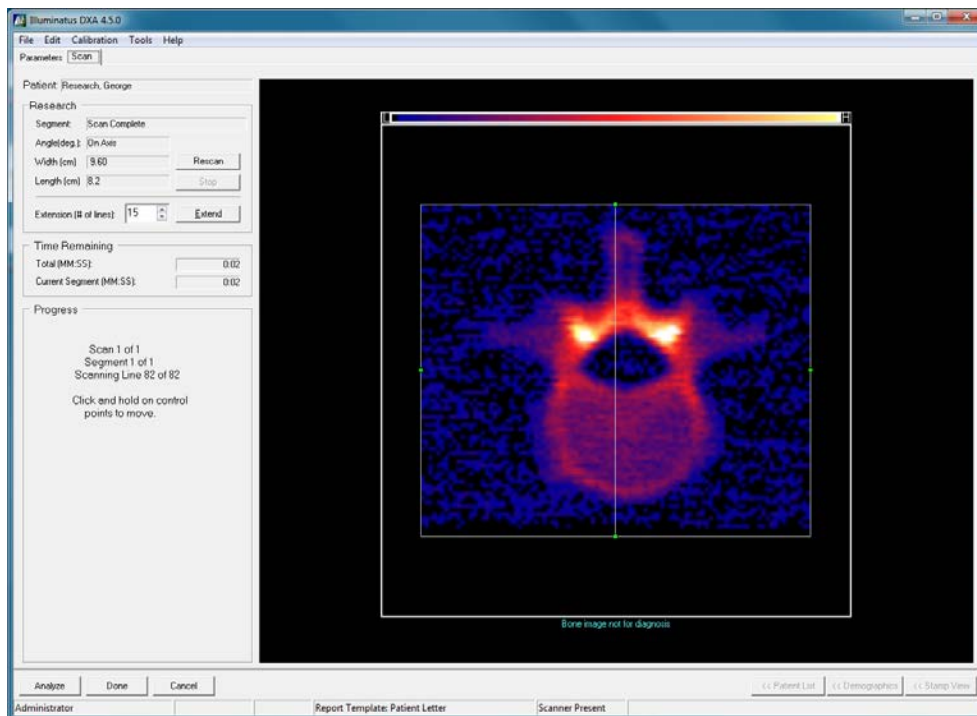

5. Determine if the quality of the Measure Scan image is satisfactory or unsatisfactory.
6. **IF THE IMAGE QUALITY IS SATISFACTORY**, and no evidence of patient movement during the scan is exhibited, proceed to Step 8.
7. **IF THE IMAGE QUALITY IS NOT SATISFACTORY**: do ONE of the following:
 - » Enter the appropriate number of scan lines in “Extension (# of lines)” and click to include the entire region of interest.
 - » OR click and remark the scan region (go to "Marking the Scan Region" on page 9-11).
8. If no further scans are to be performed, help the patient up from the scanner table (if applicable). Make sure the scanner arm will not impede the patient's ability to sit up.



Caution: Remember that some patients may require a few minutes to regain equilibrium after lying down for a length of time.

Analyzing the Scan

At this point, the operator can analyze the scan later, or analyze the scan now.

ANALYZE LATER: Click to end the scan process and analyze the scan later. The scan data will be saved to the database for analysis at a later time. The software will go back to the Parameter tab window. You can do another type of scan, if desired.

OR ANALYZE NOW . . .

1. Click .

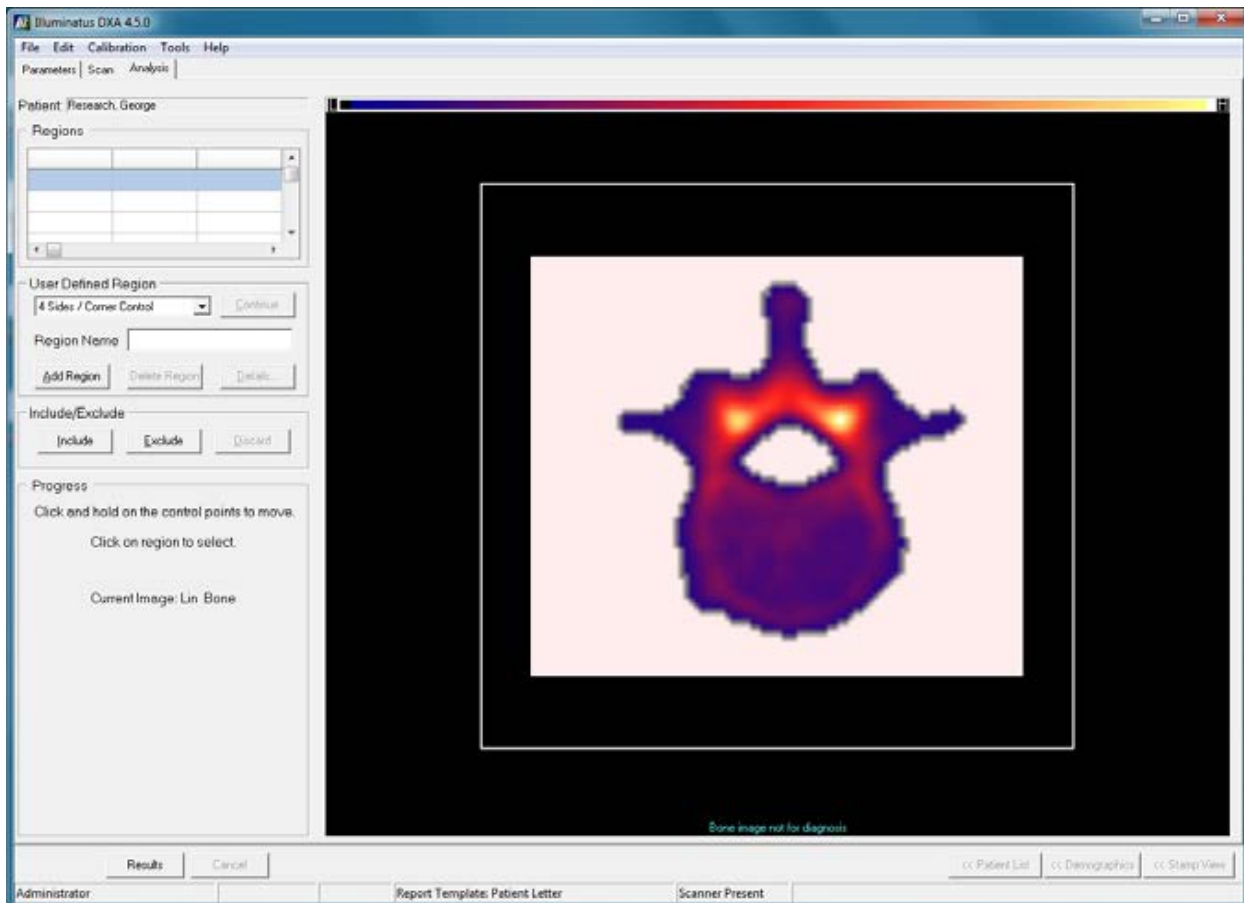

2. When the Analysis tab window opens, you will need to create and position Special Region Cursors to identify the regions of interest (see "Special Region Cursors " on page 11-38 for full instructions).
 - » Research/Small Subject scans can analyze up to 7 regions of interest per study.
 - » Name the regions in a consistent manner with the protocol.
 - » A Research scan of a vertebral body is used in this example.
3. In the User Defined Region drop-down list, select the desired region shape.
4. Type in a Region Name (*Transverse* was used here). Click .

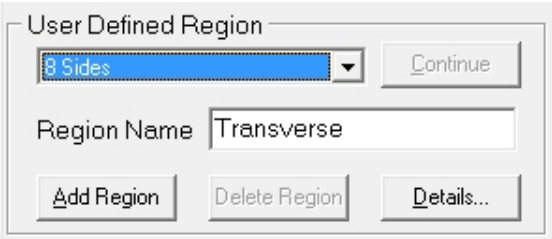

The dialog box titled "User Defined Region" contains a dropdown menu with "8 Sides" selected, a "Continue" button, a text field for "Region Name" containing "Transverse", and three buttons: "Add Region", "Delete Region", and "Details..."

5. Continue to add regions in accordance to the protocol. Different protocols have different specifications.

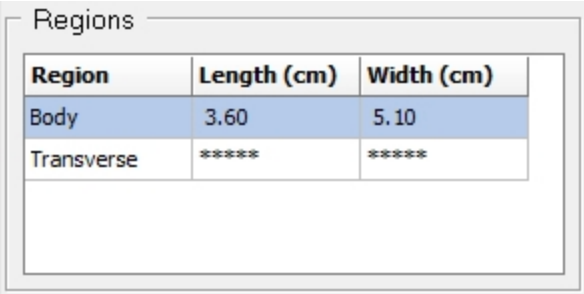

The "Regions" table lists two regions: "Body" with a length of 3.60 cm and a width of 5.10 cm, and "Transverse" with asterisks in both length and width columns.

Region	Length (cm)	Width (cm)
Body	3.60	5.10
Transverse	*****	*****

6. If the patient/subject has a prior scan, use the **Show Comparison** feature to aid in positioning the cursors in the same place as the subject's initial scan (refer to "Comparison Image" on page 11-54).

Viewing the Scan Results Tab

- Once all the regions are properly defined, click . The Scan Results tab window opens.

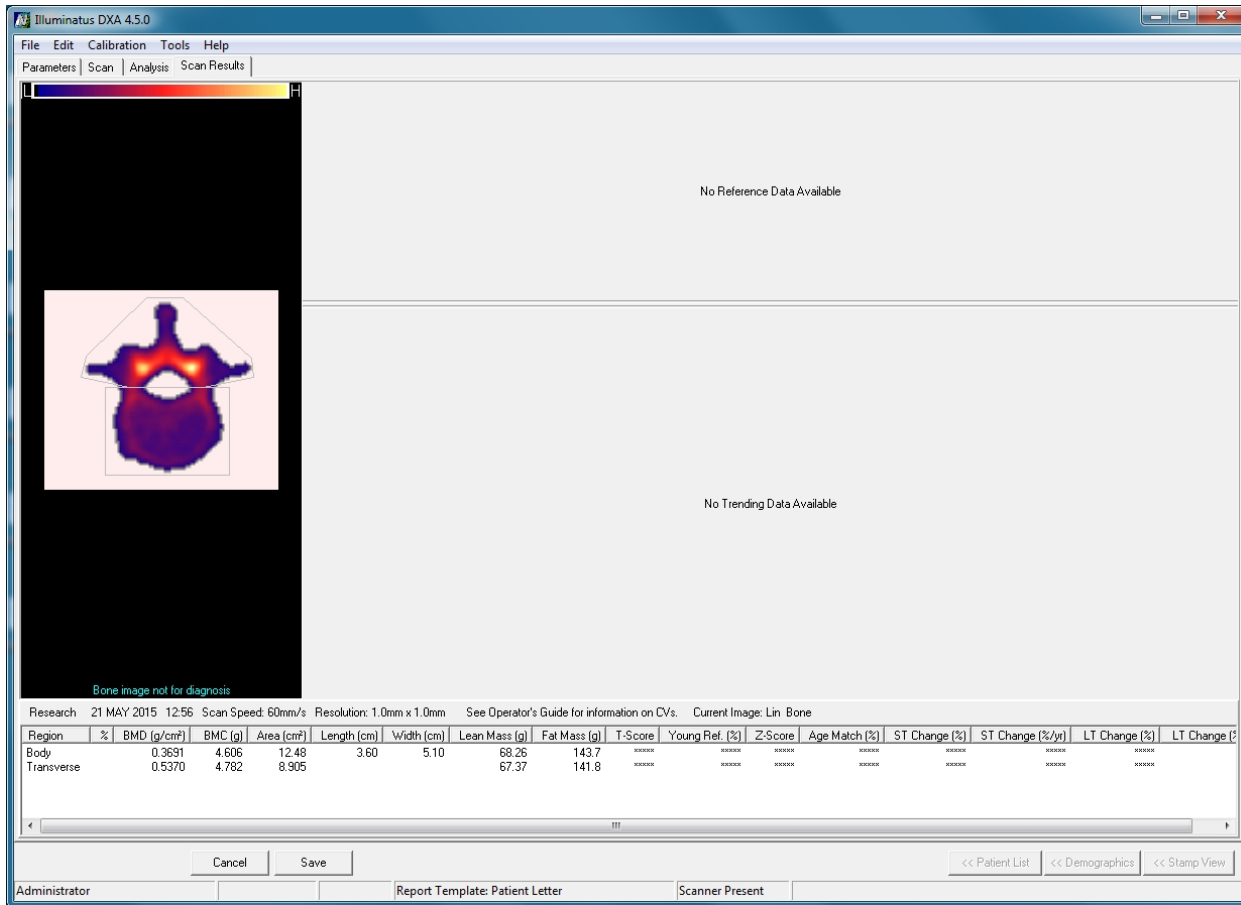

- View the image (which is not for diagnostic purposes) to ensure that cursors are positioned correctly and analysis results are satisfactory.

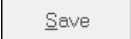
- Click  to save the Scan Results.

- » The image will display with trending graphs to the right of the image.
- » The BMD (in g/cm²), BMC (in grams), and AREA (in cm²) for each region of interest will be displayed below the graphs. The length and width of each ROI will also be displayed.
- » Soft Tissue values will be presented if Soft Tissue Composition option is enabled.



Note: The Show Baseline mode is recommended for viewing bone and non-bone pixels.

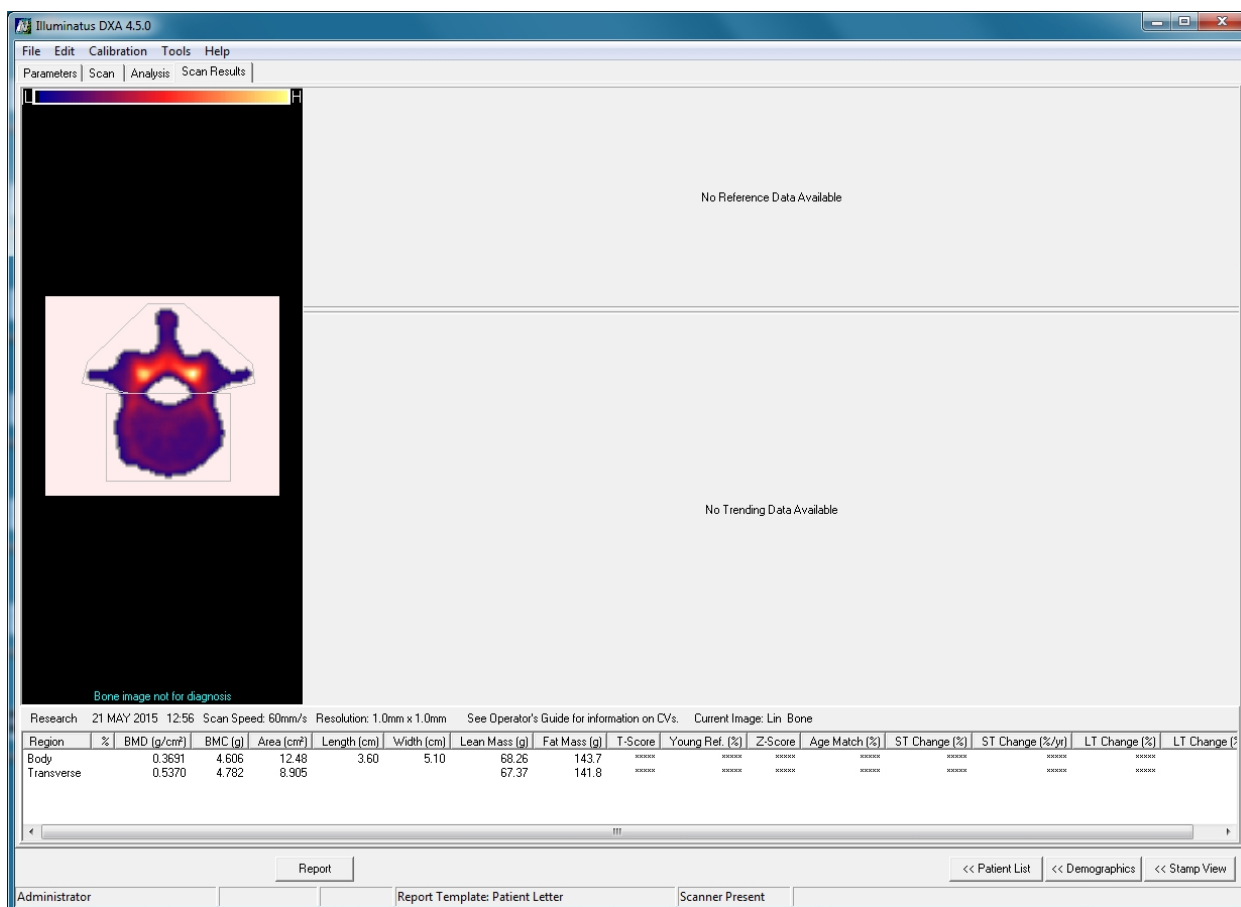

- » Click to generate and print a report using the current default report template. Proceed to Step 5 of "Generate and Print a Report" on the next page.
- » or click to generate and print a report using a report template other than the default. Proceed to "Generate and Print a Report" on the next page.
- » or click to do another scan.
- » or click to end the process and return to the main window.

Generate and Print a Report

Five different types of Reports can be generated for each scan: the *Bone Exam Report*, the *Bone Exam Report - 1 Page*, the *Combined Report*, the *Patient Letter*, and the *Referral Letter*. When saved, these reports become part of the scan data.

These procedures use the *Bone Exam Report - 1 Page* for the example.

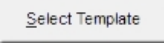
1. Make sure that the scanned image is being viewed as a thumbnail in the **Stamp View** or the **Filmstrip View**. Click (to highlight) the thumbnail view of the scan.
2. Click **Tools > Report > Select Template...** or click the  button to open the "Report Configuration" dialog box.

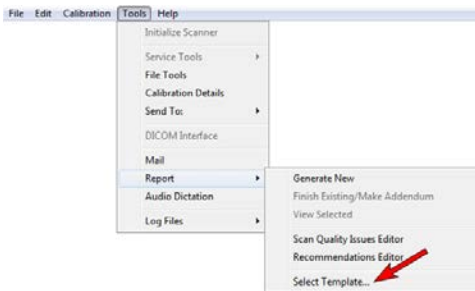

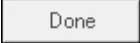
3. When the **Report Configuration** dialog box opens, click a Report Template to highlight it (*Bone Exam Report - 1 Page* was selected here). See "Sample Scan Reports" on page 2-17 for examples of the report template selections. Click .

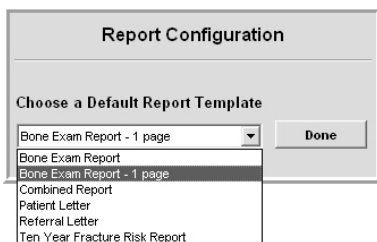

 **Note:** The selected Report Template will remain the default until it is changed. The currently selected Report Template is always displayed at the bottom of the IlluminatusDXA window.

4. Click **Tools > Report > Generate New** or click the  button.

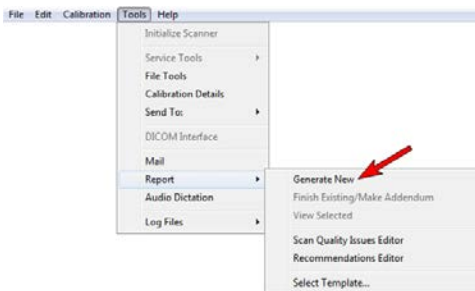

5. The Report is immediately generated and opens up in the window, as shown. At this point, the operator can type in their comments and recommendations, *Lock* it, *Save* it, *Print* it, *Export* it to a PDF file (or a DICOM file) and *Close* it.

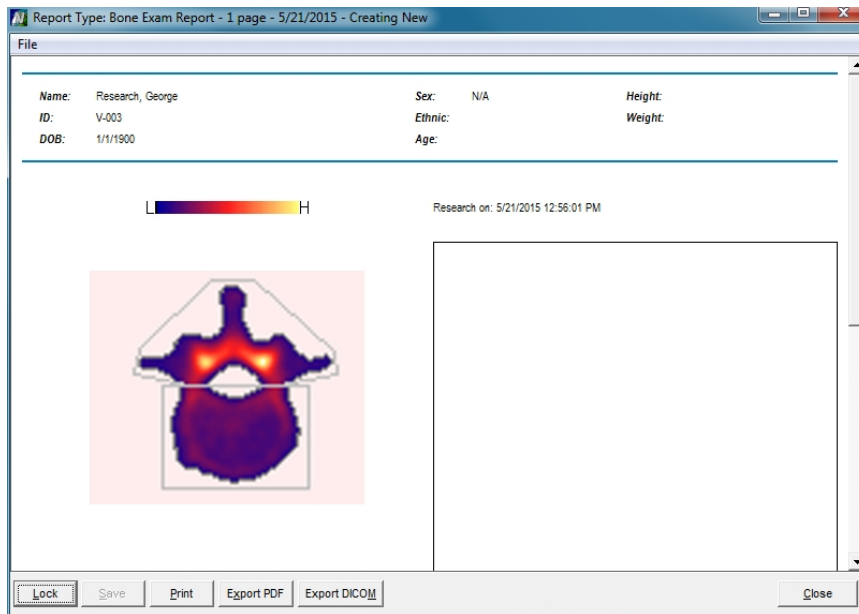

6. Click . The "Print" window appears. Select a printer, select which pages to print and choose how many copies to print.
7. Click to print the Report. The Report is automatically saved and printed.
8. Click .
9. You are returned to the Filmstrip view screen. The saved Report can be found under the "Reports" tab. The Report can be viewed, modified and reprinted at any time. See "The "Reports" Tab" on page 2-14 for more information.

A Sample Bone Exam Report - 1 Page



Figure 9-3: A sample Bone Exam Report - 1 Page for a Research Scan

CHAPTER 10

Scanning Lateral Spine



Note: The Lateral Spine Scanning feature is available as an option with the Norland Bone Densitometer. Be aware that your system might not have this option.

The Lateral Spine Scan procedure estimates bone mineral in the lumbar spine using a lateral projection. The region of interest is the L2, L3 and L4 vertebral bodies. The analysis software excludes the posterior elements from the calculations.

The process begins with a Scout scan over the lumbar spine area. The Scout scan should start 2-cm above the lowest point of the rib cage and extend to 2-cm below the iliac crests along a center line that is approximately 10-cm anterior to the patient's back. The operator visually confirms the computer defined measurement regions of interest are correct, then the Measure scan is taken.



Figure 10-1: Patient positioning for the Lateral Spine Scan

This chapter discusses the following.

Scan Specifications	10-2
Maintaining High Quality Lateral Spine Scans	10-4
General Patient Scanning Cautions	10-5
Quick Reference Guide - Lateral Spine Scan	10-6
Scan Procedures	10-7
Analyzing the Scan	10-21
Viewing the Scan Results Tab	10-24
Generate and Print a Report	10-26
A Sample Bone Exam Report	10-28

Scan Specifications

Table 10-1: Detailed Lateral Spine Scan Specifications

Scan Site	Lumbar Spine (L2-L3, L3, L3-L4) - Lateral View
Accuracy ^a	Typically within 1.0% of industry standard
In vivo Precision ^b	See table below
Scout Scan Resolution	1.5mm x 3.0mm: Point resolution x line spacing (pixel size)
Scout Scan Speed	130mm/sec
Measure Scan Resolution	1.0mm x 1.0mm: Point resolution x line spacing (pixel size)

Table 10-2: Lateral Spine Scan In vivo Precision

Measure Scan Mode	Measure Scan Speed	Two Vertebra C.V.			Single Vertebra C.V.		
		BMD	BMC	AREA	BMD	BMC	AREA
High Precision	15mm/sec	2.4%	3.7%	2.2%	2.7%	4.5%	3.6%
Standard	30mm/sec	3.7%	6.1%	3.3%	4.5%	6.7%	3.3%
*** All specifications are subject to change without notice. ***							

^aBased on Standard Speed scans of an anthropomorphic phantom.

^bBased upon 42 scans of 7 subjects (single vertebra) and 33 scans of 3 subjects (two vertebra) using standard procedures.

Patient Dose



Note: The radiation dose to the patient is dependent on the type of scan procedure and the body thickness of the patient.

Table 10-3: Scout Scan Skin Entrance Dose

Patient Thickness (cm)	Entrance Dose (μSv)
0-3	0.2
4-6	0.3
7-9	0.4
10-12	0.5
13-15	1.0
16-18	1.7
19-21	3.2
>21	4.9

Table 10-4: Measure Scan Skin Entrance Dose (μSv)

Patient Thickness (cm)	High Precision (μSv)	Standard (μSv)	High Speed (μSv)
0-7	5.1	2.6	1.3
8-10	7.3	3.7	1.8
11-13	10.7	5.4	2.7
14-16	13.3	6.7	3.3
17-19	25.3	12.7	6.3
20-22	42.7	21.3	10.7
23-25	79.3	39.7	19.8
>25	123.3	61.7	30.8

Operator Dose



Note: The dose to the operator is negligible. During a scan, the radiation level at a distance of one meter from the scanner table is less than 1.0 microsieverts per hour.

Maintaining High Quality Lateral Spine Scans

Patient positioning, scan and analysis techniques can influence the precision and accuracy of Bone Density estimations. Facilities can reduce the adverse effects of some of these factors by:

- » Performing and monitoring the daily QA procedure to verify that other radiation sources (x-ray machines, nuclear imagers) are not affecting the performance of the Norland system. The daily QA procedure verifies proper operation as well.
- » Ensuring that all operators position patients and analyze data in the same manner.
- » Screening patients for recent radionuclide uptake procedures. Residual emission may be misinterpreted by Norland Bone Densitometers as x-rays.
- » Screening patients for recent ingestion of radiopaque substances. Barium or other dyes used in some x-ray procedures could result in increased soft tissue x-ray absorption.
- » Screening patients for prosthetic devices, implants, surgical staples, or other high density sub-dermal materials that may affect density estimates.
- » Ensuring that scan and analysis parameters remain constant for all scans of the same patient.

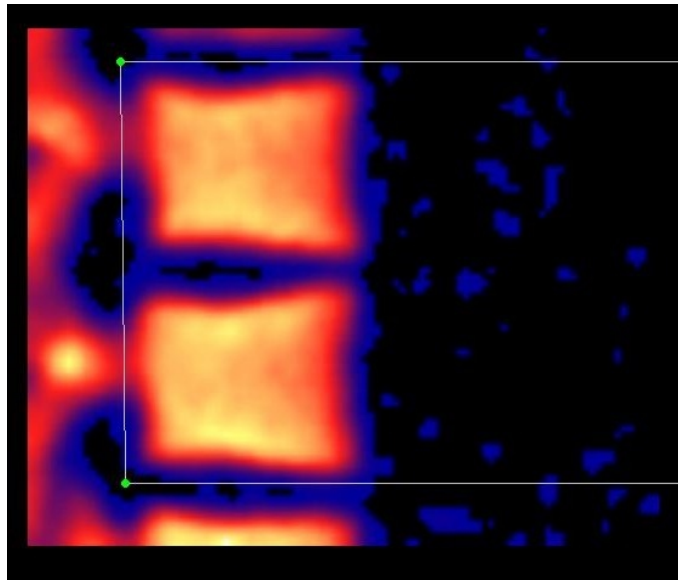

Figure 10-2: Example of a Good Quality Lateral Spine Scan

Note that:

- » the spine is straight.
- » the vertebrae are encompassed by the cursors and positioned properly.
- » the ribs are not obscuring L2 and/or the crest is not obscuring L4.

General Patient Scanning Cautions



Caution: Properly Mark the Patient. To ensure scanner arm does not contact the patient, always verify patient is positioned properly before scanning or moving the scanner arm.



Caution: Do not move the patient while marking the regions to be scanned. Always remain near the patient, in the event assistance is needed.



Caution: Do not touch the patient and the computer system at the same time as this could increase leakage currents.



Caution: Do not reach around to the back of the unit while the scanner arm is moving. While guards are provided, it is wise to avoid any chance of pinching the arm, hand, or fingers between the scanner arm and the frame, or between the source and the scanner arm.



Caution: Do not allow the patient to bump, push, or lean on the scanner arm. Manually moving the arm could result in an error message which will require removing the patient from the table and doing the Find Table Dimensions routine.



Caution: Make certain the patient does not dangle their arm or hand over the riser while the scanner arm is moving during a scan. The scan will not be usable, as the patient will not be properly positioned, and the patient may be at risk of pinching their hand or finger between the scanner arm and the riser or between the x-ray source and the scanner arm.



Caution: Make certain the patient does not stick a finger into the slot in the bottom of the upper arm cover during a scan; it could be pinched.



Caution: When positioning the patient, ensure they start by sitting near the center of the table and then swing their legs up. Sitting at either end makes positioning awkward.







Caution: Caution the patient to remain still during the scan to ensure quality results.



Caution: Help the patient up from the scanner after scan data collection; some patients may require a few minutes to regain equilibrium after lying down for a length of time.











Quick Reference Guide - Lateral Spine Scan

The Lateral Spine scan procedure consists of a brief Scout Scan over the lumbar area, a Measure Scan, calculation of numeric results, and the saving and printing of the data.

- » Screen patient for contraindications.
- » In the Database Navigator window, click on the *existing* patient's name, then click  OR click  to start a *new* record.
- » Update (or enter) the patient's Demographic information.
- » Click . Click the Lateral Spine button. Click . Check the parameters.
- » Place the Leg Rest, Back Rest, and the Rib Cage Support blocks in position on the scanner table.
- » Position the patient on their left side, with back against the Back Rest block. Position the Leg Rest block so that the patient's legs form a 135° angle. Support the ribs with the Rib Cage Support block and place the Head Roll under the patient's head. Place the Limb blocks between the arms and legs. Position the scanner arm over the patient's midsection.

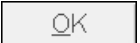
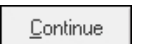
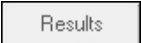

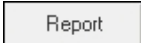
Caution: Caution the patient not to stare into the beam.

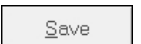
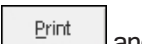
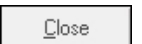
- » Click  in the Parameters tab window.
- » MARKING THE START POINT: Turn ON the laser. Position the laser dot 2-cm above the lowest point of the rib cage and 7-cm to 10-cm anterior (forward) of the patient's back, then press the  button on the Scanner Arm Touch Pad.
- » MARKING THE END POINT: Position the laser dot 2-cm below the iliac crest and press the  button.
- » MARKING THE BASELINE POINT: Position the laser dot over the abdominal region, 5-cm anterior to the spine and press the  button.
- » Click  to begin the Scout Scan.
- » When the Scout Scan is finished, use the cursors to encompass L3 (single vertebra), L2-L3, or L3-L4 (multiple vertebrae). Position the center line to touch the anterior edge of vertebra(e).
- » Click . Allow the measure scan to complete. If the scan is satisfactory, click .
- » If you are done scanning, assist the patient up from the table.
- » Select the region to be analyzed in the "Regions" window. Click .
- » Place the upper left control point inside the vertebral notch, above and to the left of the top vertebra. Place the bottom left control point inside notch, below and to the left of the bottom vertebra. Click .
- » Click . Click . Click  to print a Report (or click  to end the process and return to the main window).
- » Click ,  and then .

Scan Procedures

Checklist

You are almost ready to begin scanning. Confirm that the following tasks have been completed:

- » the system is running (see "Powering Up the System " on page 4-3)
- » the System Calibrations are done (see "Daily Calibration Procedure" on page 4-6)
- » the Database Navigator window is open (Figure 4-3: on page 4-5)

Preparing the Patient for Scanning

Ensure that the patient has removed all items from their pockets and that clothing is free of metal (i.e. rivets, buttons, zippers) or anything else that might be of a high density. It might be necessary to have the patient change to an examination gown or robe. Shoes should also be removed.

Update (or Create) the Patient's Record

EXISTING PATIENT: From the Database Navigator window, double-click on the existing patient's name to open the patient's record. Update the patient's information. (If necessary, refer to "Enter Data into the Existing Patient's Record" on page 4-24 for instructions.)

You are now ready to begin the scan process.

Proceed with "Setting the Scan Parameters" on page 7-8 to continue.

NEW PATIENT: From the Database Navigator window, click on to start a new record. Enter all the patient information. (If necessary, refer to "Preparing Patient Records" on page 4-21 for instructions.)

You are now ready to begin the scan process.

Proceed with "Setting the Scan Parameters" on page 7-8 to continue.

Setting the Scan Parameters

1. Click .
2. Click Lateral Spine in the pop-up window.



3. Click .
4. The Parameters tab window opens.

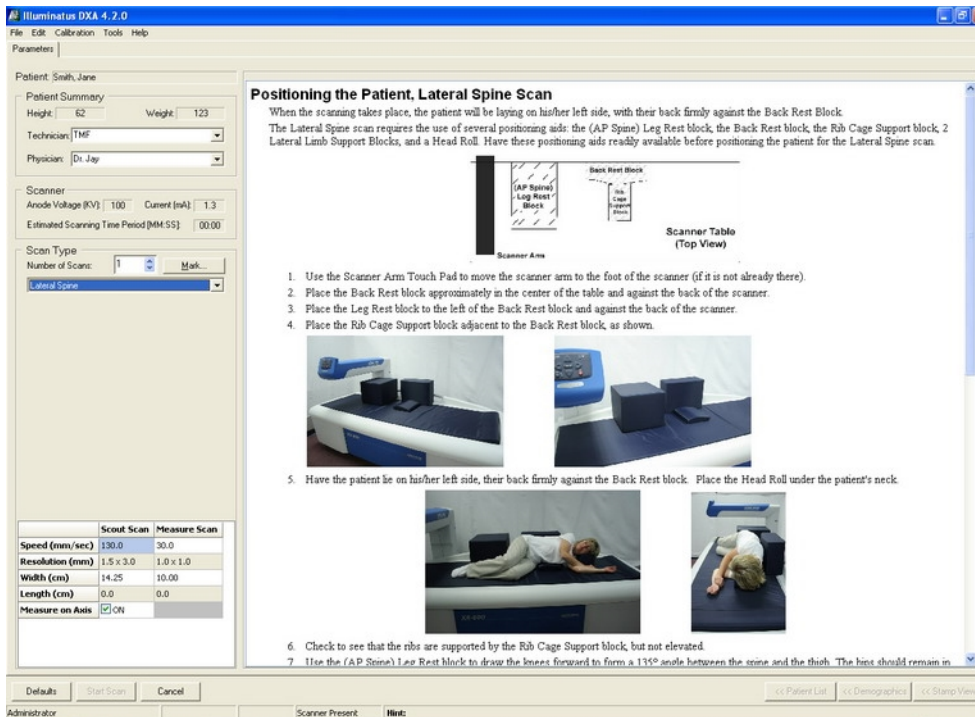

Figure 10-3: The Lateral Spine Scan Parameters tab window

5. The scan parameters are shown in the bottom left hand side of the Parameters tab window, and reproduced here for reference. Norland recommends that the factory default parameter settings be used for scanning. The default values are shown below.

	Scout Scan	Measure Scan
Speed (mm/sec)	130.0	30.0
Resolution (mm)	1.5 x 3.0	1.0 x 1.0
Width (cm)	14.25	10.00
Length (cm)	0.0	0.0
Measure on Axis	<input checked="" type="checkbox"/> ON	

- » To reset values to factory defaults, see "Preferences: Lateral Spine Scan" on page 3-28.
 - » For a full explanation of the Lateral Spine Scan parameters (i.e. preferences) see "Preferences: Lateral Spine Scan" on page 3-28.
 - » If it is necessary to change the Speed or Measure on Axis parameters, see "Changing the Scan Parameters Prior to Scanning" on page 11-76.
6. Proceed to "Positioning the Patient " on the next page to continue.

Positioning the Patient

Refer to the patient positioning photos and instructions in the Norland software (Parameters tab window). The steps and photos are reprinted in the manual for reference.

The screenshot shows the 'Parameters' window in the Illuminator DXA 4.2.0 software. The 'Patient' section lists 'Smith, Jane' with height 62 and weight 123. The 'Scanner' section shows 'Anode Voltage (KV)' at 100 and 'Current (mA)' at 1.3. The 'Scan Type' is set to 'Lateral Spine'. A table at the bottom left compares 'Scout Scan' and 'Measure Scan' parameters.

	Scout Scan	Measure Scan
Speed (mm/sec)	130.0	30.0
Resolution (mm)	1.5 x 3.0	1.0 x 1.0
Width (cm)	14.25	10.00
Length (cm)	0.0	0.0
Measure on Axis	<input checked="" type="checkbox"/>	<input type="checkbox"/>

The main window displays the following instructions and diagrams:

Positioning the Patient. Lateral Spine Scan

When the scanning takes place, the patient will be lying on his/her left side, with their back firmly against the Back Rest Block.

The Lateral Spine scan requires the use of several positioning aids: the (AP Spine) Leg Rest block, the Back Rest block, the Rib Cage Support block, 2 Lateral Limb Support Blocks, and a Head Roll. Have these positioning aids readily available before positioning the patient for the Lateral Spine scan.

- Use the Scanner Arm Touch Pad to move the scanner arm to the foot of the scanner (if it is not already there).
- Place the Back Rest block approximately in the center of the table and against the back of the scanner.
- Place the Leg Rest block to the left of the Back Rest block and against the back of the scanner.
- Place the Rib Cage Support block adjacent to the Back Rest block, as shown.

5. Have the patient lie on his/her left side, their back firmly against the Back Rest block. Place the Head Roll under the patient's neck.

- Check to see that the ribs are supported by the Rib Cage Support block, but not elevated.
- Use the (AP Spine) Leg Rest block to draw the knees forward to form a 135° angle between the torso and the thigh. The feet should remain in...

When the scanning takes place, the patient will be laying on his/her left side, with their back firmly against the Back Rest block.

The Lateral Spine scan requires the use of several positioning aids: the (AP Spine) Leg Rest block, the Back Rest block, the Rib Cage Support block, 2 Lateral Limb Support blocks, and a Head Roll. Have these positioning aids readily available before positioning the patient for the Lateral Spine scan.

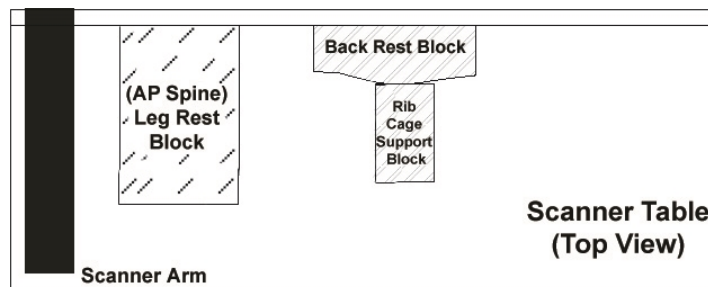

1. Use the Scanner Arm Touch Pad to move the scanner arm to the foot of the scanner (if it is not already there).
2. Place the Back Rest block approximately in the center of the table and against the back of the scanner.
3. Place the Leg Rest block to the left of the Back Rest block and against the back of the scanner.
4. Place the Rib Cage Support block adjacent to the Back Rest block, as shown.



5. Have the patient lie on their left side, their back firmly against the Back Rest block. Place the Head Roll under the patient's neck.



6. Check to see that the ribs are supported by the Rib Cage Support block, but not elevated.
7. Use the (AP Spine) Leg Rest block to draw the knees forward to form a 135° angle between the spine and the thigh. The hips should remain in a vertical line.

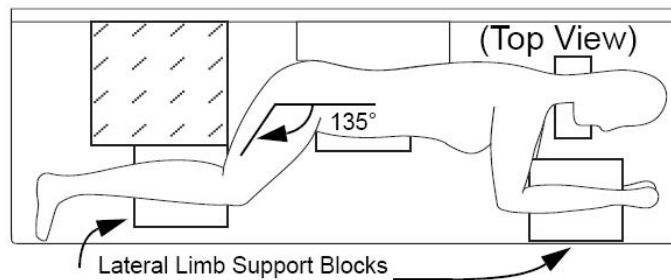

 **Note:** Make sure that the patient does not sag or droop forward.

8. Place a Lateral Limb Support block on top of the left leg, just below the knee. Rest the other leg on top of the Limb Support block.



9. Place the other Lateral Limb Support block on top of the left arm, just below the wrist. Rest the other arm on top of the Limb Support block. Position the shoulders in a vertical plane with arms at 90°.



10. The patient is now ready for scanning.
11. Make the patient as comfortable as possible since movement during the scan will affect the results. The use of a sheet or light blanket will not interfere with scan results. Use of a pillow or the Head Roll under the head is recommended.

Marking the Scan Region

1. Click in the Parameters tab window to open the dialog box.

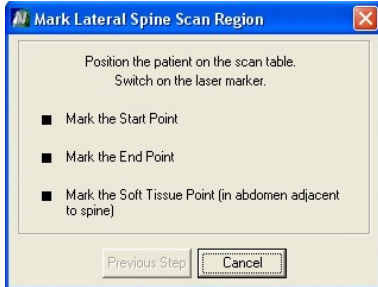

Caution: Caution the patient not to stare into the beam.

2. Draw an imaginary line parallel to the scanner back rest and 10-12-cm in front of the edge of the Back Rest block.
3. Ensure that the laser is OFF, then use the Scanner Arm Touch Pad arrows to move the scanner arm over the patient's midsection along this imaginary axis.

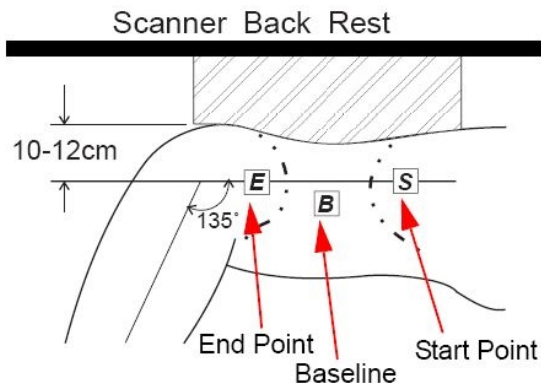

Figure 10-4: Typical Lateral Spine Scout Scan region



Note: Explanation: The typical Lateral Spine Scout scan region is from mid-L1 to the iliac crest, extending approximately 7-cm posterior to the anterior edge of the vertebral bodies and 7-cm into the abdomen (shown above).

Note that all of L2-L4 is included in the scan when the:



- » scan start point is 15-cm above the iliac crest (S)
- » and the scan end point is 2-cm below the iliac crest (E).

The soft tissue Baseline point (B) is marked anterior to the spine, not over bone.



Caution: Caution the patient not to stare into the beam.



4. Press  to turn the laser ON.
5. **MARKING THE START POINT (S)**: move the scanner arm until the dot is approximately 2-cm above the lowest point of the rib cage and press . (The computer will emit a sound, and the laser will flash.)

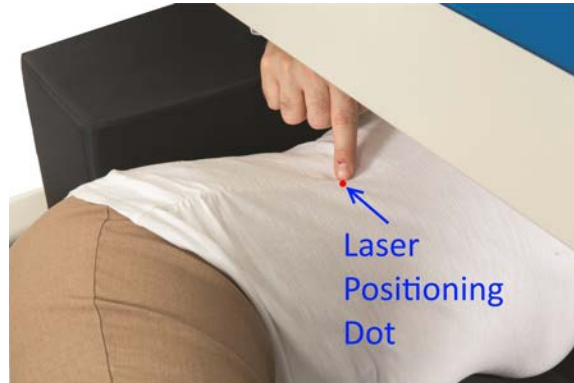

Note: Click in the dialog box to re-mark the Start Point. Click at any time to abort the marking operation.

6. **MARKING THE END POINT (E)**: move the scanner arm until the dot is about 2-cm below the iliac crest and press . (The computer will emit a sound and the laser will flash.)



7. **MARKING THE BASELINE POINT (B)**: move the scanner arm until the dot is at a point in the abdominal region, about 5-cm anterior (forward) from the spine and press .

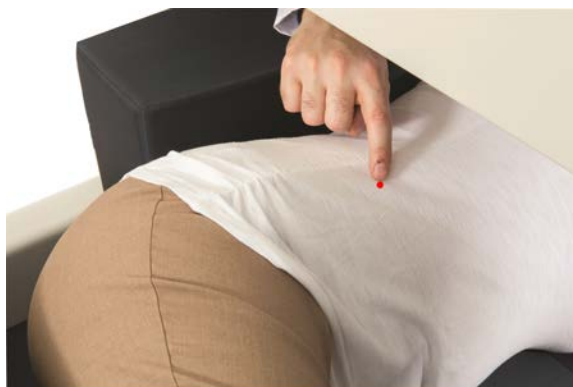

8. The computer will emit a sound and the laser will flash.
9. The dialog box will automatically close when the marking tasks are complete.

Starting the Scout Scan

Once the center of the femoral neck has been marked, the *Start Scan* button in the Parameters tab window will become available to the operator. Caution the patient to remain still.





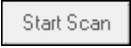

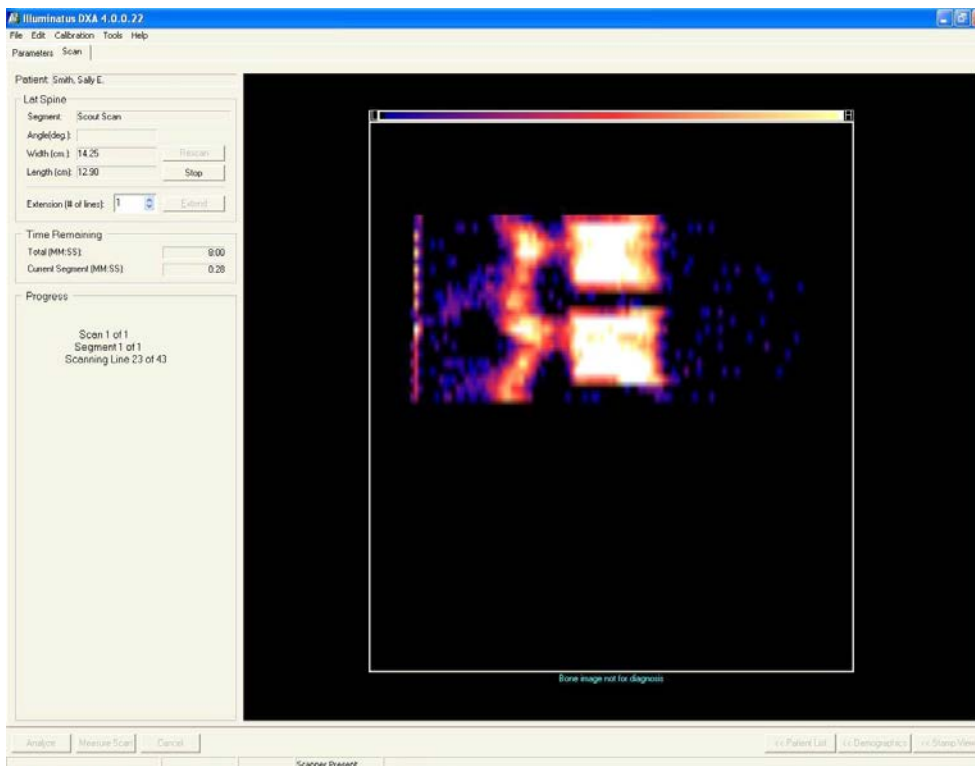
Remember, press the Emergency Stop button directly below the Scanner Arm Touch Pad to immediately terminate the x-ray exposure or stop the scanner arm movement. Refer to "Pressing the Emergency Stop Button" on page 11-37 for instructions on safely resuming the scan.

1. Click .
2. The Scan tab window displays the image as it develops, shows how many lines will be scanned and gives an estimate of the total time remaining in the Scout scan.

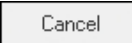

3. Monitor the image closely for any indication of patient movement. Cancel the scan immediately if the patient moves during the scan.

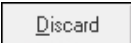
 **Note:** To cancel the scan: Click . Click .

Select  in the dialog box. Click .

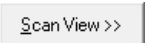
Click . Click . Select Lateral Spine.

Return to "Marking the Scan Region" on page 10-13 to continue.

- When the Scout Scan is complete, the computer will emit a sound. The software will update the Scan tab window and the *Measure Scan* button will become available.

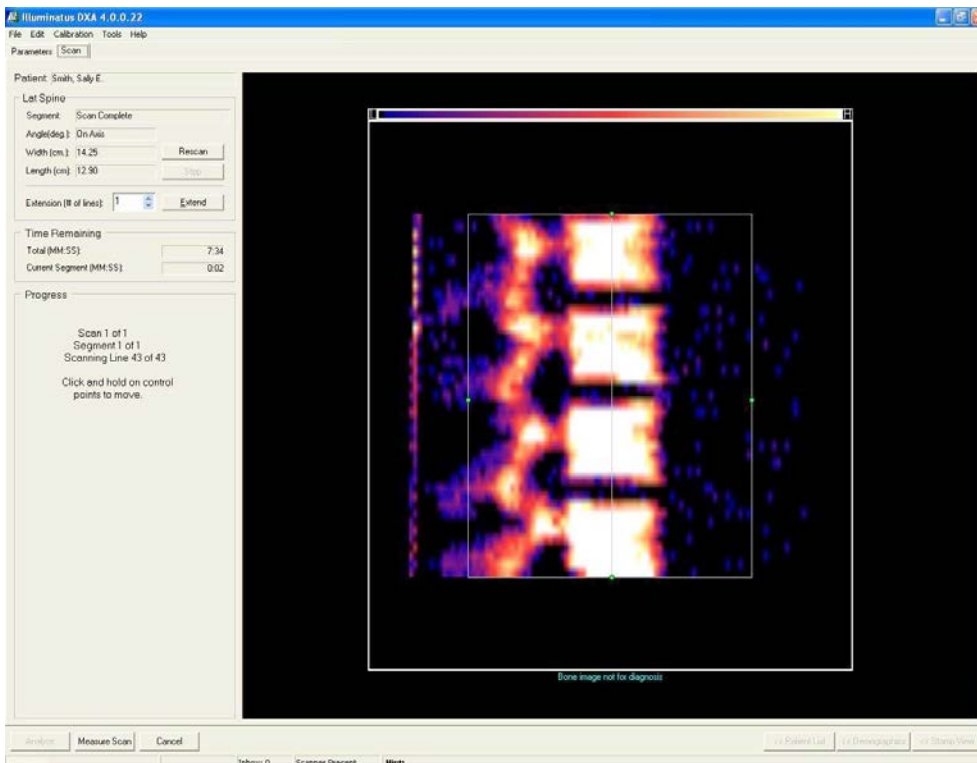

- Determine if the quality of the Scout Scan image is satisfactory or unsatisfactory.
- WHEN THE SCOUT SCAN IMAGE IS SATISFACTORY**, the image of the lumbar segment in the scan is straight. Since the factory setting for the *Measurement on Axis* is set to ON by default (enabled), the lumbar segment image must be straight so that the Measure Scan can be properly defined. Proceed to step 8.
- WHEN THE SCOUT SCAN IMAGE IS NOT SATISFACTORY**, the lumbar segment is not straight. Refer to the information in "Unsatisfactory Scout Scan (Lateral Spine)" on page 11-77 for further instructions.
- Click and drag to move the top and bottom of the cursor box to define the area to be measured. There are three distinct areas for measurement in a lateral spine scan: L2-L3, L3, or L3-L4. The table below describes where to place the cursor box for each of these three areas.

L3	Position the cursor to include the bottom third of L2 and the top surface of L4. Position the center line of the cursor box to just touch the anterior edge of L3.
L2-L3 or L3-L4	Position the cursor box to include portions of the adjoining vertebra above and below the two vertebrae being measured. Position the center line of the cursor box to just touch the anterior edge of the vertebrae.

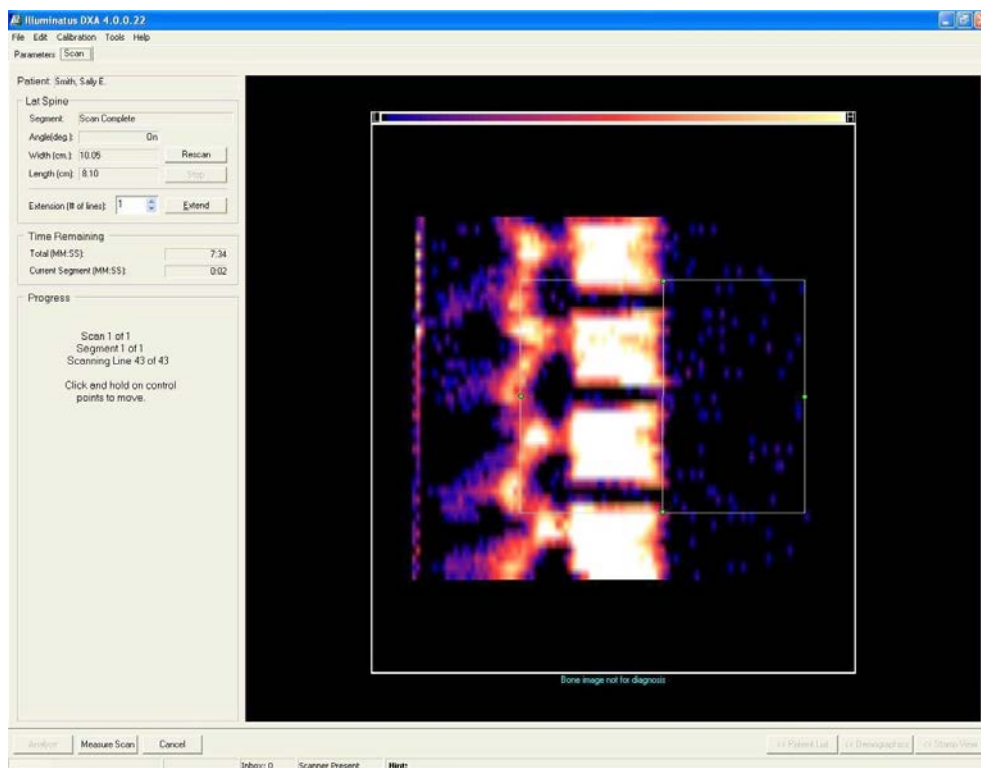

Starting the Measure Scan



Remember, press the Emergency Stop button  directly below the Scanner Arm Touch Pad to immediately terminate the x-ray exposure or stop the scanner arm movement. Refer to "Pressing the Emergency Stop Button" on page 11-37 for instructions on safely resuming the scan.

1. Click on .
2. The Scan tab window displays the image as it develops, shows how many lines will be scanned and gives an estimate of the total time remaining in the Measure scan.

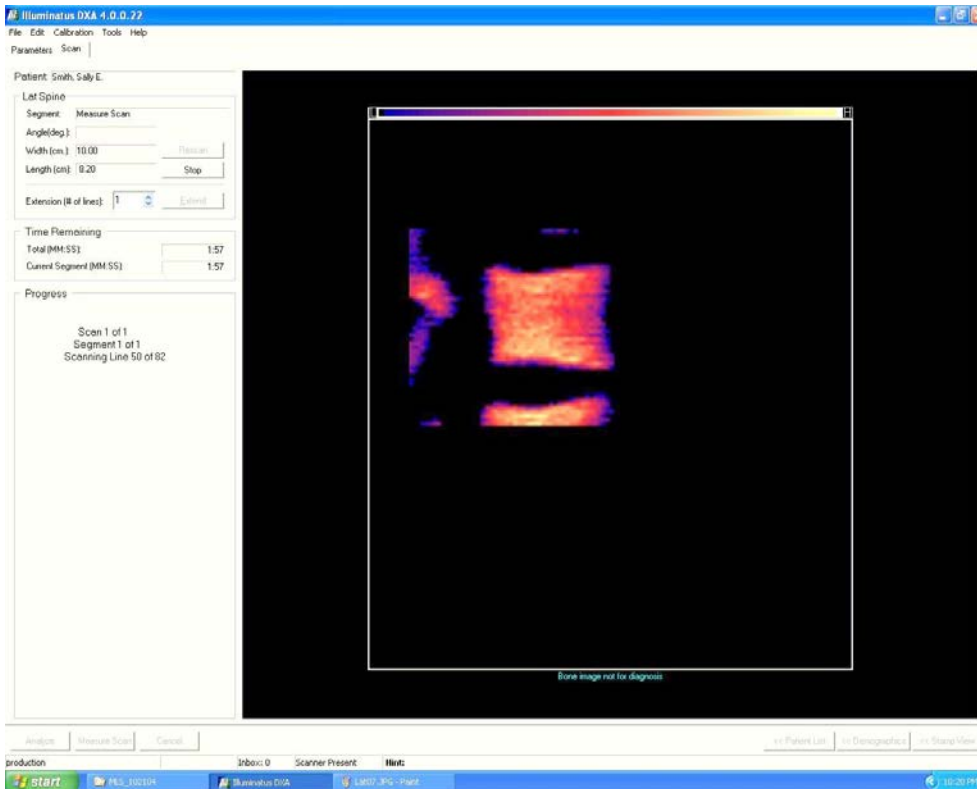

Note: Always allow the Measure Scan to complete without interruption. This will ensure that the region of interest is the same from scan to scan and will ensure the best precision.

3. Monitor the image closely for any indication of patient movement. Cancel the scan immediately if the patient moves during the scan.



Note: To cancel the scan: Click . Click .

Select in the dialog box. Click .

Click . Click . Select Lateral Spine.
Return to "Marking the Scan Region" on page 10-13 to continue.

4. When the Measure Scan is complete, the computer will emit a sound. The software will update the Scan tab window and the *Analyze* button will become available.

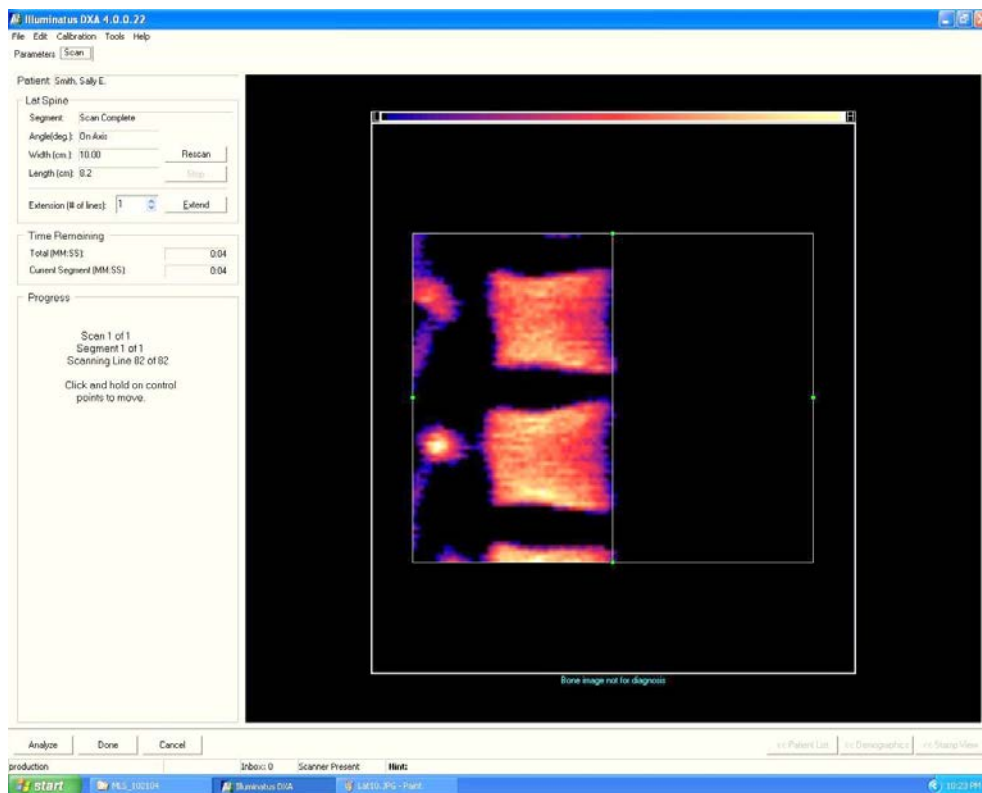

5. Determine if the quality of the Measure Scan image is satisfactory or unsatisfactory.
6. **IF THE IMAGE QUALITY IS SATISFACTORY**, proceed to Step 8.
7. **IF THE IMAGE QUALITY IS NOT SATISFACTORY**, do one of the following:

- » Enter the appropriate number of scan lines in "Extension (# of lines)" and click to include the entire region of interest.
 - » OR click and remark the scan region (see "Marking the Scan Region" on page 10-13).
8. Remove the Patient Positioning Aids and help the patient up from the scanner table if no further scans are to be performed. Make sure the scanner arm will not impede the patient's ability to sit up.



Caution: Remember that some patients may require a few minutes to regain equilibrium after lying down for a length of time.

Analyzing the Scan

At this point, the operator can analyze the scan later, or analyze the scan now.

ANALYZE LATER: Click to end the scan process and analyze the scan later. The scan data will be saved to the database for analysis at a later time. The software will go back to the Parameter tab window. You can do another type of scan, if desired.

OR ANALYZE NOW . . .

1. Click .

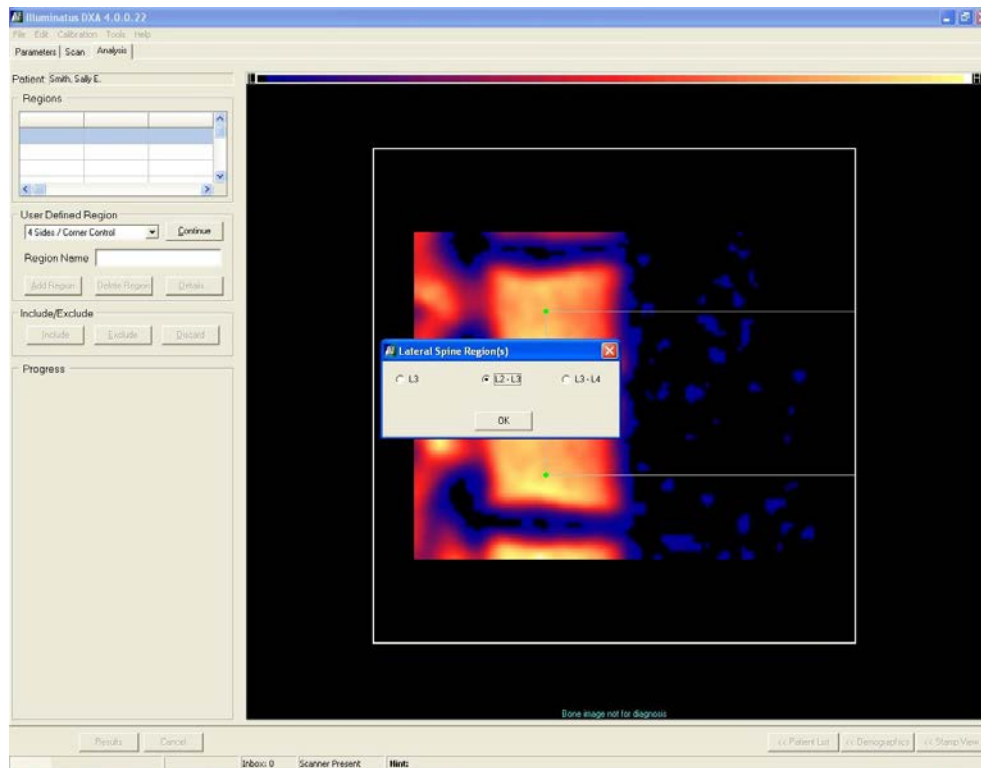

2. In the dialog box that pops up, select the region to be analyzed - L3, L2-L3, or L3-L4 - and click .
3. When the Analysis tab window opens, cursors will be displayed in the regions of interest.

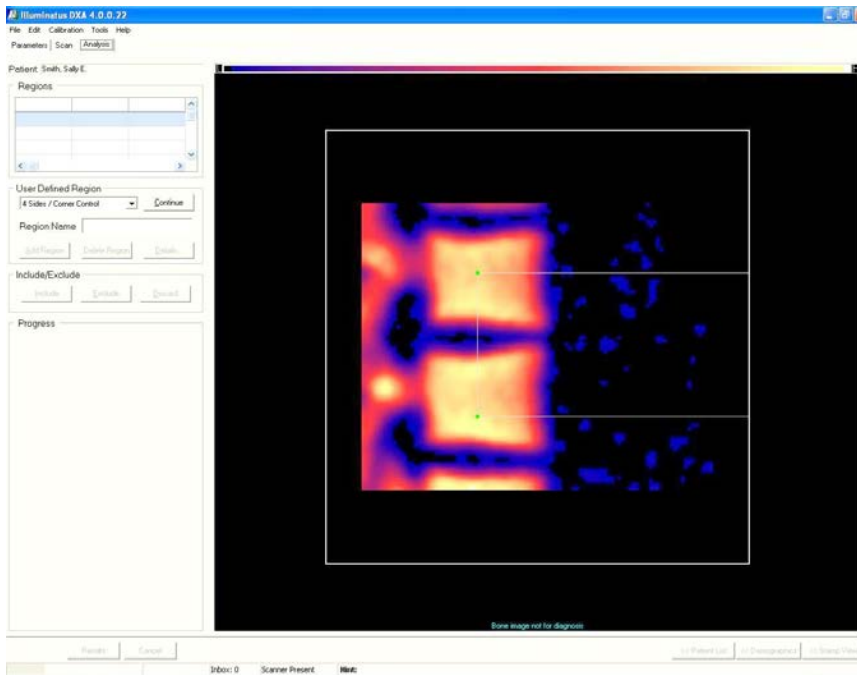

4. Click and drag to position the upper left control point inside the vertebral notch to a point just above and behind the upper vertebra to be analyzed.
5. Position the lower left control point inside the vertebral notch, below and behind the lower vertebra to be analyzed. The figure below shows the proper cursor positioning for L2-L3.

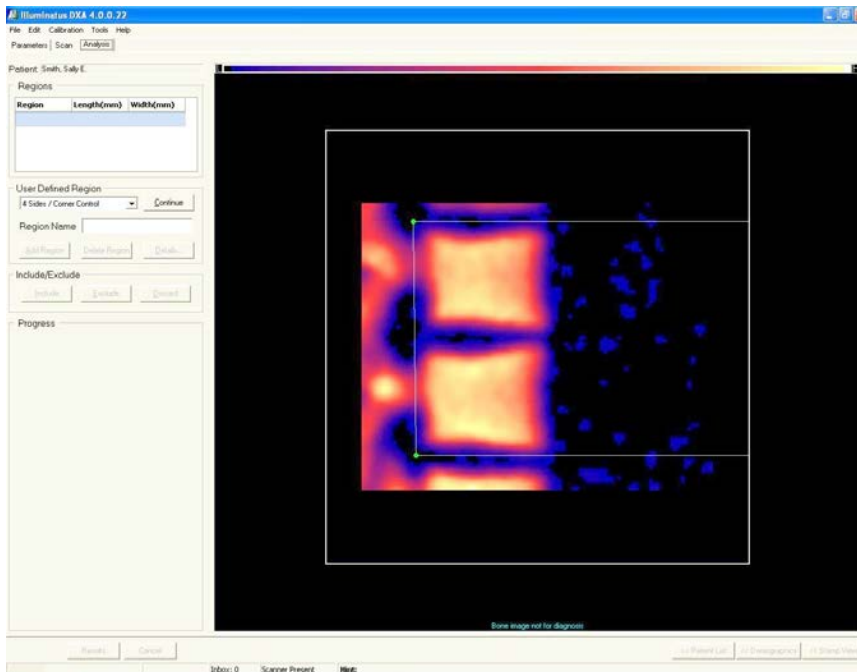

6. Click . The *Results* button will become available.
7. The system software will automatically proceed to find the intervertebral spaces and construct a cursor box that will contain each vertebra being analyzed with a minimum of soft tissue.

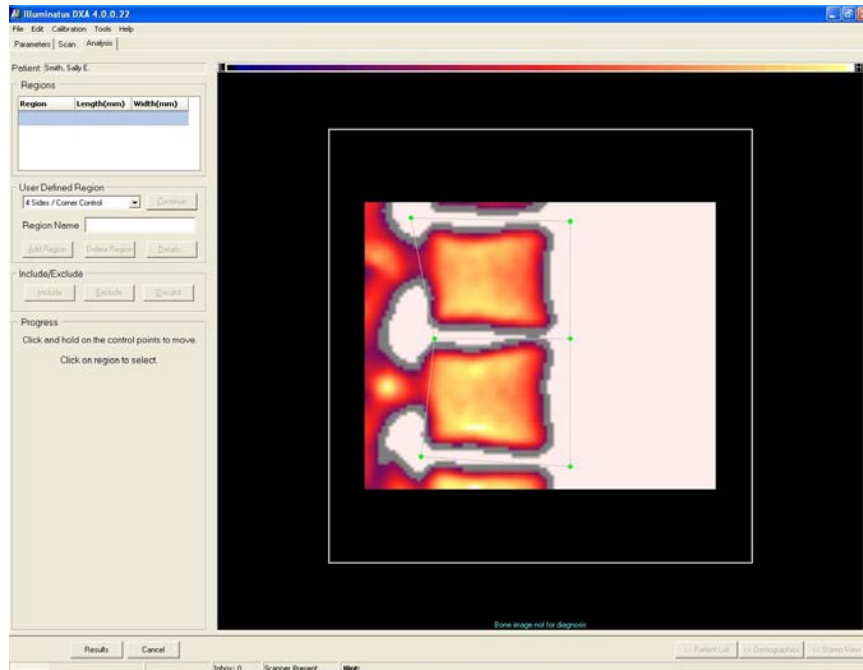

Note: Norland strongly recommends using the computer-generated analysis unless the regions of interest are blatantly incorrect.

8. Adjust the cursors, if needed.
9. If the patient has a prior Lateral Spine scan, use the Show Comparison feature to aid in positioning the cursors in a consistent fashion (see "Comparison Image" on page 11-54).

Viewing the Scan Results Tab

- Click . In this example, a prior Lateral Spine scan existed to plot a Trending Graph.

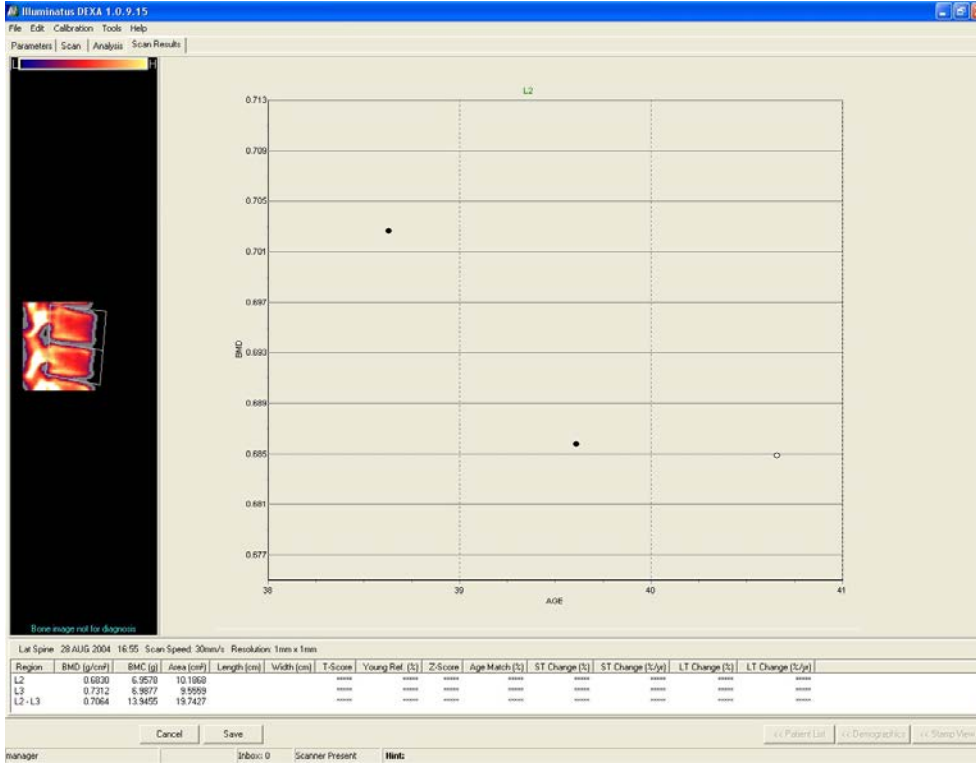

- Click .
- Numeric data is displayed at the bottom of the window for each of the individual vertebrae and the L2-L3 pair of vertebrae. If the patient has been scanned before, the values for % Short Term and % Long Term will also be displayed. Their definitions are given in the following table.

% SHORT TERM CHANGE	Ratio of change between current scan and most recent previous scan.
% LONG TERM CHANGE	Ratio of change between current scan and patient's initial scan.
%/YR value	Indicates the percent of change calculated per year

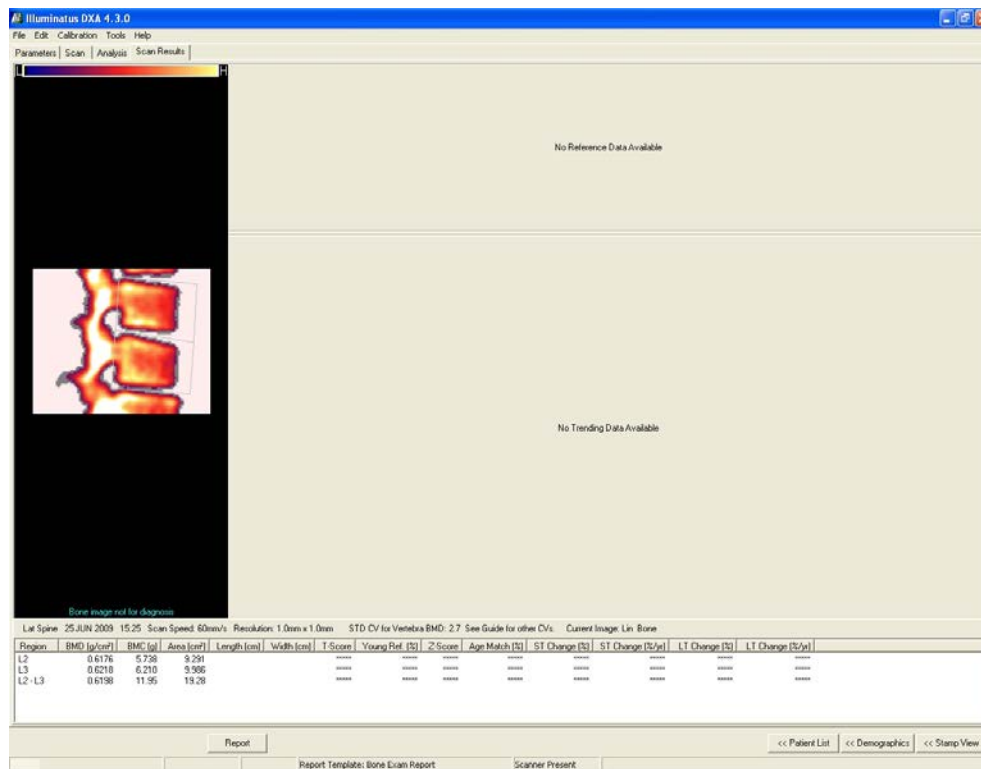

- » Click **Report** to generate and print a report using the current default report template. Proceed to Step 5 of "Generate and Print a Report" on the next page.
- » or click **Stamp View >>** to generate and print a report using a report template other than the default. Proceed to "Generate and Print a Report" on the next page.
- » or click **Demographics >>** to do another scan.
- » or click **<< Patient List** to end the process and return to the main window.

Generate and Print a Report

Five different types of Reports can be generated for each scan: the *Bone Exam Report*, the *Bone Exam Report - 1 Page*, the *Combined Report*, the *Patient Letter*, and the *Referral Letter*. When saved, these reports become part of the scan data.

These procedures use the *Bone Exam Report - 1 Page* for the example.

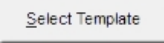
1. Make sure that the scanned image is being viewed as a thumbnail in the **Stamp View** or the **Filmstrip View**. Click (to highlight) the thumbnail view of the scan.
2. Click **Tools > Report > Select Template...** or click the  button to open the "Report Configuration" dialog box.

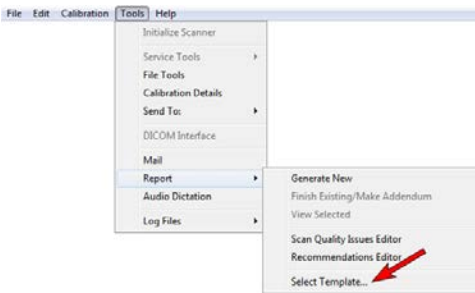

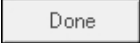
3. When the **Report Configuration** dialog box opens, click a Report Template to highlight it (*Bone Exam Report - 1 Page* was selected here). See "Sample Scan Reports" on page 2-17 for examples of the report template selections. Click .

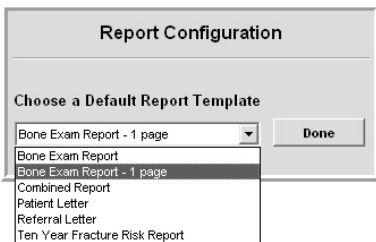

 **Note:** The selected Report Template will remain the default until it is changed. The currently selected Report Template is always displayed at the bottom of the IlluminatusDXA window.

4. Click **Tools > Report > Generate New** or click the  button.

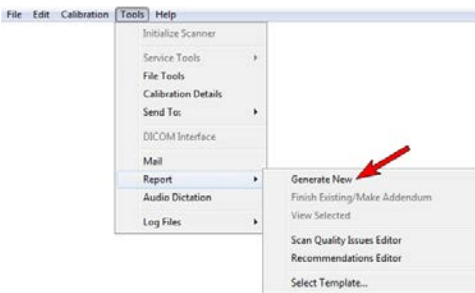

5. The Report is immediately generated and opens up in the window, as shown. At this point, the operator can type in their comments and recommendations, *Lock* it, *Save* it, *Print* it, *Export* it to a PDF file (or a DICOM file) and *Close* it.

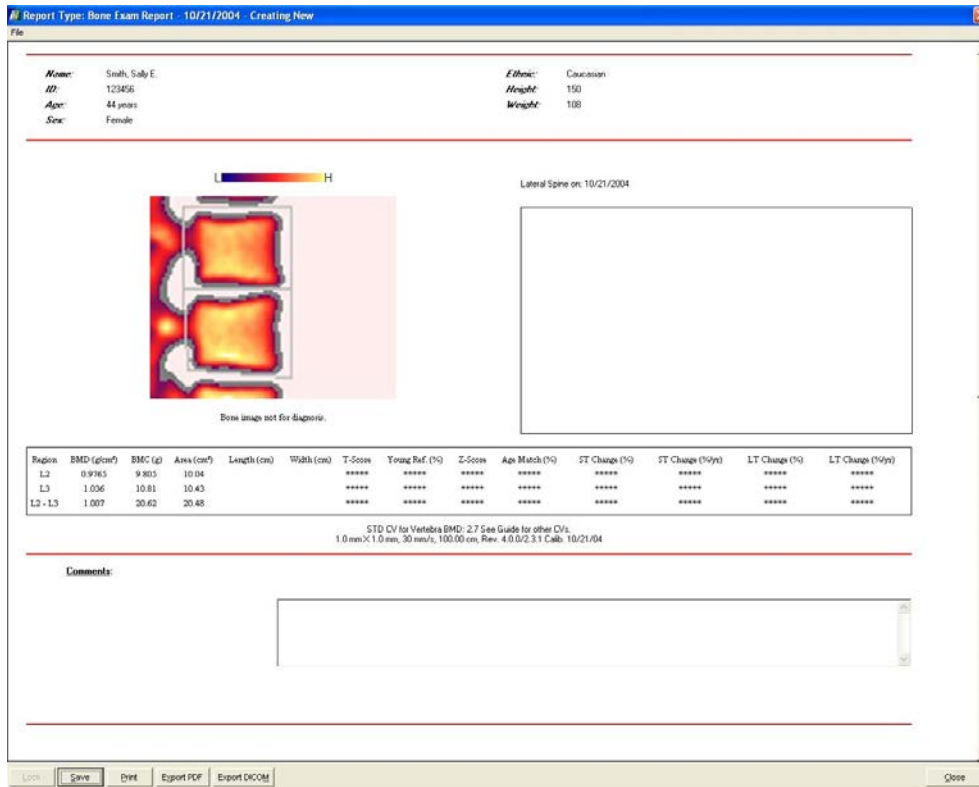

6. Click . The "Print" window appears. Select a printer, select which pages to print and choose how many copies to print.
7. Click to print the Report. The Report is automatically saved and printed.
8. Click .
9. You are returned to the Filmstrip view screen. The saved Report can be found under the "Reports" tab. The Report can be viewed, modified and reprinted at any time. See "The "Reports" Tab" on page 2-14 for more information.

A Sample Bone Exam Report

A sample 2-page Bone Exam Report is included here for reference.

5/29/2015 2:17:08 PM
Norland at Swissray
Page 1

W6340 Hackbarth Road Fort Atkinson, WI 53538 USA (888) 741-0413

Name: Lateral, Scan

ID: Lateral1

DOB: 11/2/1950

Sex: Male

Ethnic: Caucasian

Age: 53 years

Height: 67

Weight: 176

L H

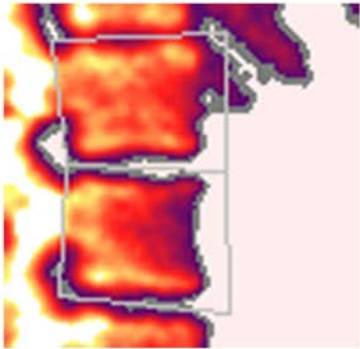

Bone image not for diagnosis.

Lateral Spine on: 10/13/2004 4:20:49 PM



Region	BMD (g/cm ³)	BMC (g)	Area (cm ²)	Length (cm)	Width (cm)	T-Score	Young Ref. (%)	Z-Score	Age Match (%)	ST Change (%)	ST Change (%/yr)	LT Change (%)	LT Change (%/yr)
L2	0.8053	12.26	15.23			*****	*****	*****	*****	*****	*****	*****	*****
L3	0.7372	10.18	13.81			*****	*****	*****	*****	*****	*****	*****	*****
L2 - L3	0.7729	22.44	29.04			*****	*****	*****	*****	*****	*****	*****	*****

STD CV for Vertebra BMD: 2.7 See Guide for other CVs.
1.0 mm X 1.0 mm, 30 mm/s, 10.00 cm, Rev. 4.0.0/2.3.1 Calib. 10/13/04 S/N 8167

Comments:

NORLAND

Figure 10-5: Page 1 of the Bone Exam Report

5/29/2015 2:17:08 PM	Norland at Swissray	Page 2
W6340 Hackbarth Road Fort Atkinson, WI 53538 USA (888) 741-0413		
<p>Name Lateral, Scan</p> <p>Address 123 Oak Street Anytown WI 55555</p> <p>Telephone 222-555-4568</p> <p>History</p> <p>Treatment</p> <p>Medications</p> <p>Comments</p>	<p>ID Lateral1</p> <p>Ethnic Caucasian</p> <p>DOB 11/2/1950</p> <p>Age 53 years</p> <p>Meno Year</p> <p>Sex Male</p> <p>Height 67</p> <p>Weight 176</p>	
<u>Scan Information</u>		
<p>Scan Type: Lateral Spine</p> <p>Analysis Date: 4/4/2005 5:22:37 AM</p> <p>Calibration Date: 10/13/04</p> <p>Technologist: TMD</p> <p>Physician:</p>	<p>Resolution: 1.0 x 1.0</p> <p>Speed: 30 mm/s</p> <p>Width: 10.0</p> <p>Host/Scanner: 4.0.0/2.3.1</p> <p>Analysis/Revision: 4.0.0</p>	
<u>Detailed Results</u>		
NORLAND		

Figure 10-6: Page 2 of the Bone Exam Report

This page intentionally left blank.

CHAPTER 11

Additional Techniques

The Norland Bone Densitometer software has been designed to offer the operator automatic analysis routines. This chapter provides information on creating user-defined regions of interest (special region cursors), tools for enhancing image display, and other utilities for performing non-routine operations.

It also goes into great details about many of the special features of the software, including the Audio feature, FolderMail, Database management and Reference Set management.

This chapter discusses the following.

Adding Audio to a Patient Record	11-2
Using the Voice Note Option	11-3
Using the Audio Dictation Option	11-5
How to Export a Report to PDF	11-7
FolderMAIL	11-9
Database Management	11-14
Working with Reference Sets	11-26
Pressing the Emergency Stop Button	11-37
Special Region Cursors	11-38
Include/Exclude	11-45
Using the Ruler Tool	11-52
Comparison Image	11-54
Image Composition and Image Mode	11-56
Analyzing Saved Scan Data	11-59
Reanalyzing Scan Data	11-61
Changing Height or Weight on the Report	11-62
AP Spine Techniques	11-63
Hip Techniques	11-69
Forearm Analysis Techniques	11-74
Whole Body Scanning Techniques	11-75
Lateral Spine Scanning Techniques	11-76
Research and Small Subject Techniques	11-78

Adding Audio to a Patient Record

The DXA software provides a means for adding the spoken word to a patient record. Audio can be added to a patient record in two ways:

A **Voice Note** is spoken information that is usually specific to the *scan*. Once recorded, the voice note icon  is attached to the thumbnail view of the scan (as seen in the figure on the left).

An **Audio Dictation** is spoken information that is usually associated with the *visit*. The dictation is stored in a separate Audio Dictations tab (as seen in the figure to the right).



Figure 11-1: Voice Note (left) and Audio Dictation (right) icons

IMPORTANT: These procedures assume that the microphone has been installed and the software has been properly set up during installation. The Microphone “Select” check box must be checked for successful recording (see “Installing the Microphone” on page 3-7).

Using the Voice Note Option

As previously mentioned, a **Voice Note** is spoken information that is usually specific to the *scan*.

How to Record a Voice Note

1. Have the microphone nearby, and your thoughts together before starting this procedure.
2. Click to highlight the scan that you want to add a Voice Note to.

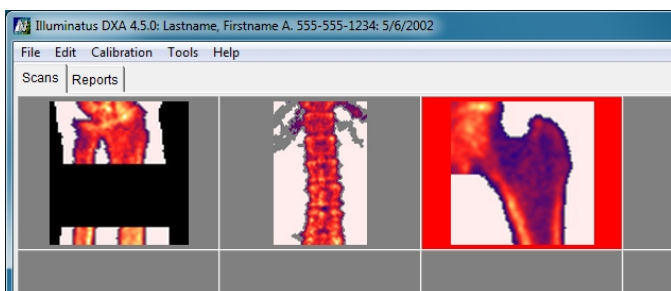

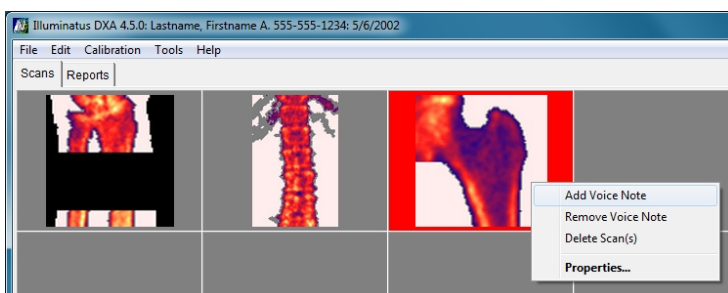

3. Right click the mouse over the scan to open the menu.

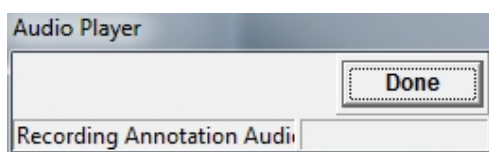

 **Note:** RECORDING BEGINS IMMEDIATELY in the next step.

4. Click on **Add Voice Note** to begin the recording. The Audio Player window pops up and starts recording.

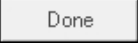

5. Click  to stop recording.
6. The Audio Player window automatically closes and a Speaker icon  appears in the corner of the image where the Voice Note is attached.

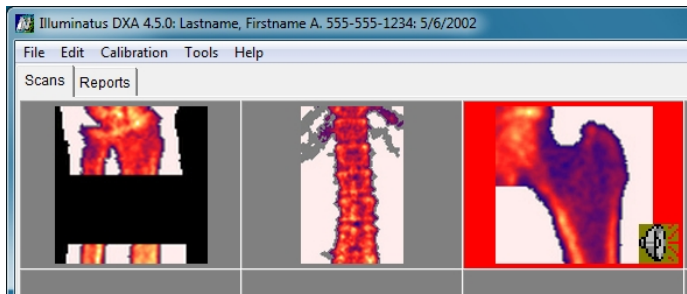

How to Play a Voice Note

Locate the image where the Voice Note is attached and click on the Speaker icon to play the audio clip.

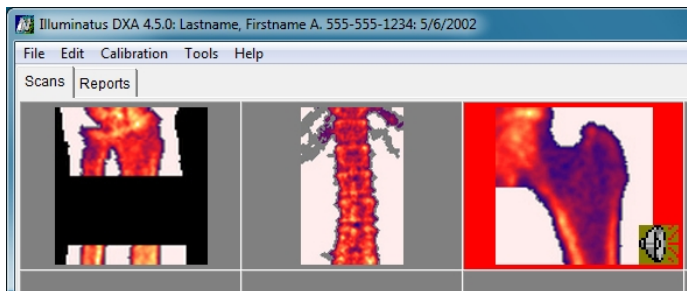

How to Delete a Voice Note

1. Click to highlight the image where the Voice Note is attached.
2. Right click to open the menu and select **Remove Voice Note**.

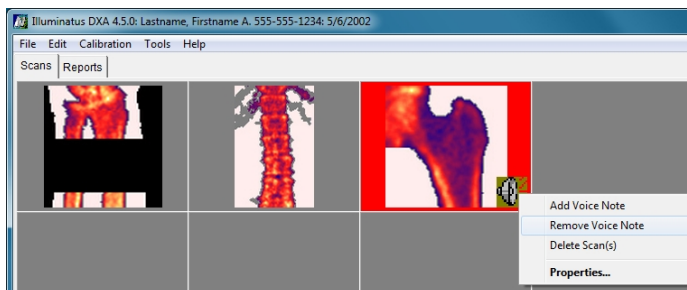

3. The following window pops up, then the Speaker icon will disappear.

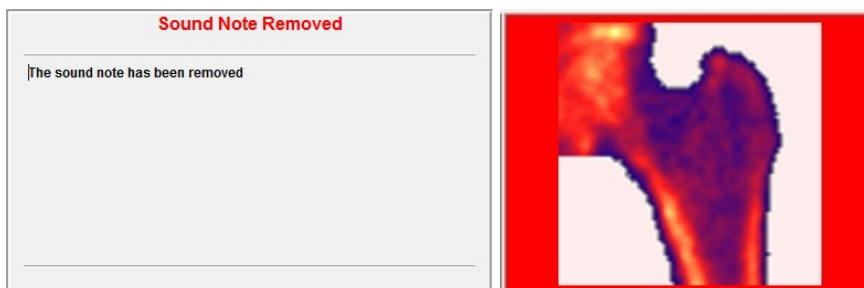



Using the Audio Dictation Option

As previously mentioned, an Audio Dictation is spoken information that is usually associated with the *visit*. The Audio Dictation option enables a person to record anything, including a report dictation pertaining to the selected scan that can be written up later. This Audio file can be sent to a consultant along with the entire patient visit data via FolderMAIL (see "FolderMAIL" on page 11-9). However, Norland software is necessary for viewing, and listening.

Overview of the Audio Dictation Buttons

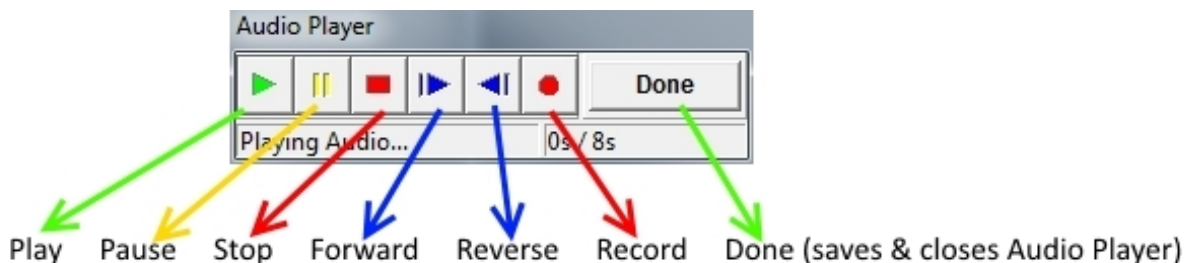
The following image describes the **Audio Player** dialog box buttons:



When an Audio Dictation file is saved (by clicking the  button), it appears as a blue "microphone" icon in the Audio Dictations tab.



How to Record an Audio Dictation

1. Have the visit open in the Stamp View or the Filmstrip View of the software (i.e. click on the Patient Name, Visit Date, Scan type, and then click Stamp View).
2. Have the microphone in place and your thoughts together regarding the information to record. It is advisable to first describe which scan image this Audio Dictation is associated with.

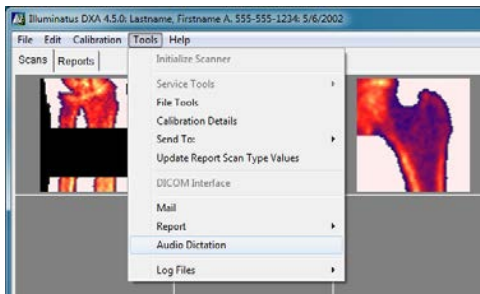

 **Note:** RECORDING BEGINS IMMEDIATELY in the next step.

3. Select **Tools > Audio Dictation**.



4. The **Audio Player** dialog box pops up, and voice recording begins IMMEDIATELY.



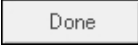



5. Click **Stop**  to stop. Click **Play**  to listen. Click **Record**  to record.
6. Click  when finished recording. The audio dialog box closes and the recording is saved.
7. Notice the addition of a new tab labeled Audio Dictations. Click the tab to see this view.

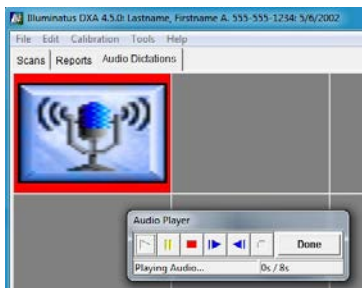

How to Play Back (or Add to) a Recording

1. Double-click on the "Audio" icon  found in the Audio Dictations tab. The recording will begin playing immediately.



- Click **Stop**  to stop. Click **Play**  to listen to the recording. Click **Record**  to add to the recording.
- Click to close the Audio Player dialog box.

How to Delete an Audio Dictation

This operation will permanently delete the audio dictation.

- Select the Audio Dictation tab.
- Click to select the blue “Audio” icon (the background should turn red).



- Right click the mouse over the recording to open the menu. Select **Delete Object(s)**.

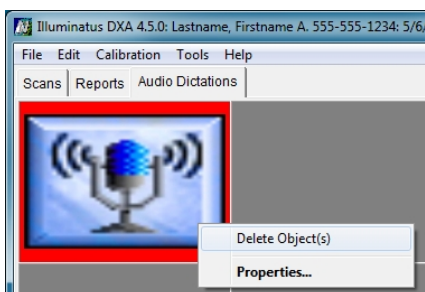

- Click to confirm deletion.

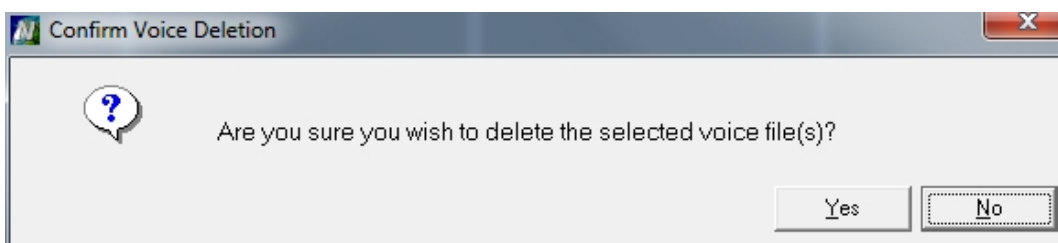

How to Export a Report to PDF

- From the Database Navigator window, select the Patient Name or Patient ID containing the scan(s) to report. Select the Visit Date containing the scan(s).
- Click to open the scan images.

3. The style of report that will be used to create the PDF is shown at the bottom of the screen next to *Report Template*. To change to a different report style, select **Tools > Report > Select Template** or click the

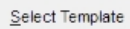
A rectangular button with the text "Select Template" inside.

button, select a new report style, and click

A rectangular button with the text "Done" inside.

4. Select one or two scans (depending on your report type), and click
5. Complete any optional fields in the report preview window.
6. Click
7. Browse to the appropriate directory, type in a file name, and click Save.
8. Close the reporting window when finished.

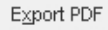
A rectangular button with the text "Report" inside.A rectangular button with the text "Export PDF" inside.

FolderMAIL

FolderMail provides a way for the operator to e-mail all the related data from a patient's *single visit* to a colleague at a remote location for evaluation. The colleague, who must also have the Norland Bone Densitometer windows software, can then work with the data in the same Illuminatus DXA environment. They can analyze the data with all the functionality of the Norland System.

A typical file name for a FolderMAIL attachment is **FolderMAIL_05-28_2004-xxxx-xxxx.iqf**. The recipient can then save the file to disk and rename it with a meaningful, unique name.

The FolderMAIL file includes all the DXA scans selected for that visit date, the patient demographic data, any reports, and any audio dictations associated with that visit.

Requirements

- » To use the FolderMAIL feature, you must have a network connection for the IlluminatusDXA computer available.
- » You must have an SMTP or MAPI mail server available with permissions to send messages.
- » On the receiving computer, you will need a network connection, and an accessible email address to receive the FolderMAIL files.
- » To import the FolderMAIL files, you will need the IlluminatusDXA software installed and a valid license key to operate the software. Workstation licenses are available from Norland.

How to Send FolderMAIL

1. From the Database Navigator window, select the **Visit Date** of the scan image(s) to be e-mailed.

The screenshot shows the 'Patient Visit List' window. At the top, there is a 'Quick Search' section with a 'Category' dropdown menu and a 'Search' text box. Below this is a table with the following columns: Patient ID, Patient Name, Visit Date, Scan Type, and Analyzed. The table contains several rows of data, including patient information and scan details. The 'Visit' row is highlighted in blue.

Patient ID	Patient Name	Visit Date	Scan Type	Analyzed
Fracture	*Spine.fracture			
AP SPINE	*Spine.good			
Off Center	*Spine.off center			
Osteoporotic	*Spine.osteoporotic			
IMPROPER AP	*Spine.poor start/end			
Spine	*Spine.poor condition			
AngleCursors	*Spine.scoliosis			
Too High	*Spine.start too high			
Short	*Spine.too short			
DFWB	*Whole Body			
Gluteus	Abdominal, Soft Tissue			
K10-1111	Adams, Helen			
Dual Hip	Dual, Hip			
K11-6654	JOHNSON, BETTY			
K11-1212	Jones, Mildred			
PatientID	Lastname, Firstname			
Visit		5/6/2002		
Scan			Left Hip	Yes
Scan			AP Spine	Yes
Scan			Left Forearm	Yes
Visit		7/19/2000		
Visit		7/20/1998		
Visit		7/23/1997		
Manual1	Manual, Patient			
Manual2	Manual, Patient			
Manual3	Manual, Patient			
NoSling	No Rotation, Hip			

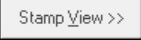
2. Click  to open the scan images. Select **Tools > Mail**.

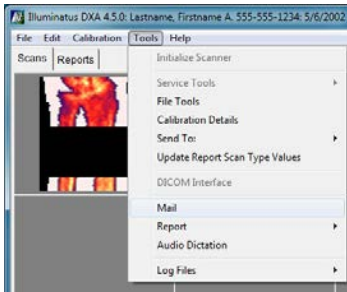

3. Click on the person's name in the *Address book* (who is to receive the FolderMAIL) and click the  button. See "How to Add Names to the Address Book" on page 11-12 for reference, if necessary. If FolderMail is not active, refer to Troubleshooting "FolderMAIL" on page 16-9.

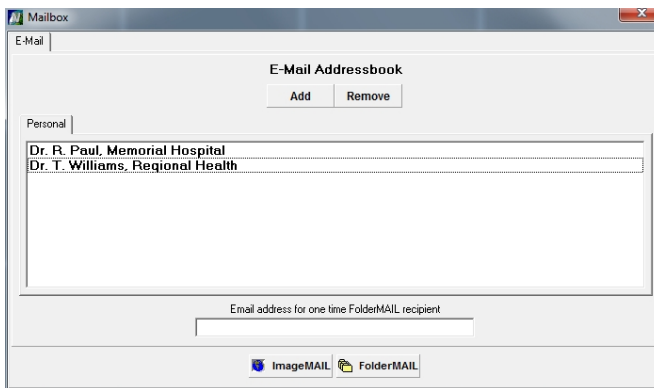

4. Fill in the email Subject and body text to be included in the email message.

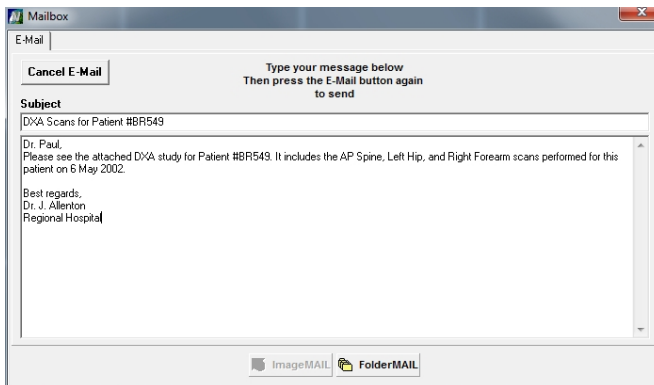

5. Click  again to send the file.

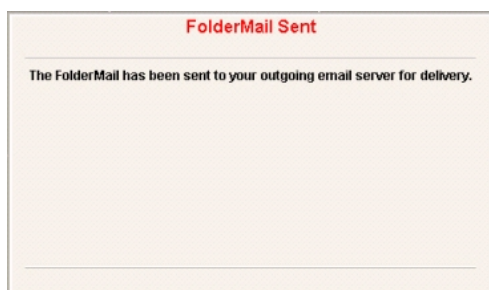

6. The dialog box closes, and the file is sent.

How to Add Names to the Address Book

This procedure explains how to populate the ImageMAIL/FolderMAIL Address Book.

1. From a Stamp (or Filmstrip) View window, click on **Tools > Mail**. The Mailbox window opens.
2. Click the  button. Type the recipients e-mail address in the box. Press the Enter key when done.



3. Type in the name to display for this e-mail recipient. Press the Enter key when done.



4. Notice that the recipients name now appears in the address book.

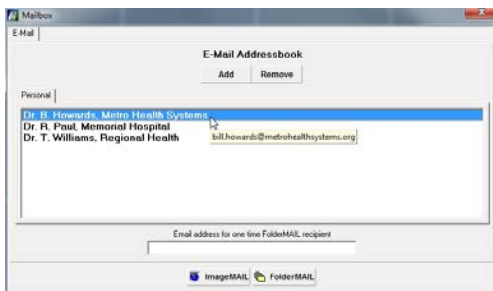

Tip: Click on the Address book name and hover (the pointer) over it to reveal their e-mail address. (Note: name must be highlighted.)

How to Import FolderMAIL to a Database

1. Open your mail program, and the e-mail containing the FolderMAIL attachment (the attachment has a **.iqf** extension).
2. Save the attachment to a folder on your computer. You can rename the file to something meaningful, such as the patient chart number or patient name. Be sure to retain the **.iqf** extension. Make a note of the folder and the attachment file names.
3. From the Database Navigator window, select the Database name where you want to place the imported patient FolderMAIL file.

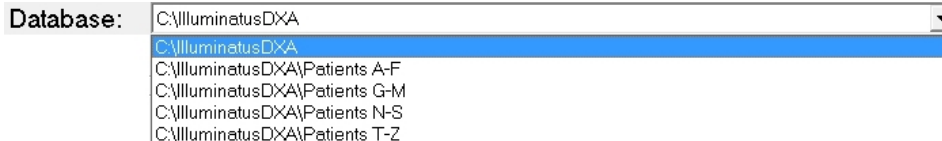

4. Click **File > Import FolderMail...** to open the following dialog box. Browse to the location of your saved FolderMAIL file. Select the filename to import (*AM-23300.iqf* used in the example below) and click

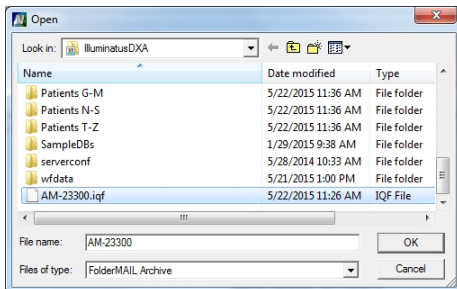

5. The folder and all its contents will quickly be imported. The following dialog box will momentarily flash on the screen to confirm that the action is taking place.

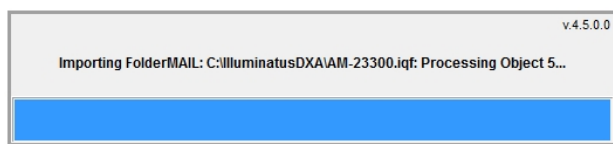

6. Notice the patient's file is now listed in the Database selected in step 1, along with any scans in that folder.

Patient Visit List				
Quick Search:		Category:	Search:	
Patient Name				
Patient ID	Patient Name	Visit Date	Scan Type	Analyzed
[-] PatientID	Lastname, Firstname A.			
[-] Visit		5/6/2002		
Scan			Left Hip	Yes
Scan			AP Spine	Yes
Scan			Left Forearm	Yes

Database Management

The **File > Database** command provides access to all the database functions, including *Add to List* and *Remove from List* of an Active Database, as well as *Create*, *Import*, and *Export*.

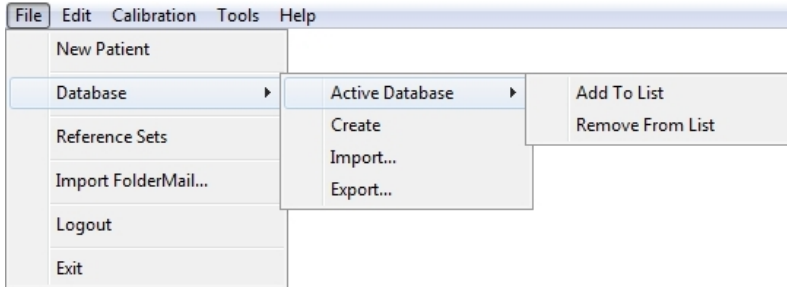

These database commands and procedures are discussed at length in this section.

Creating a Database Folder	11-15
Active Database > Remove From List	11-16
Active Database > Add to List	11-17
Importing a Database	11-18
Exporting a Database	11-20
Deleting Patient Files and Scan Files	11-22
Deleting a Patient File	11-22
Deleting a Patient Visit	11-23
Deleting a Scan Image	11-24

Creating a Database Folder

This command will create a new Database folder (a listing) that will appear in the Database Navigator drop-down list. You must enter a unique name. Once created, it becomes available in the Database Navigator window.

1. Click **File > Database > Create**.

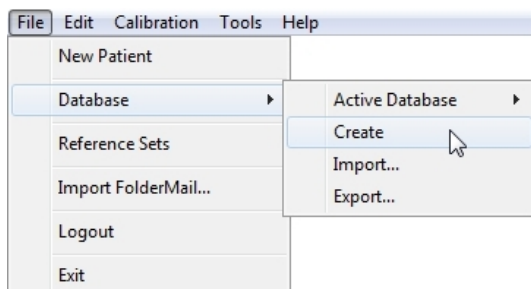

2. Type in a name for the new database folder ("*New Study Database*" was used in this example).

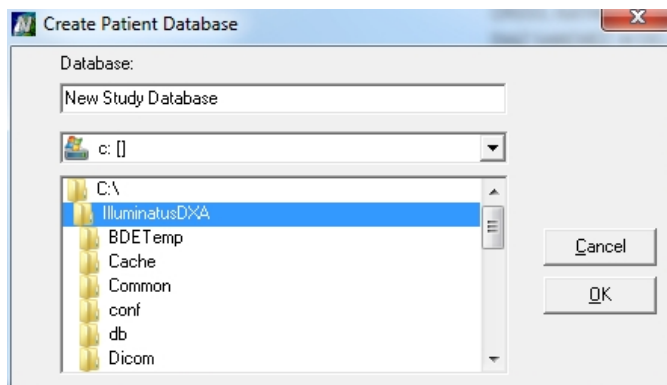

3. Click . The following window pops up confirming the *New Study Database* listing was successfully created.

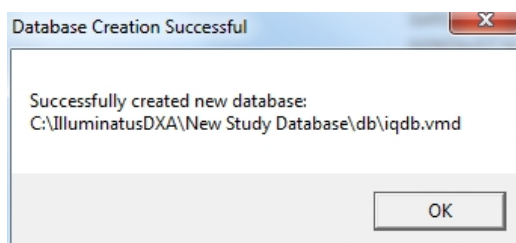

4. Click . The pop-up closes, and the Database Navigator window immediately updates to include the newly created Database name.

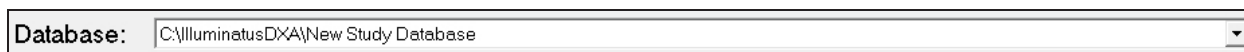

5. From here, you can begin to enter a new patient's information, or Import existing data.

Active Database > Remove From List

This command will remove the selected database from the database list in the Database Navigator window. The database will, however, remain on the hard drive.

1. Click **File > Database > Active Database > Remove From List**.

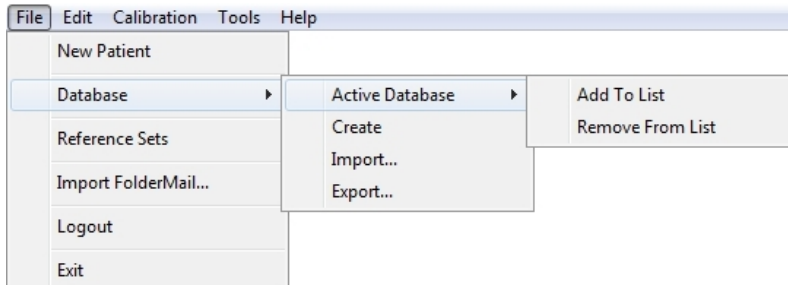

2. Click the drop-down arrow to view all the Databases in the list, and select the Database folder to be removed.

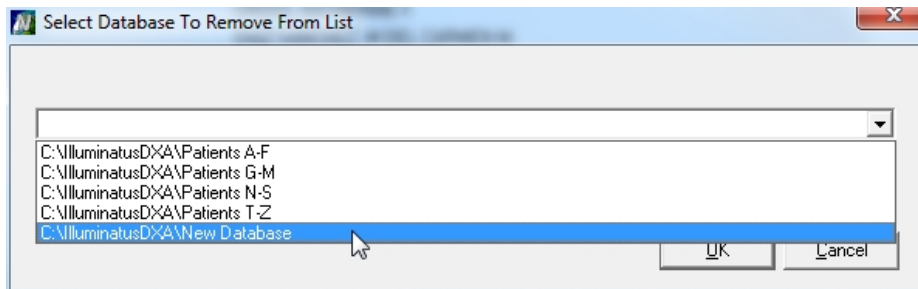

3. Click .
4. When the following dialog box pops up, click or .

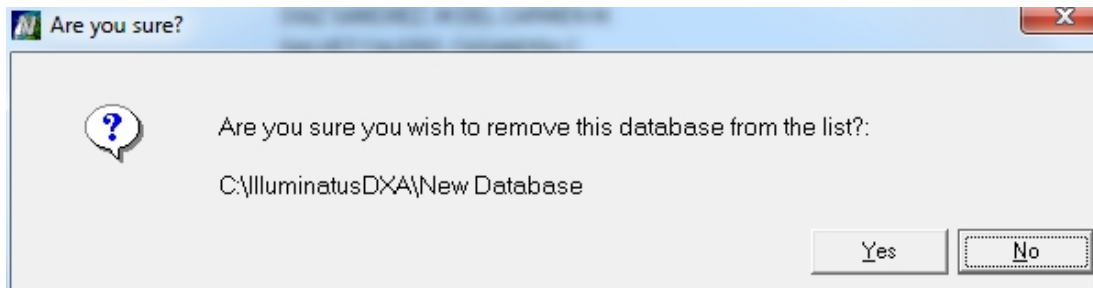

Active Database > Add to List

This command adds an existing database name to the drop-down list in the **Database Navigator** window (see figure below). Upon completion, it becomes the active database in the Database Navigator window. The database of interest **must** have been created using the Norland Windows-based software.

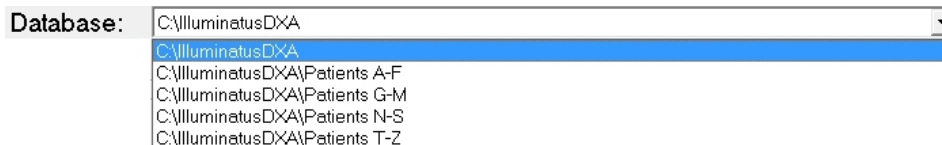

The “**Add to List**” command is used when the Database of interest was previously removed from the drop-down list (but not deleted from the hard drive) and the operator wants to restore it.

1. Click **File > Database > Active Database > Add to List**.

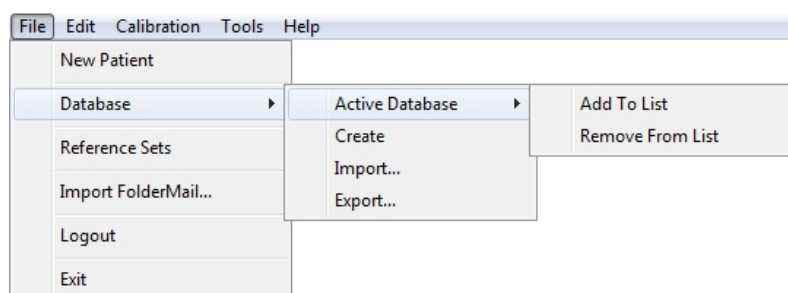

2. In the **Open Patient Database** window, scroll down to locate the folder name of the Database being added to the list.
3. Double-click on the folder to select it and write it to the path above the white box in the window.

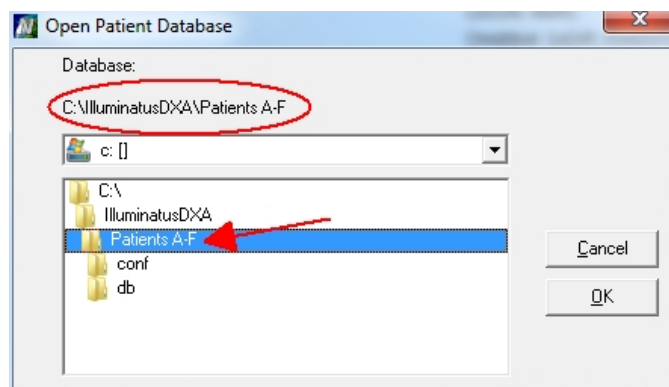

4. Click . Notice that the Database becomes active in the **Database Navigator** window.

Importing a Database

This command imports Patient Files from a Norland DOS system or scans imported from Illuminatus, and adds them to the currently selected Database.

1. Make sure you have created and highlighted a database folder with a unique name, as shown below. Here, *New Study Database* is used in the example.

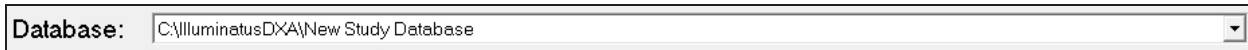

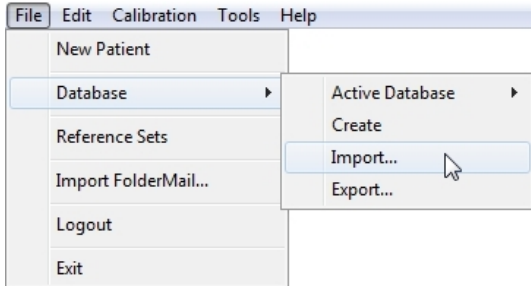

2. Click **File > Database > Import**.

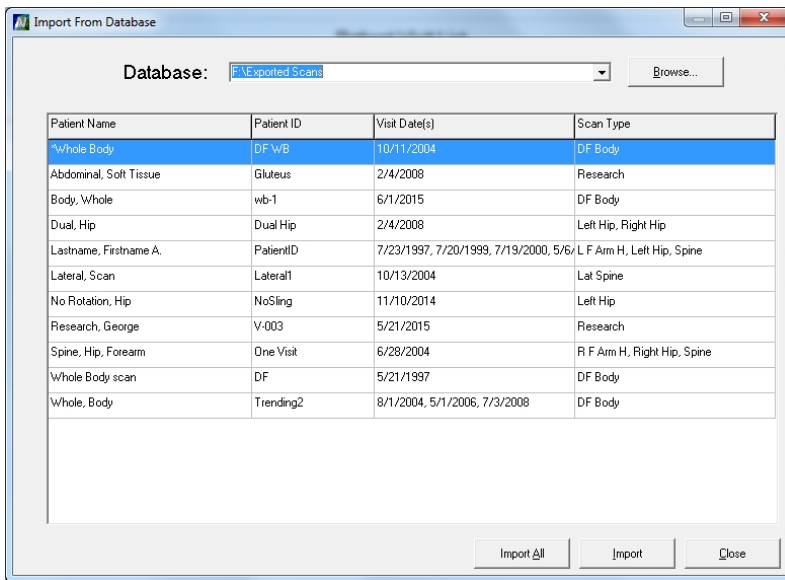

3. Browse to (or type) the location of the files (to be imported) into the box labeled **Database**. In this example, the path *F:\Exported Scans* is used. All the files in that location are now listed in the window.



4. To import all patients listed, click . To import only selected patients, highlight the patient(s) you want to import and click . Additional patients may be selected and imported until all required patients have been imported.
5. When the import is complete, a success message will be temporarily displayed.

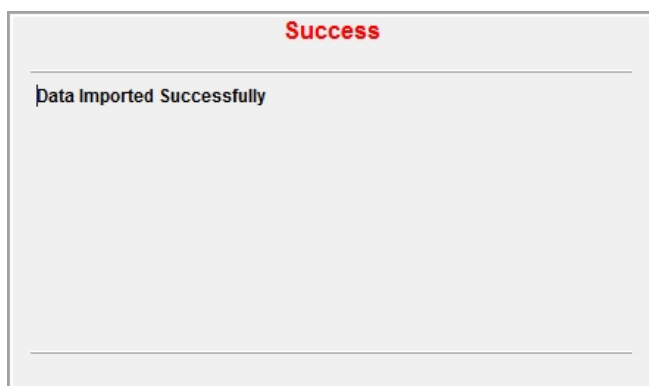

6. When complete, click .
7. The imported patient scans now appear in the Database selected in step 1.

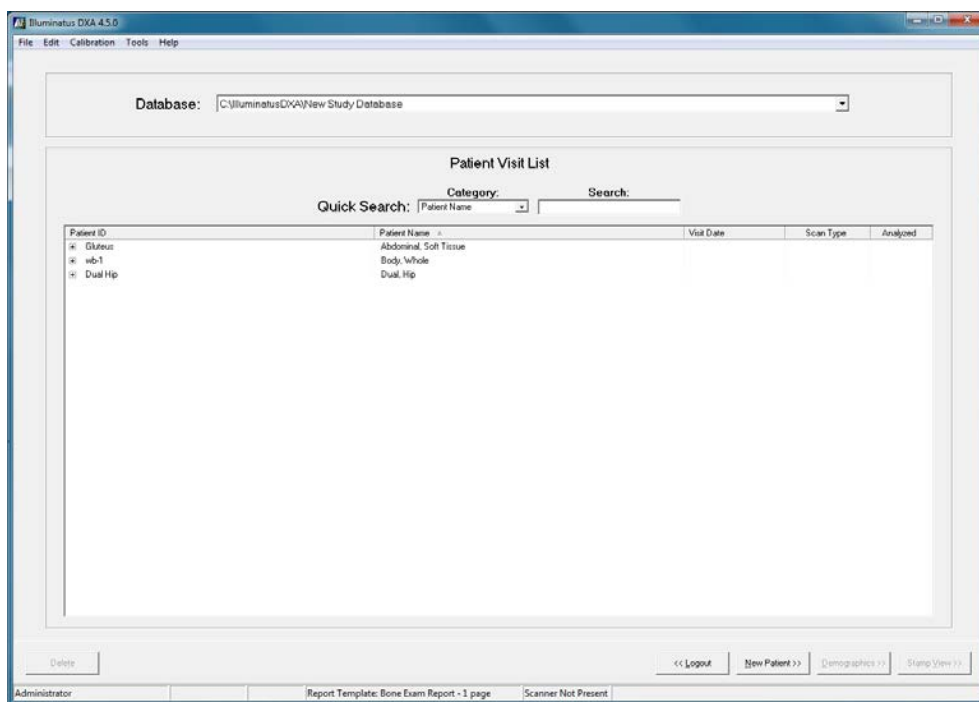

Exporting a Database

This command exports an entire database, selected patient files inside a database, a single patient file, or the scans from a single patient visit. You can export to a previously created folder on the hard drive or any accessible drive letter and path.

- In the Database Navigator window, select the record(s) to be exported (it must be highlighted). A minimum of one record must be selected to open the Export tool.
 - » Single click on the Patient name to *export the entire patient record*.
 - » Single click on the *individual Visit Date* of interest under the patient's name.
 - » Hold the <Shift> key and click the *consecutive names of the patients* you want to export.
 - » Hold the <Ctrl> key and click *only the patient names* you want to export in the database.
- If necessary, create a destination folder on the destination drive. The folder "F:\Exported Scans" is used in the example below.
- Click **File > Database > Export**.

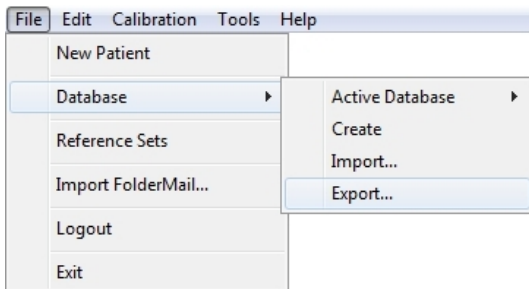

- Click and browse to the desired drive and folder.

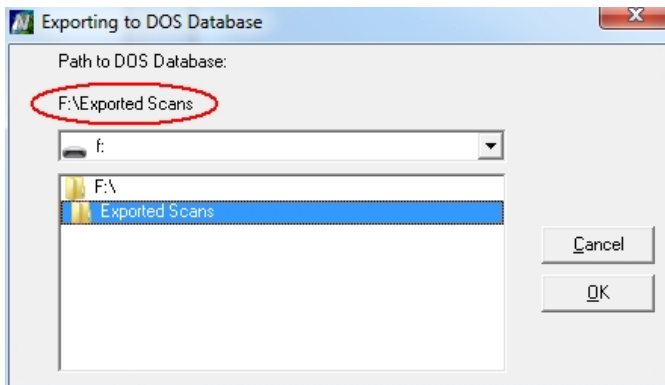

- When the destination location is selected, click .
- To export only the selected patient(s) or visit(s), click . To export all of the patients and visits from the current database, click .
- When the export is complete, a success message will be temporarily displayed.



8. The files that were successfully exported now appear in the Export to Database window, along with the visit dates selected (multiple names appear, if more than one name was selected).

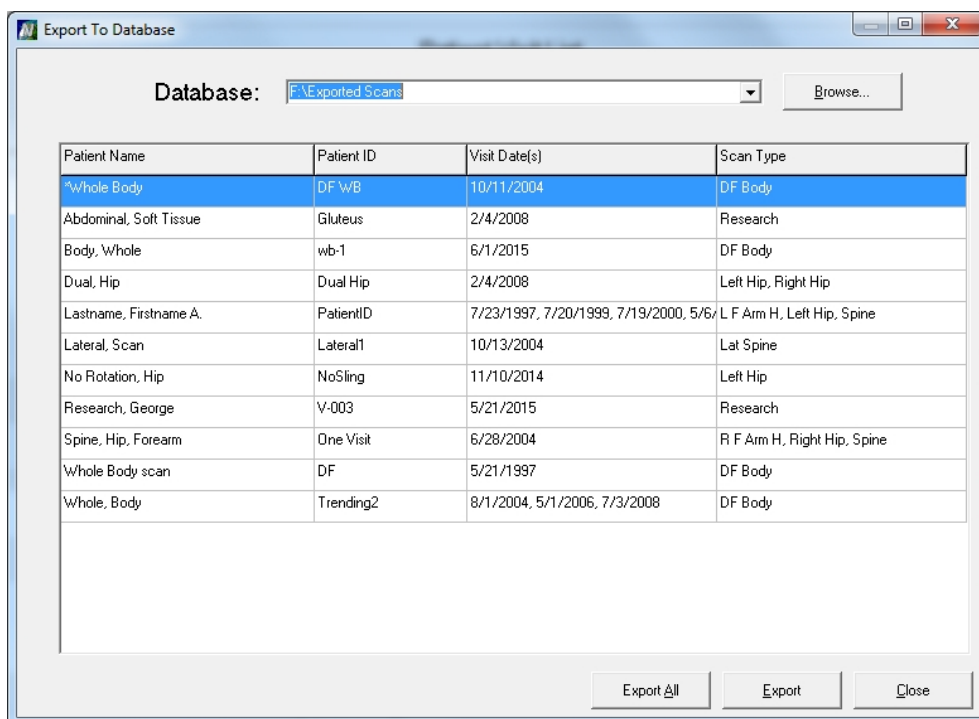

9. Click Close to return to the Database Navigator window.



Note: For subsequent export procedures, you can click the drop down arrow in step 4 and select an existing folder instead of clicking Browse to export to the same location.

Deleting Patient Files and Scan Files

When duplicate scans or unsatisfactory scans exist, trending analysis is hampered. *Patients*, *Visits*, or individual *Scans* can be deleted. There is NO undo for the Delete function.

Deleting a Patient File



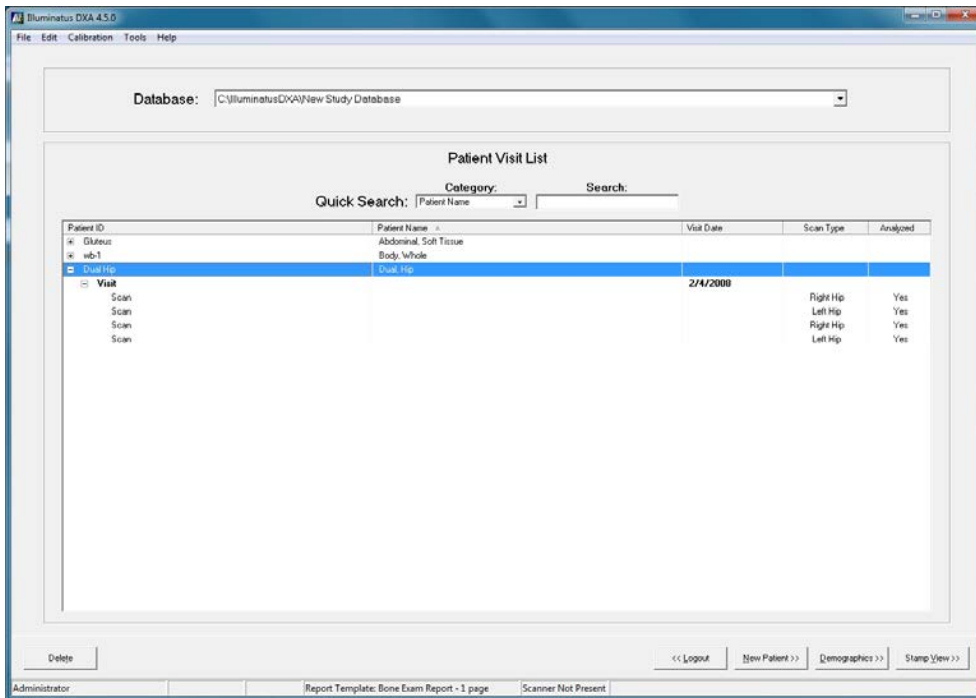

Caution: Deleting a *patient* record will delete all the associated scan data files that go with that patient. Deletions cannot be undone.

1. Select the patient from the Patient Visit List to be deleted. Only one patient can be deleted at a time.

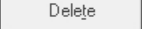

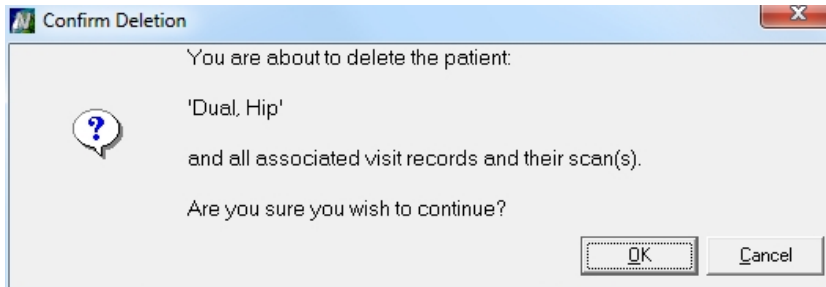
2. Click the  button at the bottom of the window.
3. A confirmation dialog box will be displayed.



4. Click on  to delete the entire patient record (remember, there is NO undo).
5. The selected patient file will be deleted from the database.

Deleting a Patient Visit



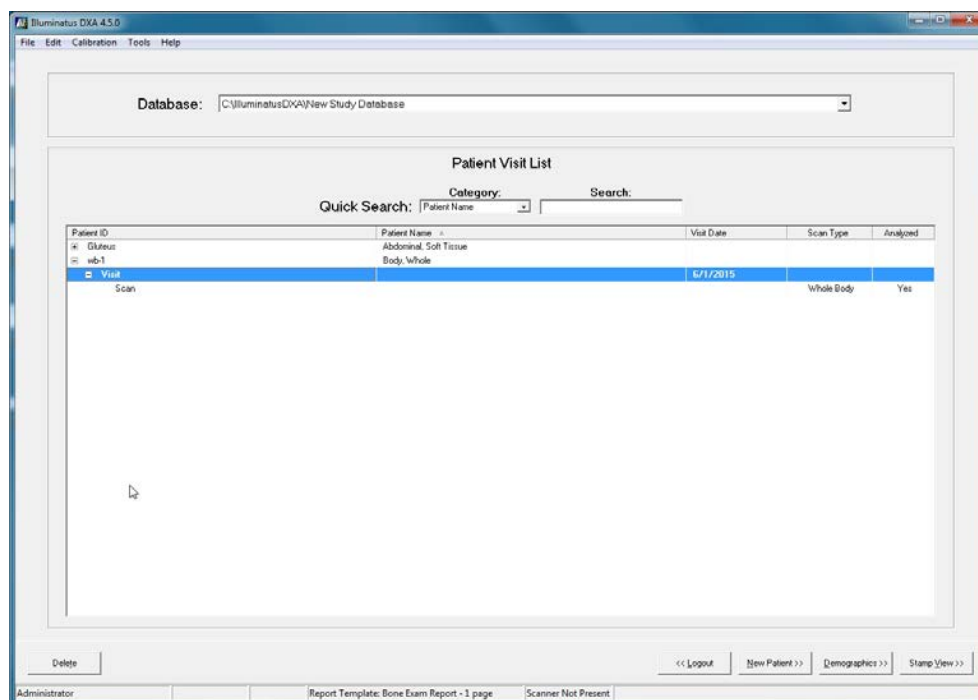

Caution: Deleting a *visit* from a patient record will delete all the associated scan data files that go with that visit. Deletions cannot be undone.

1. Click on the patient's visit scan date (in the Database Navigator window) that is to be deleted.

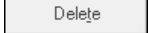

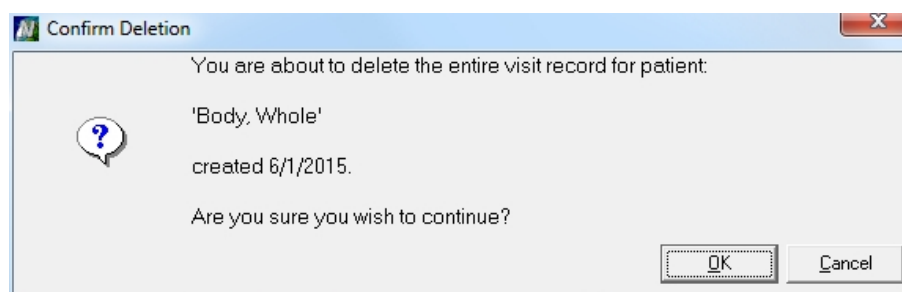
2. Click the  button at the bottom of the window.
3. A confirmation message will be displayed.



4. Click on  to delete the visit record (remember, there is NO undo).
5. The selected patient visit will be deleted from the database.

Deleting a Scan Image



Caution: Deleting a *scan* from a patient visit cannot be undone.

1. From the Database Navigator window, select the visit or scan record of the scan image to be deleted (i.e. select the Patient Name, Visit Date, and Scan Type).

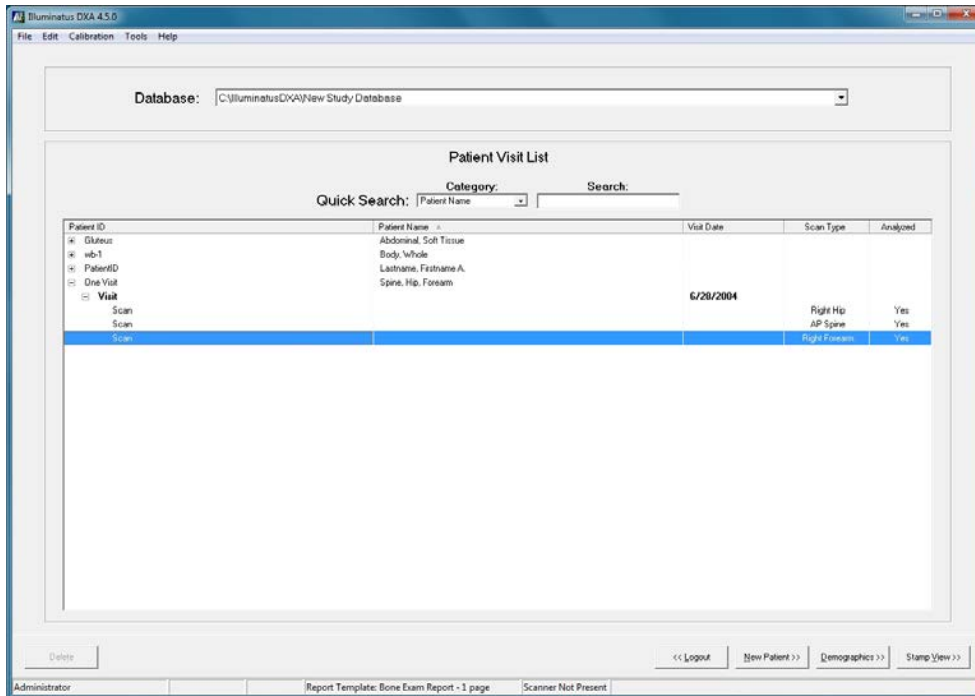

2. Click on **Stamp View >>** to open the Scans tab window.
3. Highlight the scan (or scans) to be deleted. (Hold the <Ctrl> key to select more than one scan.)
4. Right click to reveal a menu. Select Delete Scan(s).

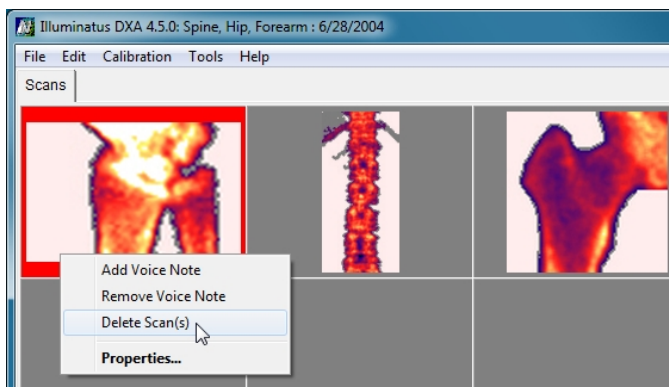

5. A confirmation message will be displayed.

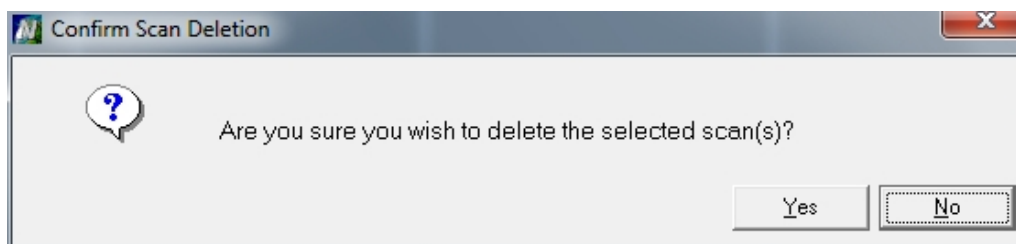

6. Click on to delete the scan(s) (remember, there is NO undo).
7. The selected scan will be deleted from the database.

Working with Reference Sets

The “Reference Sets” are accessed by clicking **File > Reference Sets**. These Reference Sets are installed on the hard drive during installation. The Reference Set command provides some tools for maintaining and creating Reference Sets on the system.

 **Note:** Printed Norland supplied “Reference Set Data Sheets” are located in Chapter 18, Reference Data Sets. Chapter 18 also describes the source of the data and explains the information gathering criteria.

The Reference Sets window (shown below) displays a list of currently available Reference Data sets.

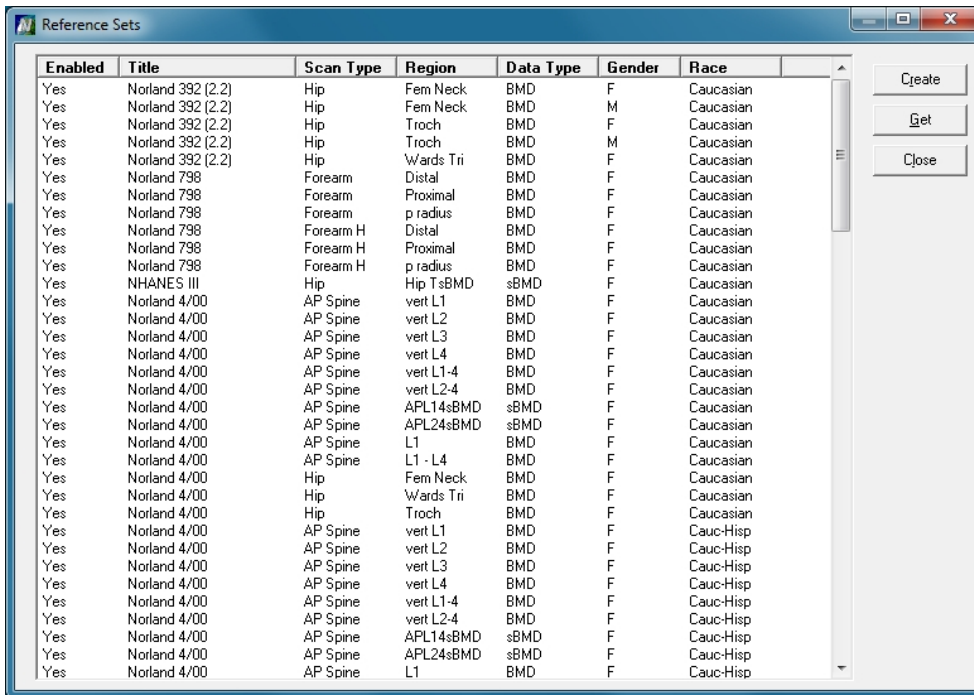

Enabled	Title	Scan Type	Region	Data Type	Gender	Race
Yes	Norland 392 (2.2)	Hip	Fem Neck	BMD	F	Caucasian
Yes	Norland 392 (2.2)	Hip	Fem Neck	BMD	M	Caucasian
Yes	Norland 392 (2.2)	Hip	Troch	BMD	F	Caucasian
Yes	Norland 392 (2.2)	Hip	Troch	BMD	M	Caucasian
Yes	Norland 392 (2.2)	Hip	Wards Tri	BMD	F	Caucasian
Yes	Norland 798	Forearm	Distal	BMD	F	Caucasian
Yes	Norland 798	Forearm	Proximal	BMD	F	Caucasian
Yes	Norland 798	Forearm	p radius	BMD	F	Caucasian
Yes	Norland 798	Forearm H	Distal	BMD	F	Caucasian
Yes	Norland 798	Forearm H	Proximal	BMD	F	Caucasian
Yes	Norland 798	Forearm H	p radius	BMD	F	Caucasian
Yes	NHANES III	Hip	Hip TsBMD	sBMD	F	Caucasian
Yes	Norland 4/00	AP Spine	vert L1	BMD	F	Caucasian
Yes	Norland 4/00	AP Spine	vert L2	BMD	F	Caucasian
Yes	Norland 4/00	AP Spine	vert L3	BMD	F	Caucasian
Yes	Norland 4/00	AP Spine	vert L4	BMD	F	Caucasian
Yes	Norland 4/00	AP Spine	vert L1-4	BMD	F	Caucasian
Yes	Norland 4/00	AP Spine	vert L2-4	BMD	F	Caucasian
Yes	Norland 4/00	AP Spine	APL14sBMD	sBMD	F	Caucasian
Yes	Norland 4/00	AP Spine	APL24sBMD	sBMD	F	Caucasian
Yes	Norland 4/00	AP Spine	L1	BMD	F	Caucasian
Yes	Norland 4/00	AP Spine	L1 - L4	BMD	F	Caucasian
Yes	Norland 4/00	Hip	Fem Neck	BMD	F	Caucasian
Yes	Norland 4/00	Hip	Wards Tri	BMD	F	Caucasian
Yes	Norland 4/00	Hip	Troch	BMD	F	Caucasian
Yes	Norland 4/00	AP Spine	vert L1	BMD	F	Cauc-Hisp
Yes	Norland 4/00	AP Spine	vert L2	BMD	F	Cauc-Hisp
Yes	Norland 4/00	AP Spine	vert L3	BMD	F	Cauc-Hisp
Yes	Norland 4/00	AP Spine	vert L4	BMD	F	Cauc-Hisp
Yes	Norland 4/00	AP Spine	vert L1-4	BMD	F	Cauc-Hisp
Yes	Norland 4/00	AP Spine	vert L2-4	BMD	F	Cauc-Hisp
Yes	Norland 4/00	AP Spine	APL14sBMD	sBMD	F	Cauc-Hisp
Yes	Norland 4/00	AP Spine	APL24sBMD	sBMD	F	Cauc-Hisp
Yes	Norland 4/00	AP Spine	L1	BMD	F	Cauc-Hisp

Figure 11-2: The Reference Sets Data Table

To Create a Reference Set	11-27
To Get a Reference Set	11-29
To Edit a Reference Set	11-31
To Delete a Reference Set	11-32
To Send a Reference Set	11-33
To Print a Reference Set	11-34
Reference Set Selection	11-35

To Create a Reference Set

Reference sets can be created for local populations. The Create Reference Set feature allows the operator to input reference data from a printed copy or from a statistical analysis of a local population.

The operator is able to select the scan type and the region for which the reference set is being created. For each scan type, the region pull-down menu has an option labeled “Other”. When this option is selected, the “User Defined” edit field determines the region name.

Note that the operator is allowed to create reference sets for multiple user defined regions for a given scan type. Also, for the same scan type and region name, multiple reference sets can be created with different titles. In the case of the *Small Subject* scan type, you will note that when you click on Small Subject, the “Small Subject” checkbox in the Research group box is checked as active.

This section explains how to create a Reference Set.

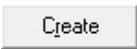
1. Click on **File > Reference Sets** to open the Reference Set window.
2. Click on  to open the Create Reference Set dialog box.

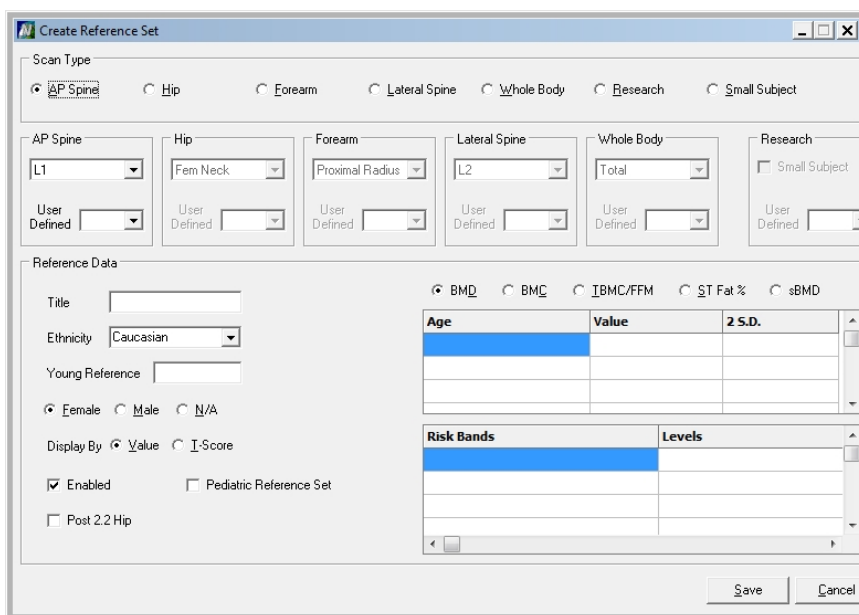

3. Click on a *Scan Type* radio button according to the type of Reference Set being created (“*Whole Body*” is used in this example).
4. Click the drop-down arrow to select and define a scan region (*Total* used here). The box labeled *User Defined* would be a special region designed by the operator.

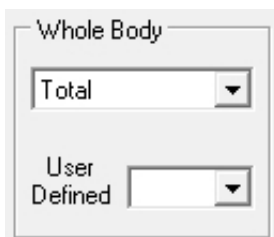

5. Continue to enter data for each of the fields and make appropriate selections in the Reference Data area of the window. Select *Pediatric Reference Set* only if the set is being created for patients younger than twenty years old. The *Title* entered in the box will appear at the top of the Reference Graph. A sample Reference Set is reproduced below for reference.

Create Reference Set

Scan Type
 AP Spine Hip Forearm Lateral Spine Whole Body Research Small Subject



AP Spine: L1
 Hip: Fem Neck
 Forearm: Proximal Radius
 Lateral Spine: L2
 Whole Body: Total
 Research: Small Subject

Reference Data
 Title: Dudley
 Ethnicity: Caucasian
 Young Reference: .979
 Female Male N/A
 Display By: Value I-Score
 Enabled Pediatric Reference Set
 Post 2.2 Hip

Age	Value	2 S.D.
20	.979	.2
50	.919	.2
80	.671	.2

Risk Bands: [Empty]
 Levels: [Empty]

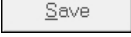
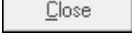
Save Cancel

6. Click  and then  to enter the newly created Reference Set into the database.
7. Click  to close the Reference Sets window.

To Get a Reference Set

The *Get* feature allows the user to load Reference Sets from an existing Reference Set file to the current Reference Set file.

1. Click on **File > Reference Sets** to open the Reference Sets window.

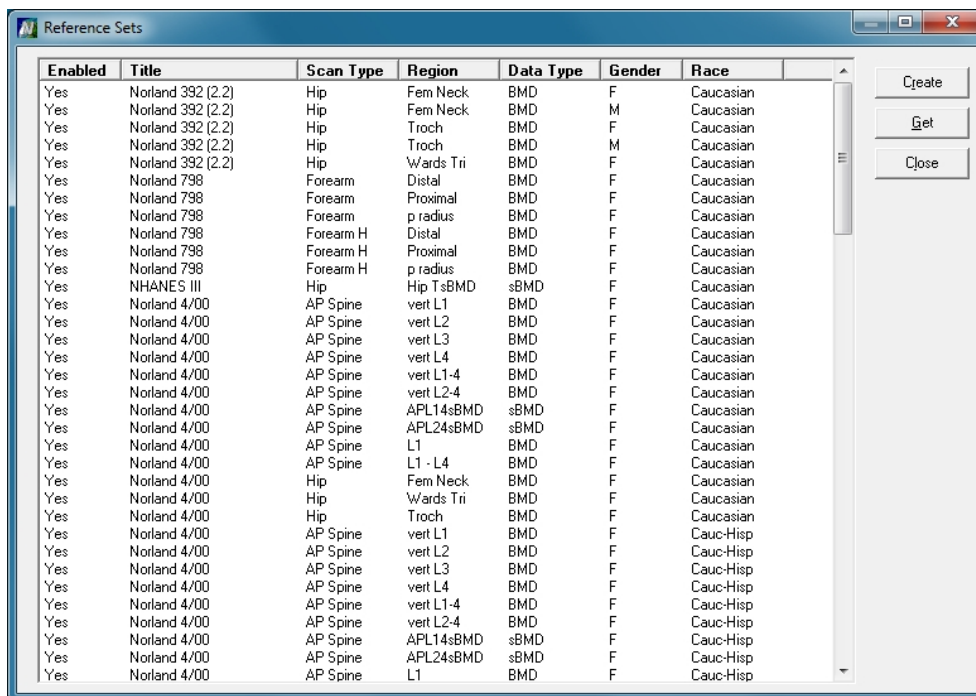

2. Click on to open the file selection window.

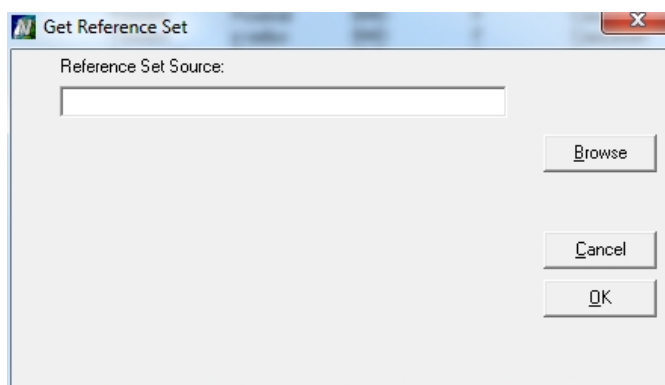

3. Specify the file that the Reference Sets are to be gotten from by typing in the full path of the file or by selecting the file using the browser.
4. Click to open the file and list its contents.

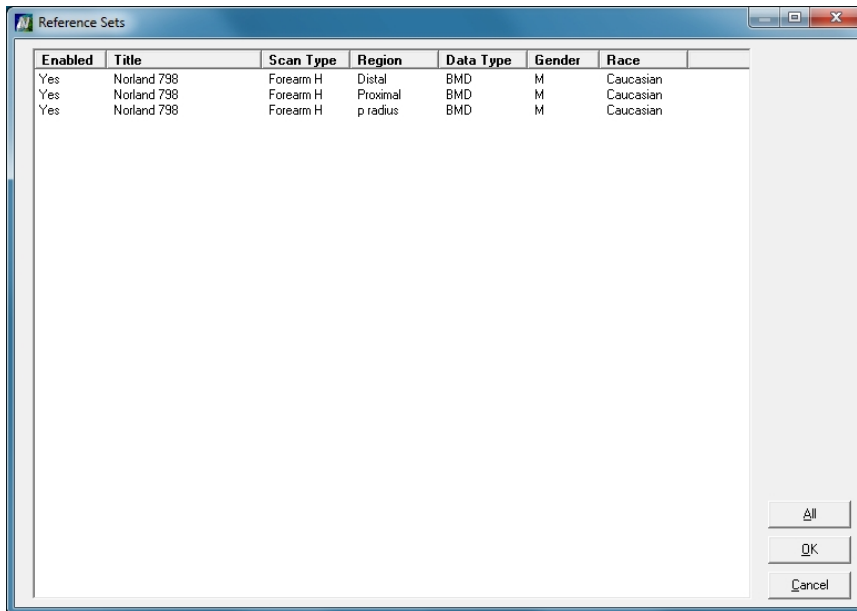

5. There are four choices for selecting References:

- a. to select all of the References in the set, click , or
- b. to select an individual Reference, highlight it and click , or
- c. to select multiple References, press the <Ctrl> key to highlight the desired References and click , or
- d. to select a group of References, click on the first desired Reference, press <Shift> and click on the last to highlight the group and click .

6. These options will merge the new Reference Sets with the existing ones.

7. Click to finish.

To Edit a Reference Set

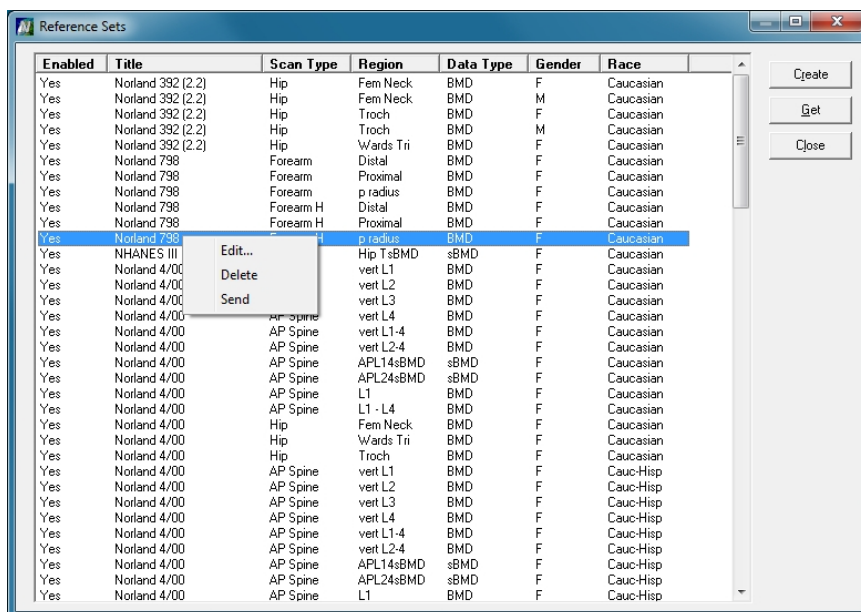

The *Edit* feature allows installed Reference Sets to be edited. In addition, Reference Sets can be enabled and disabled through the Edit window.

1. Click on **File > Reference Sets** to open the Reference Sets window.
2. Highlight the Reference Set to be edited, then right click on it.
3. Click *Edit...*

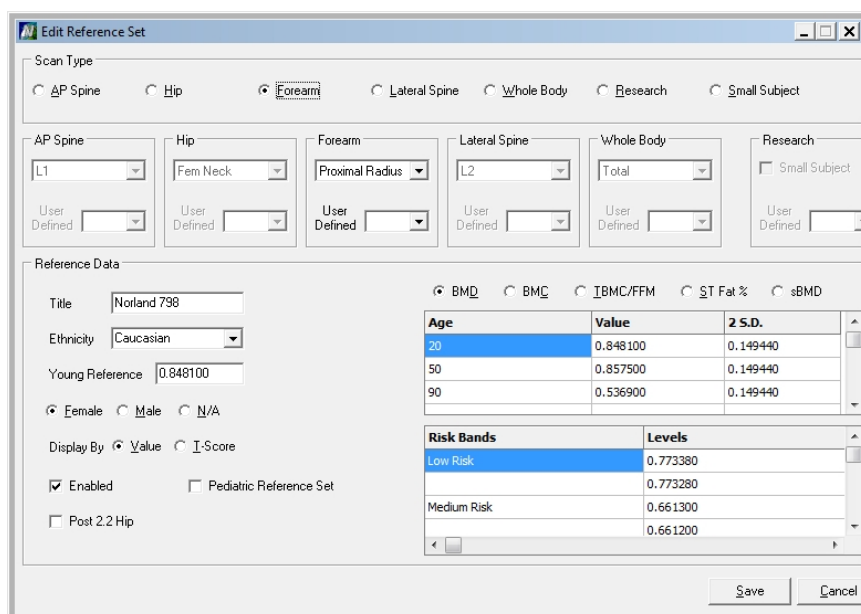

4. When the Edit window opens, make the necessary edits. Notice that the Reference Set can also be *Enabled* or *Disabled* here by clicking the Enabled check box. Clicking this check box will enable the Reference Set to be used in a graph or to calculate T-Scores/Z-Scores.

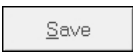

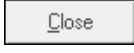
5. When done editing, click .
6. Click  to close the Edit window.
7. Confirm that the change was made to the edited Reference Set. Click  to close the Reference Sets window.

To Delete a Reference Set

The *Delete* feature allows installed Reference Sets to be deleted from the system. The deletion cannot be undone.

1. Click on **File > Reference Sets** to open the Reference Sets window.
2. Locate and click to highlight the Reference Set(s) to be deleted.
 - » To select an individual Reference Set, click on it.
 - » To select multiple References, press the <Ctrl> key and click on the desired References.
 - » To select a group of References, click on the first desired Reference, press <Shift> and click on the last to highlight the group.
3. Right click on the highlighted record(s) to open the “Edit/Delete/Send” pop-up.
4. Click on *Delete* (remember, this cannot be undone). The Reference will be deleted from the list.

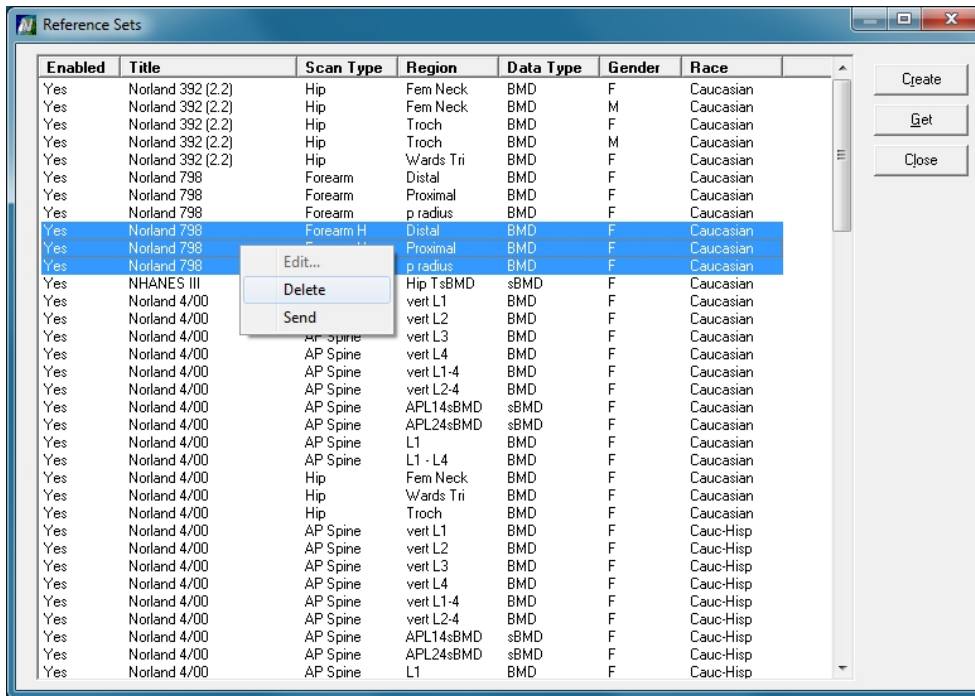

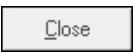
5. Click  to close the Reference Sets window.

To Send a Reference Set

The *Send* feature allows a user to export a Reference Set from the current Reference Set file to a user defined Reference Set file which may be shared with other users. The Send function does not remove the Reference Set from the current Reference Set file.

1. Click on **File > Reference Sets** to open the Reference Sets window.
2. Locate and click to highlight the Reference Set(s) to be sent.
 - » To select an individual Reference Set, click on it.
 - » To select multiple References, press the <Ctrl> key and click on the desired References.
 - » To select a group of References, click on the first desired Reference, press <Shift> and click on the last to highlight the group.
3. Right click on the highlighted record(s) to open the “Edit/Delete/Send” pop-up.
4. Click on *Send*.

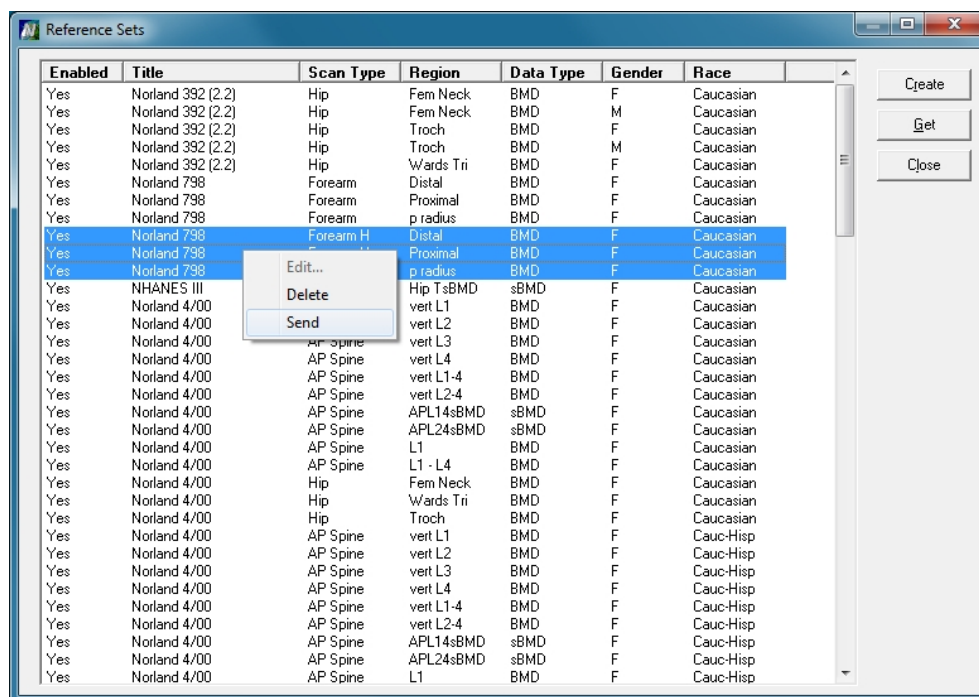

5. Specify the file the Reference Sets are to be sent to by typing in the full path of the file or by selecting the file using the browser.
6. Click to send the Reference Set(s).
7. Click to finish.

To Print a Reference Set

1. A Reference Set can be printed by selecting **Tools > File Tools**.
2. Click on the **Normals** tab.

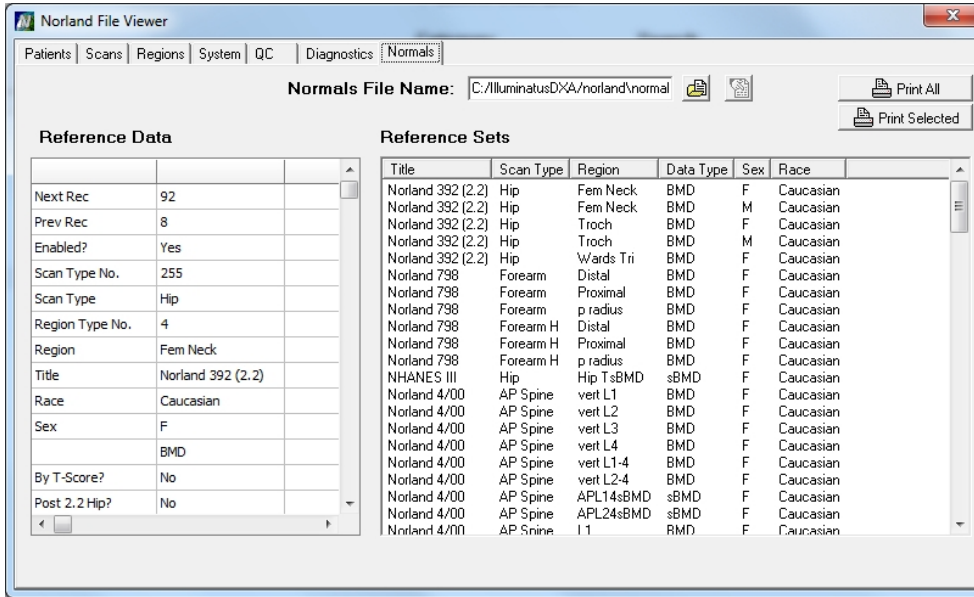

3. To print one Reference Set, click on the Reference Set of interest to select it and then click on the **“Print Selected”** button.

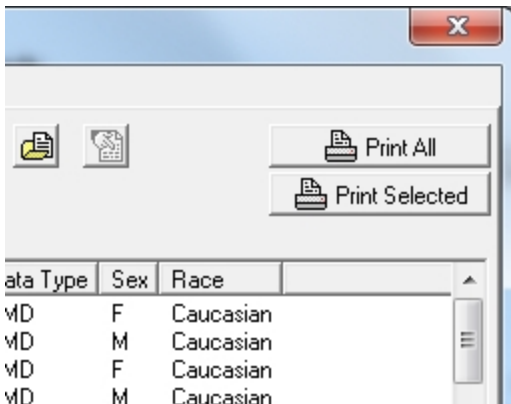

4. To print all the Sets, click on the **“Print All”** button.

Reference Set Selection

After a scan has been performed and analyzed, the reference sets corresponding to the patient's demographic data are loaded automatically. However, if matching reference sets could not be found, the user is prompted to select which reference sets are used.

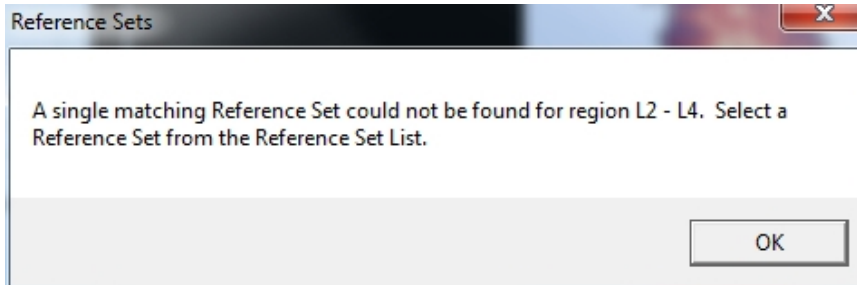

The user may then select any of the available reference sets available for the scan type by clicking on it and then clicking . Click if no reference sets are desired.

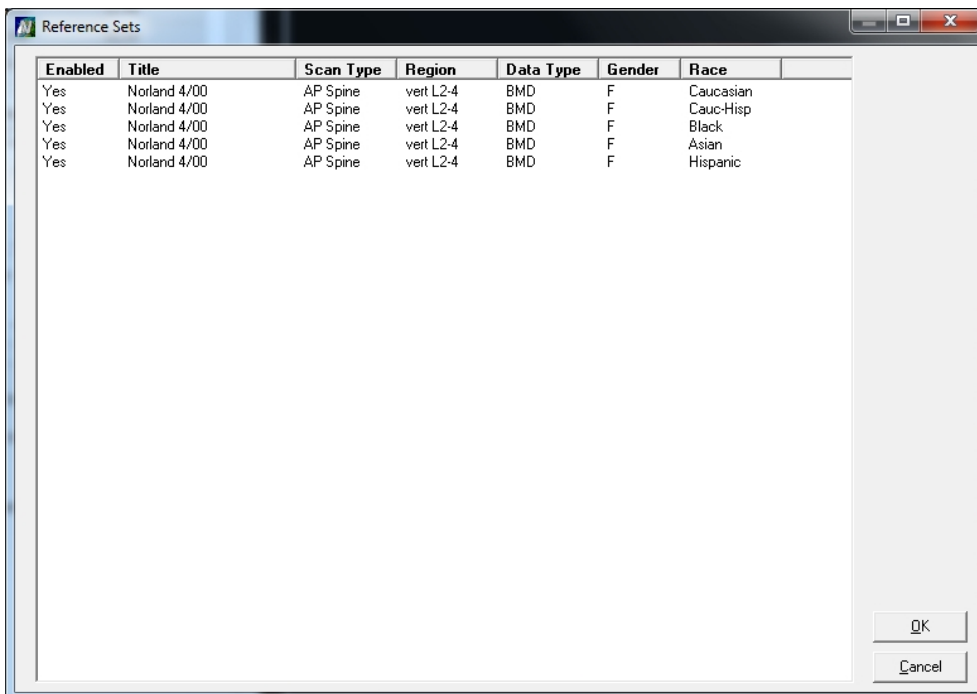

The reference sets selected are used for all subsequent viewings of the scan and the reports generated for the scan. To change the reference sets being used for the scan, right click on the image while in the Scan Results tab window. Select *Change Ref Sets* from the *Graphs* menu.

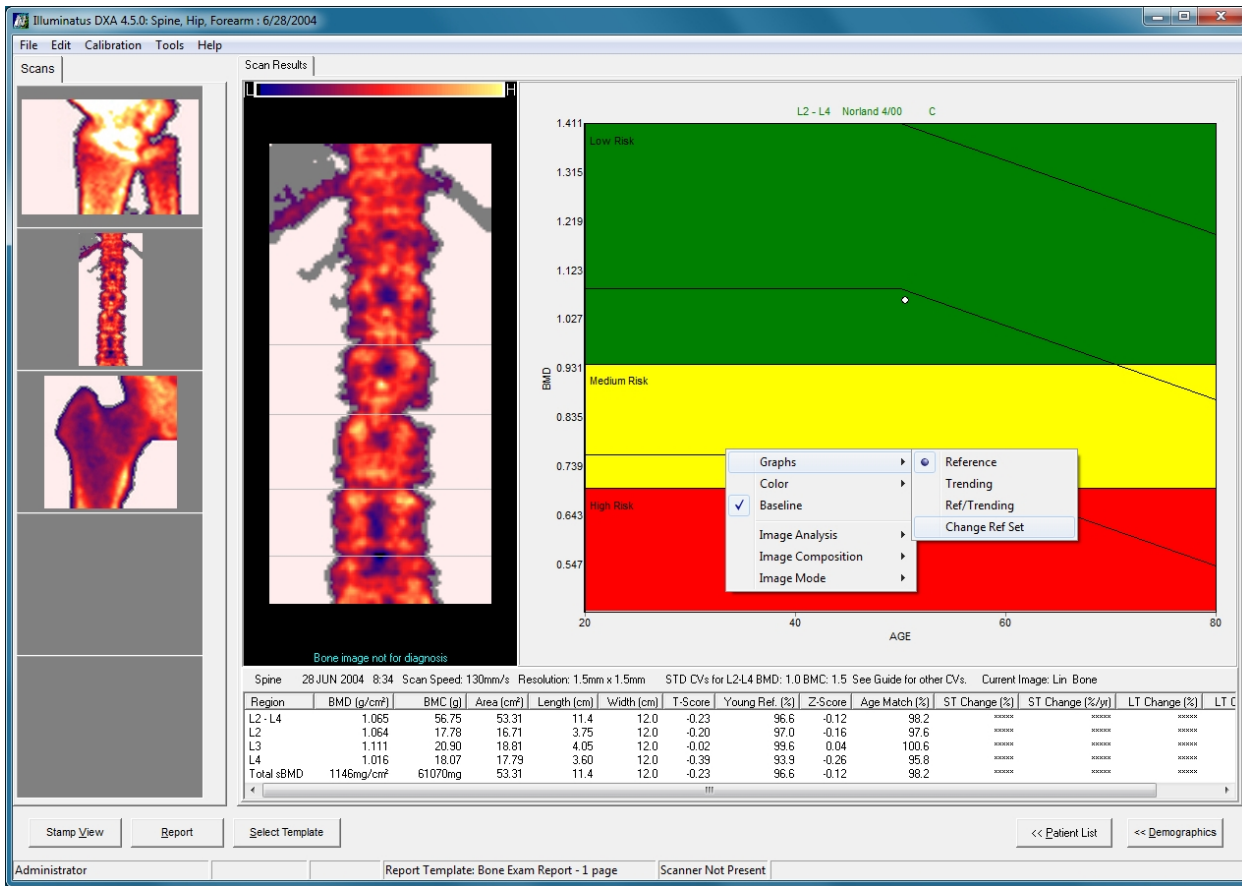

Pressing the Emergency Stop Button



Press the Emergency Stop button directly below the Scanner Arm Touch Pad to immediately terminate the x-ray exposure and stop the scanner arm movement.

After the Emergency Stop button has been pressed, you must twist the Emergency Stop switch to release it, then turn the scanner power switch OFF and back ON again to resume scanning.



Caution: When the scanner power switch is turned back on, the scanner arm will return to its origin position. ENSURE THAT THE PATIENT IS NOT IN THE SCANNER ARM PATH!

From the Tools menu, select Initialize Scanner to reinitialize the scanner.

The following warning will appear:

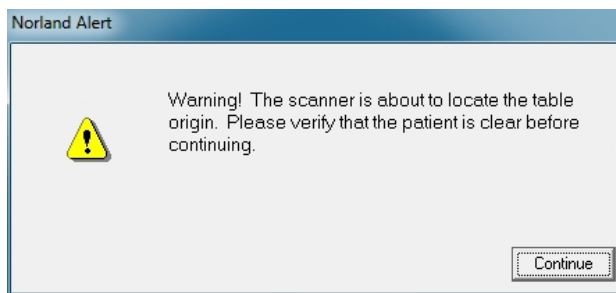

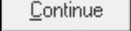
Click  to continue. The scanner arm will find the origin. Leave the computer power switch ON to retain the current study.

Special Region Cursors

Special Region Analysis software estimates bone mineral in operator-defined regions of the DXA scan.

Norland software automatically includes defined special regions when it calculates and presents numeric results, and it saves the cursor placement and size information with the analysis.

Subsequent scans should incorporate the Show Comparison feature to aid in replication of any special region cursors.

Number of Special Regions Permitted

The maximum number of special regions permitted depends on the scan type. The table below lists the maximum number of Special Regions permitted for each Norland scan option.

Table 11-1: Number of Special Regions

Scan Type	Maximum # of Special Regions
AP Spine	2
Left/Right Hip	2
Whole Body ^a	2
Left/Right Forearm ^a	2
Lateral Spine ^a	2
Research ^a	7
Small Subject ^a	7

^aThis scan type is not available on all models.

Add a Special Region

The Special Region analysis process begins with placement of the first cursor box to circumscribe the area of interest. Refer to Table 11-1 on **page 11-38** for the number of special regions allowed per scan type. Be sure to name the regions in a consistent manner with your study protocols.

1. Open the scan of interest in the Analysis tab.

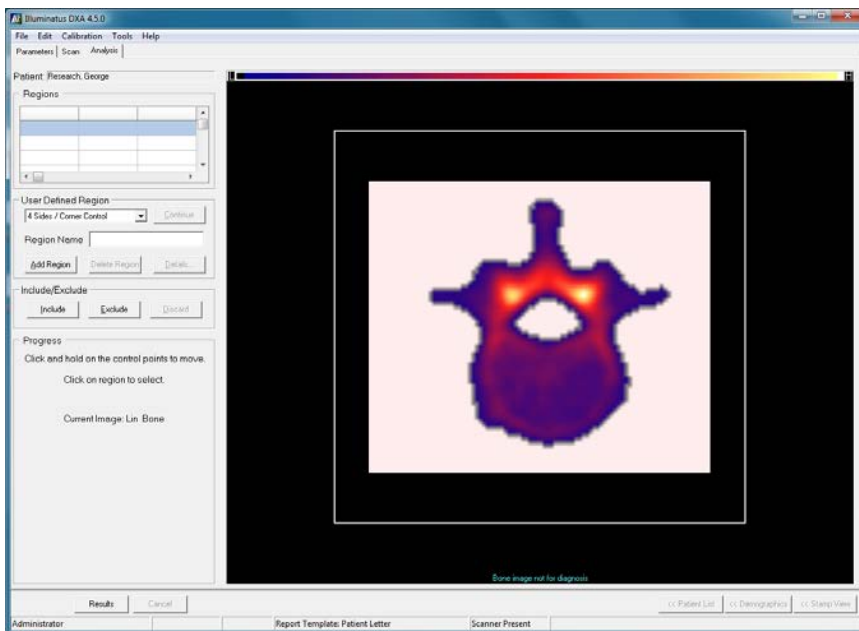

2. In the User Defined Region area of the window, click the drop-down arrow and select a cursor type ("*8 Sides*" is selected here).

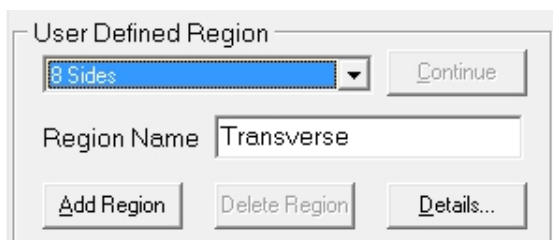

4 Sides / Side Control	Cursor is the original on-axis rectangular area defined with side placement. It is commonly used for regular on-axis areas or areas that need dimensions to be displayed or printed.
4 Sides / Corner Control	Cursor is a quadrilateral area defined with corner placement, resulting in angular special region cursors.
8 Sides / Corner Control	Cursor is an eight-sided area also defined with corner placement. It can be used to circumscribe more complex regions.

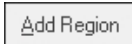
3. Type in a name to identify the special region to be added ("*Transverse*" is used in this example).
4. Click the  button. Notice the addition of an 8-sided Region of interest (ROI) cursor box - with a cursor in each corner of the box.

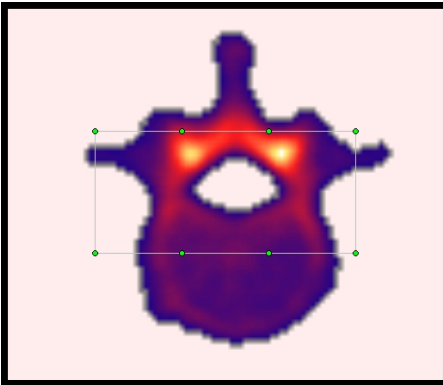

5. Adjust the ROI in accordance with your study protocol. Different protocols have different specifications.
6. In the Regions area of the Analysis tab window, the name of the special region appears under the heading of **Region** (“*Transverse*” and “*Body*” used in the example below). The dimensions of a *4-Sides / Side Control* box are listed under **Length** and **Width**. Corner Control boxes and 8-Sided boxes will not list Length and Width values.

Regions		
Region	Length (cm)	Width (cm)
Body	3.60	5.10
Transverse	*****	*****

7. The Length and Width values will update as control points are adjusted.
8. The cursor can be modified as any other cursor. Click on any point inside the cursor and drag to a new location. Click on any control point to reshape cursor.
9. To add additional regions, return to step 2 above.
10. When all regions have been placed, click (at the bottom of the window).
11. The special regions will be saved with the scan data file. Future scans should use the same dimensions for effective trending comparisons.

Modify an Existing Special Region

1. In the Scan Results window, right-click to open the menu shown below.

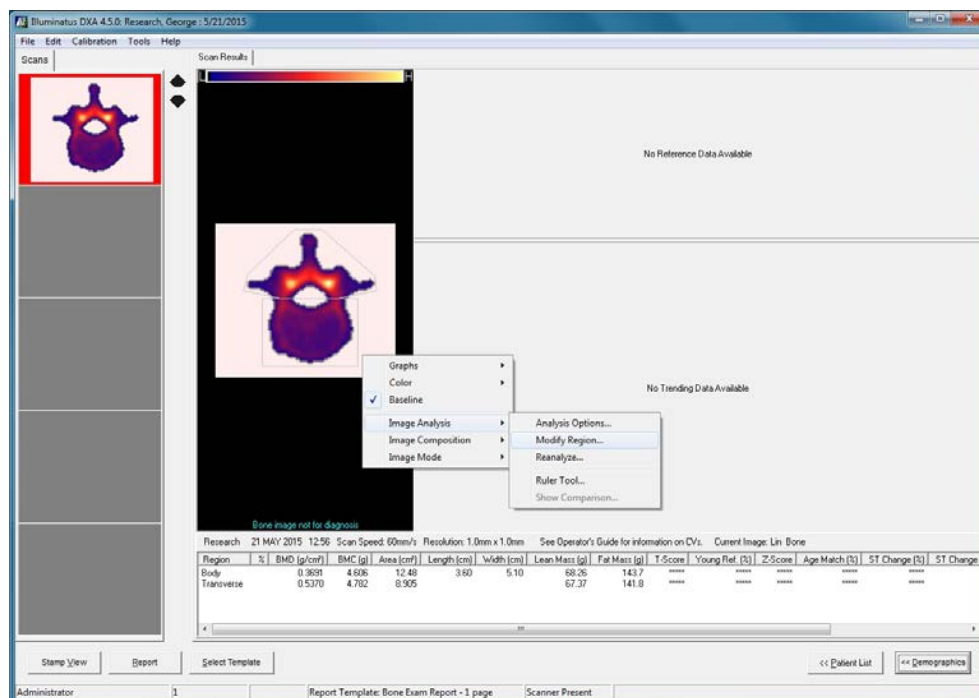

2. Select **Image Analysis > Modify Region**.
3. Click on the border of the region needing to be modified to enable it.
4. Re-position the cursors as needed.

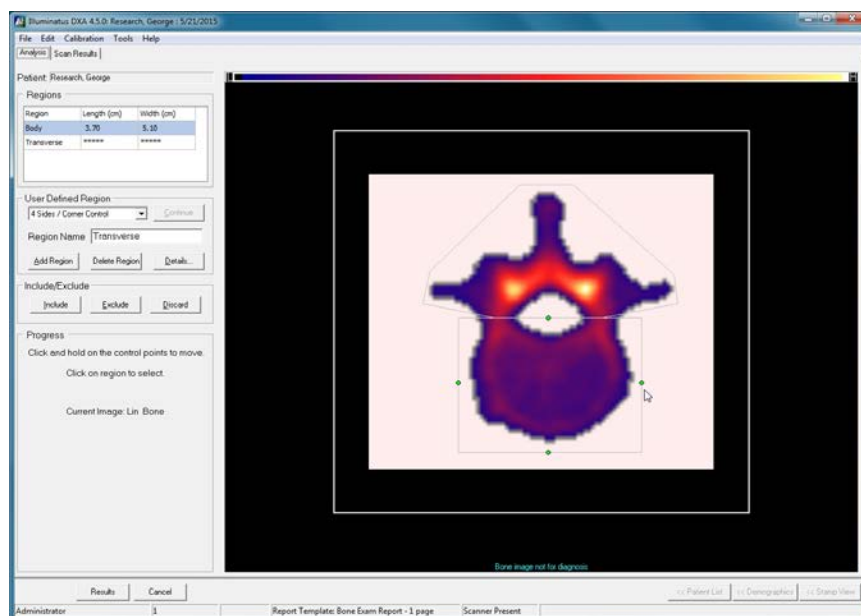

5. Continue positioning the remaining sides or corners of the cursor box until you are satisfied with the cursor box size and placement for the modified region.
6. To modify another region, click on the border of the next region to enable it, and modify the region as needed.
7. Click when finished. Click .

Delete a Special Region

1. In the Scan Results window, right-click to open the menu shown below.

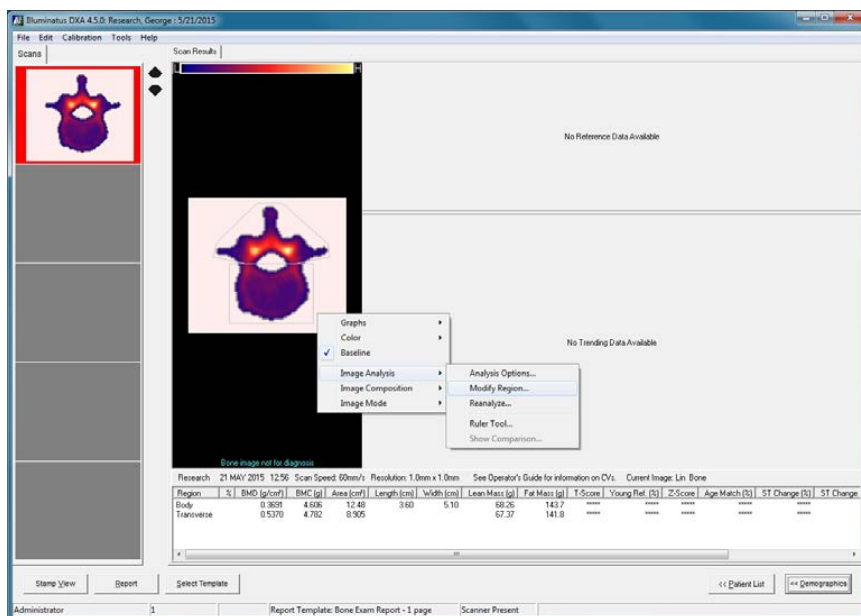

2. Select **Image Analysis > Modify Region**.
3. Click on the border of the region to be deleted.
4. Click **Delete Region**.

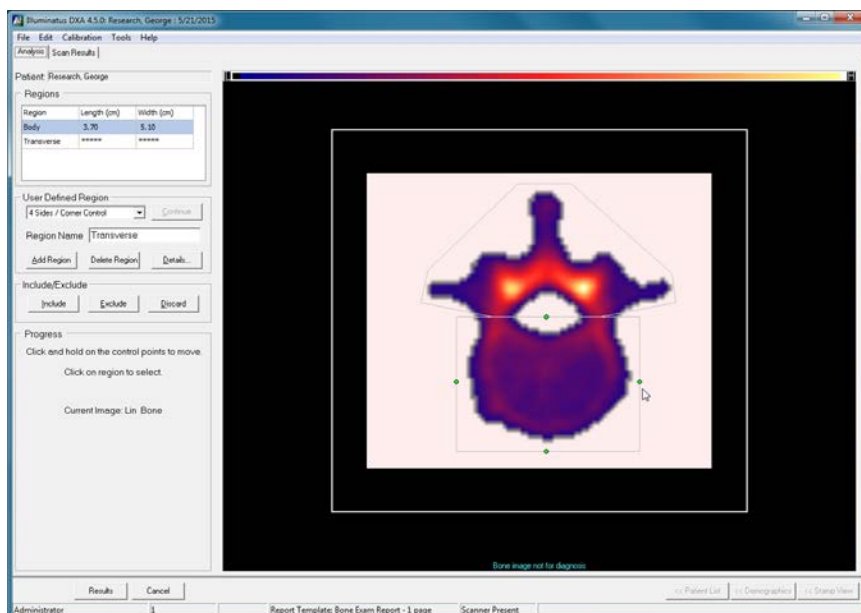

Rename a Special Region

1. In the Scan Results window, right-click to open the menu shown below.

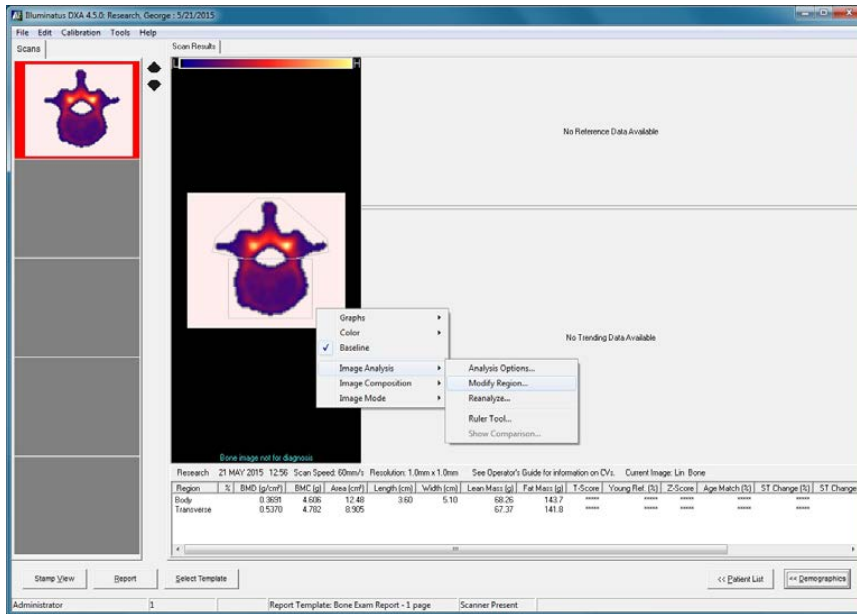

2. Select **Image Analysis > Modify Region**.
3. In the list of regions, highlight the region to be renamed.

Region	Length (cm)	Width (cm)
Body	3.60	5.10
Transverse	*****	*****

4. Click **Details...**

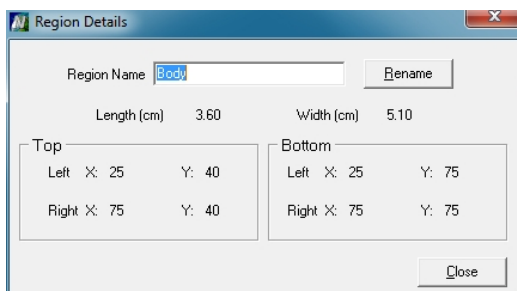

5. In the Region Details window, type a new name for the Region in the Region Name box.
6. Click **Rename**. Click **Close**. The new region name will appear in the Regions table.

Include/Exclude

Although not recommended, it may be necessary to remove artifacts from a scan region (such as hip prosthetics, pins, or staples). Doing so will negate the automatic analysis provided by the Norland software.



Note: The DXA software provides both an *Include* and an *Exclude* function to be used for editing scan results. If it is necessary to use the functions to add or remove artifacts or islands of tissue from a scan region, subsequent scans of the same patient *must* have the identical Include or Exclude operation performed in order to obtain meaningful serial analyses.

Include

The *Include* function allows the operator to include odd-shaped islands of the scan, which did not contribute to BMD results as bone information or were separated from the primary investigation site. It may also be used to recover data points previously excluded (see the "Exclude" on page 11-49 section). Scan data is not changed, but the tabulated result values may be affected by this operation.

1. In the Scan Results tab of the Filmstrip view, right-click to open the menu shown below. Confirm that Baseline is checked.



Note: All non-bone tissue in the Included area will be displayed in the baseline color or shade. (Not related to density spectrum.)

Region	BMD (g/cm ²)	BMC (g)	Area (cm ²)	Length (cm)	Width (cm)	T-Score	Young Ref. (%)	Z-Score	Age Match (%)	ST Change (%)
L3	0.5909	2.342	3.911							
L2 - L3	0.5919	4.516	7.676							

2. Right click again to open the menu and select Image > Modify Region.

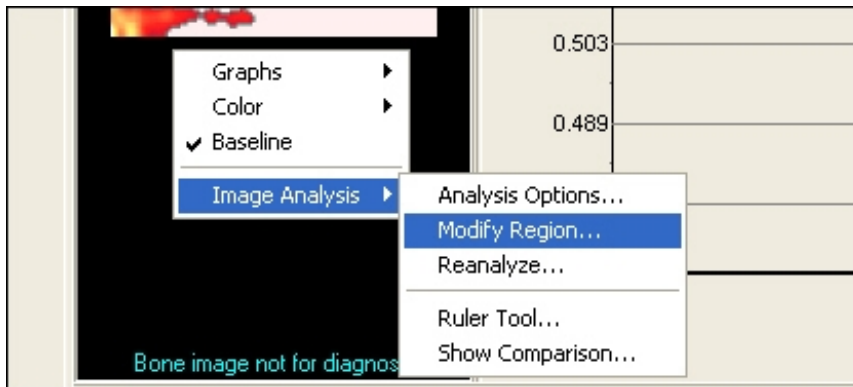

3. Click the button.

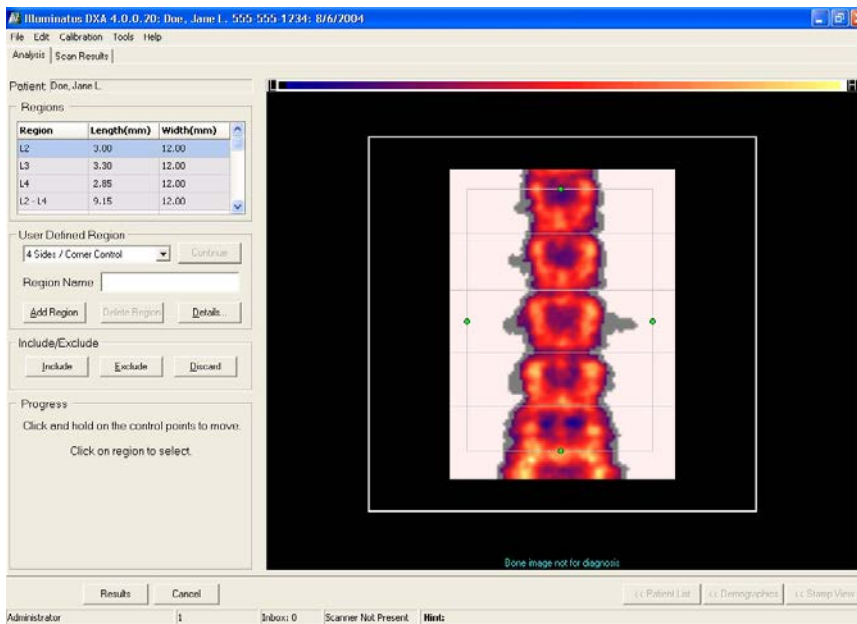

4. Position the pointer on the edge of the include box (left-hand picture) and drag it to the general area to be included. Use the click and drag method to position the cursors around the artifact to be included (middle picture).

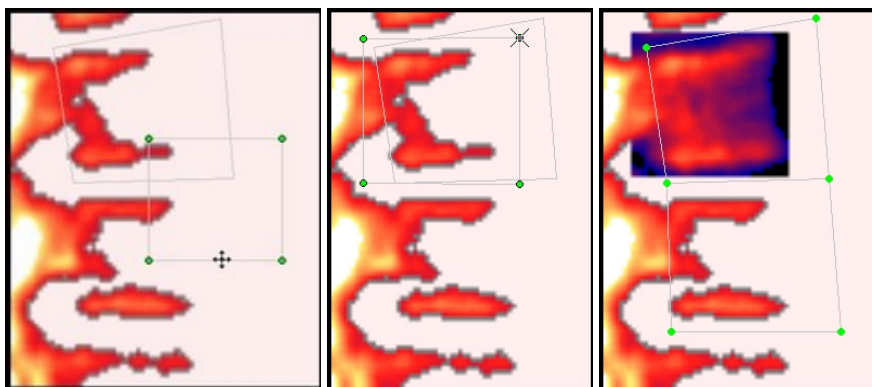

5. When the include box is in position, CLICK ON . The included area is added back into the image (right-hand picture).
6. Repeat steps 3, 4 and 5 to define additional regions to be included.
7. To include an irregularly-shaped artifact, make the size of the include box small. Drag it so it covers a part of the artifact, then click on Continue. Repeat with another small box. Continue this incremental including process until the entire artifact is included.
8. Click the button at the bottom of the window.

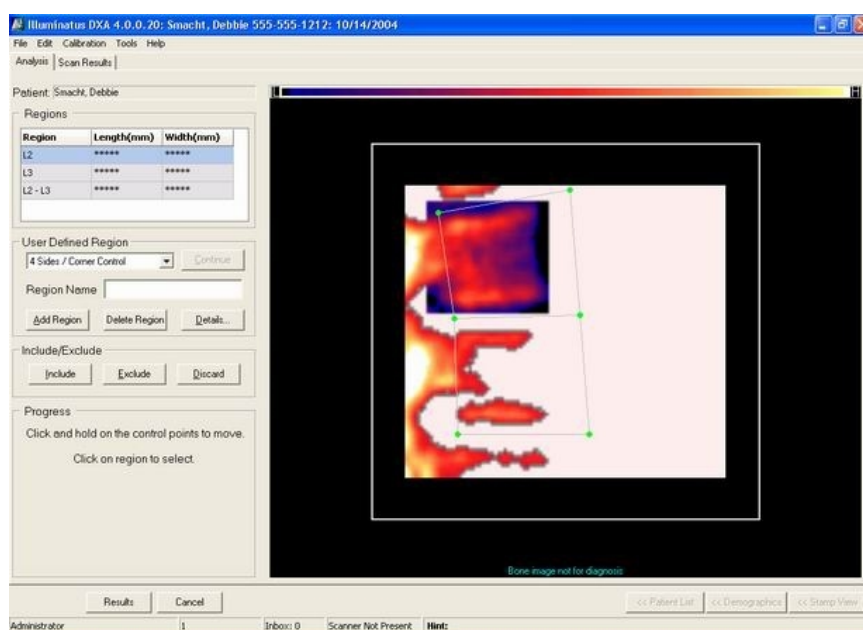

9. Data within the included region is added to the results calculations. Norland software stores the INCLUDE region information with the scan analysis. Click .

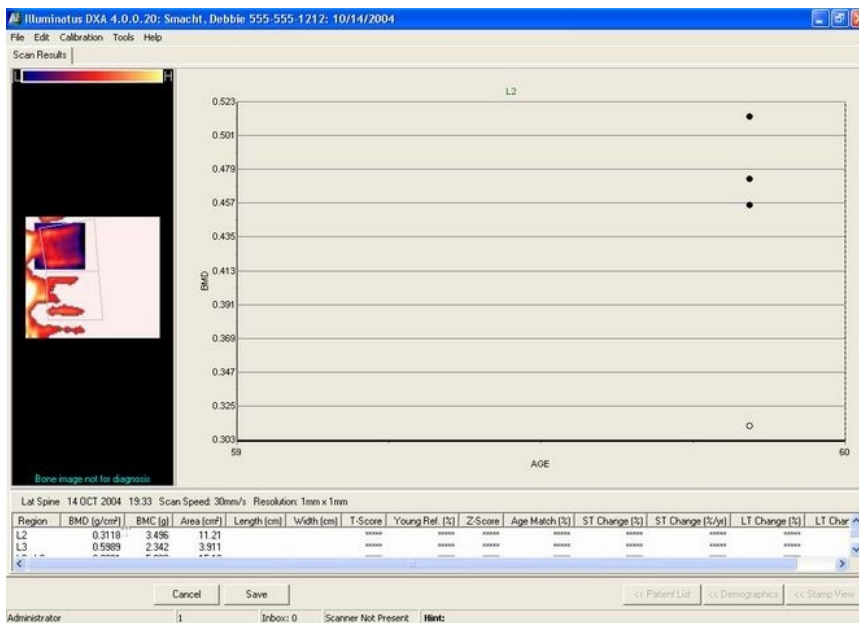

10. The scan is saved and the Filmstrip view appears, showing the newly included region in the thumbnail to the left.

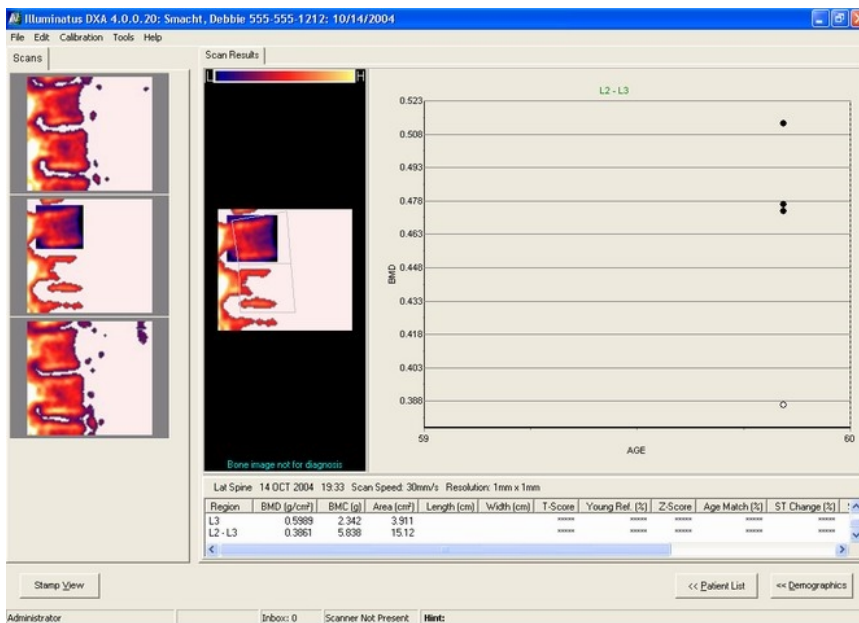

Exclude

The *Exclude* function allows an operator to delete tissue from a scan region. The excluded area is subtracted from the resulting calculations.

Scan data is not changed, but tabulated result values are affected by this operation. The excluded region can be brought back by re-analyzing the scan.

 **Note:** If an external object such as buttons or zippers are included in the scan region, it is better to re-scan the patient after removing the object. Using the Exclude function deletes underlying or superior tissue values in the excluded region from the calculations.

1. In the Scan Results tab of the Filmstrip view, right-click to open the menu shown below. Confirm that Baseline is checked.

 **Note:** All non-bone tissue in the scan image will be displayed in the baseline color or shade. (Not related to density spectrum.)

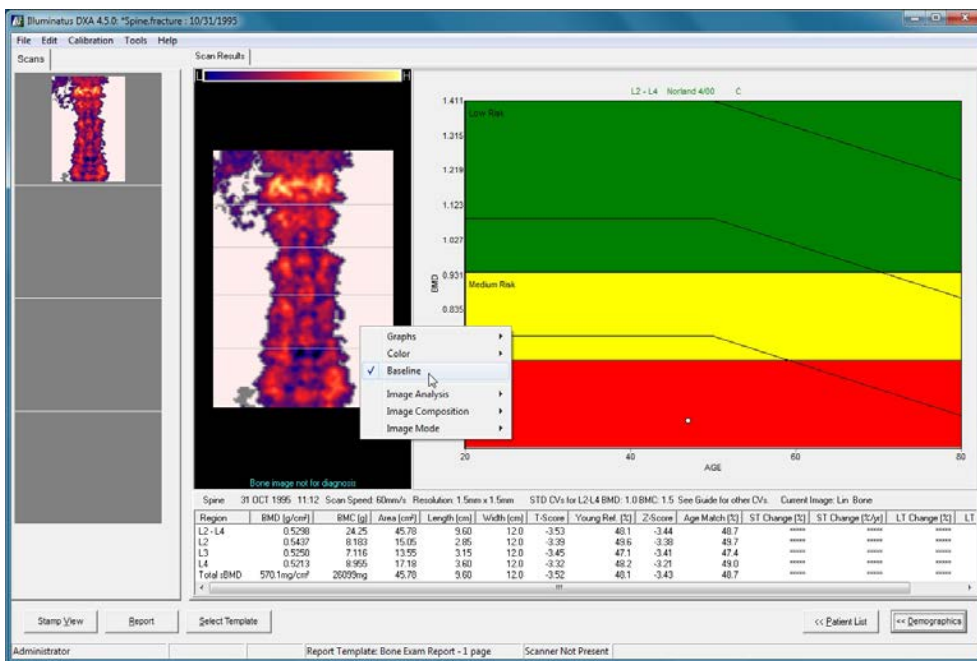

2. Right click again to open the menu and select **Image Analysis > Modify Region**.

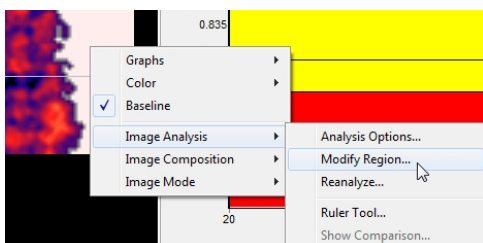

3. Click the **Exclude** button.

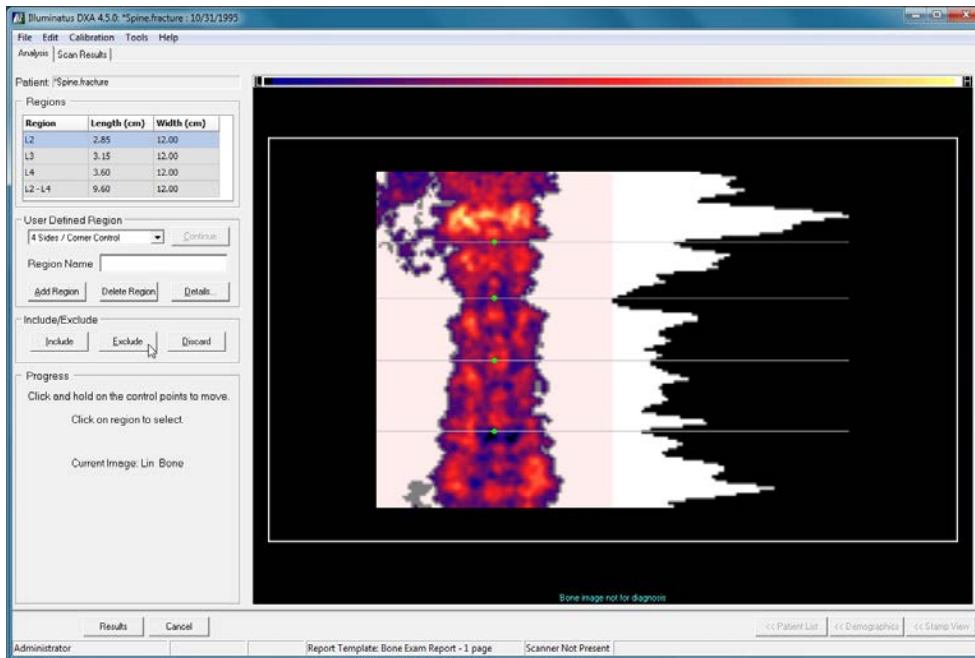

- Position the pointer on the edge of the exclude box (left-hand picture) and drag it to the general area to be excluded. Click and drag to position the cursors around the artifact to be excluded (middle picture).

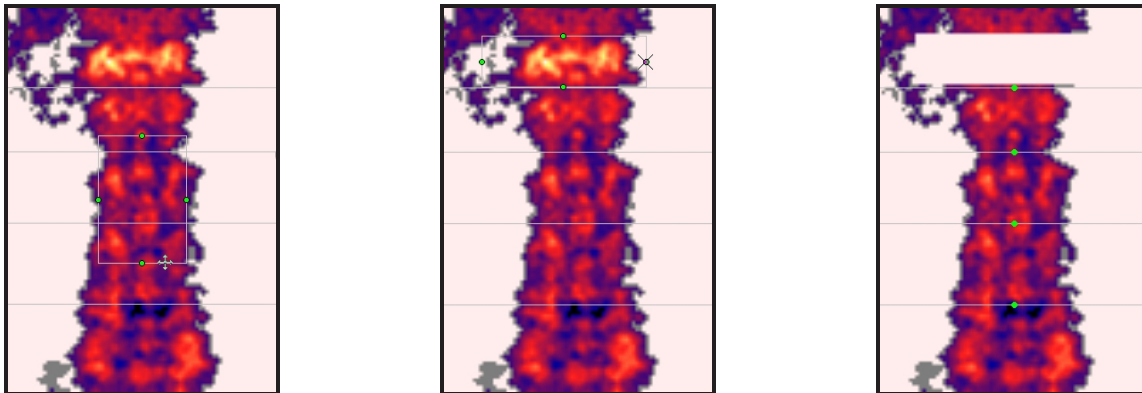

- When the exclude box is in position, click . The excluded area is removed from the image (right-hand picture).
- Repeat steps 3, 4 and 5 to define additional regions to be excluded.
- To exclude an irregularly-shaped artifact, make the size of the exclude box small. Drag it so it covers a part of the artifact, then click on Continue. Repeat with another small box. Continue this incremental excluding process until the entire artifact is eliminated.
- Click the button at the bottom of the window.

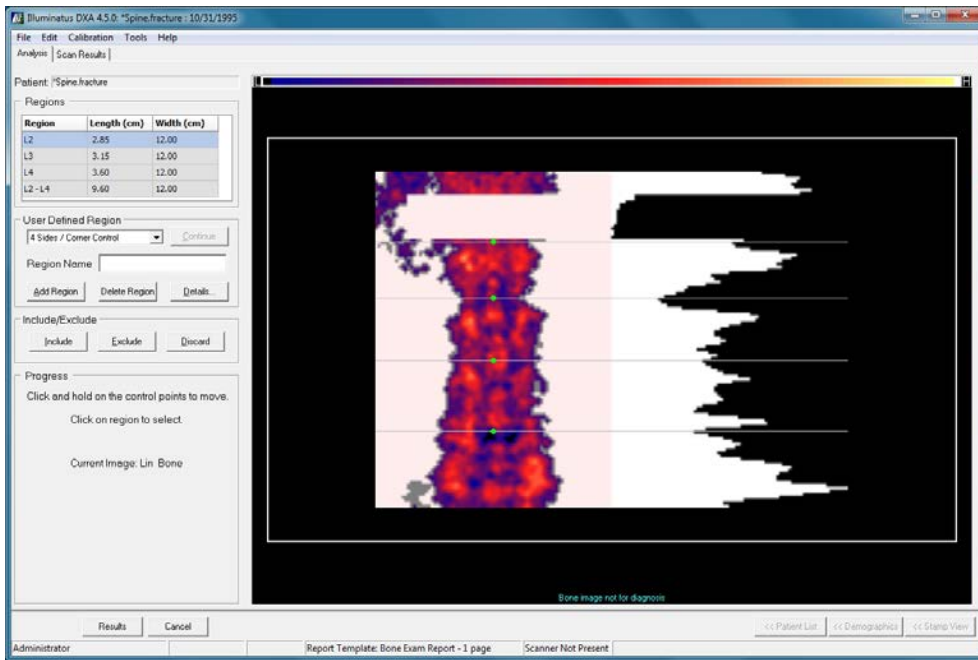

9. Data within the excluded region is removed from the results calculations. The DXA software stores the excluded region information with the scan analysis. Click .

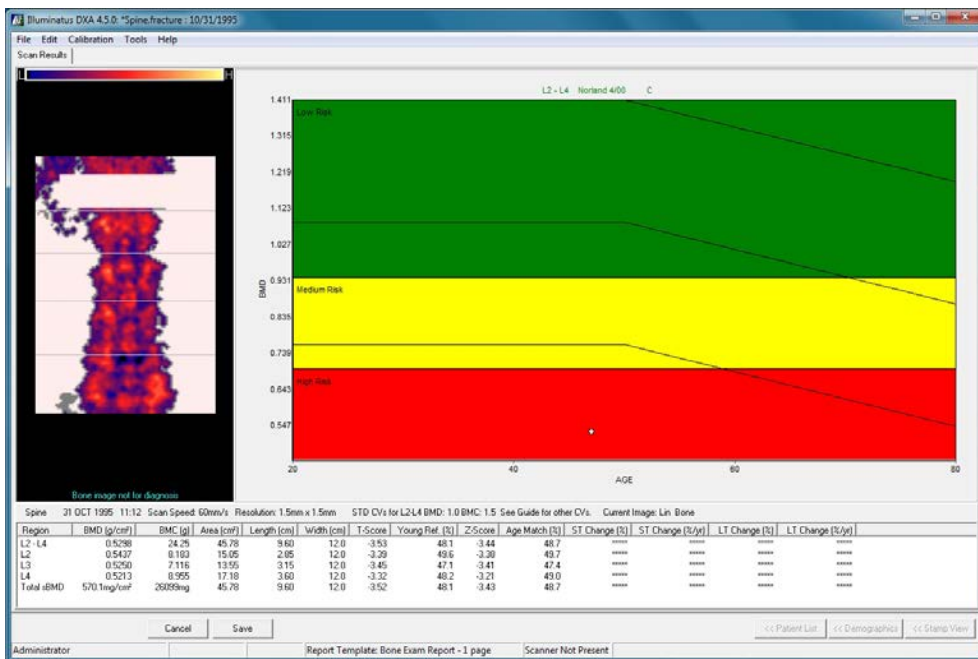

Using the Ruler Tool

A *Ruler Tool* is included in the software for displaying linear measurements of anatomical features.

1. In the Scan Results window, right-click to open the menu shown below. Select **Image Analysis > Ruler Tool**.

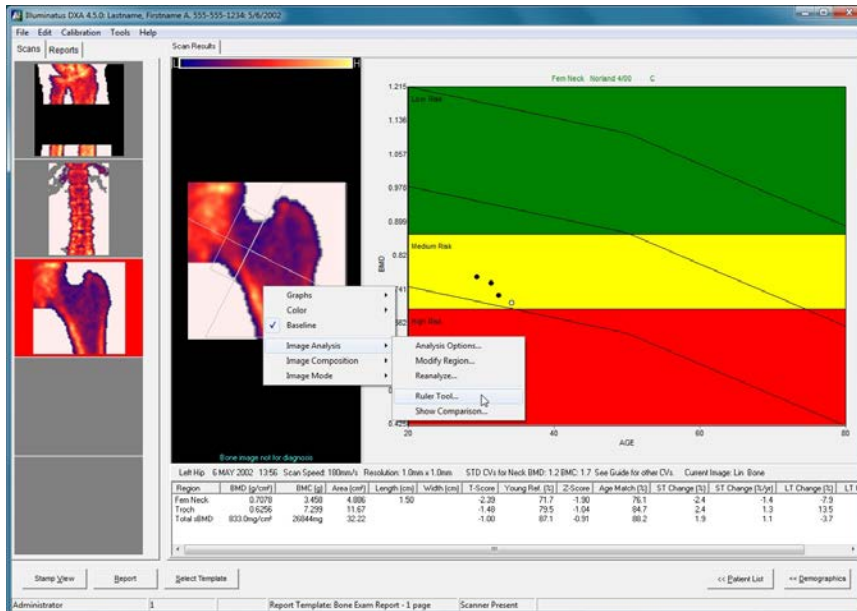

2. The *Ruler Tool* will display on the scan, with cursors at each end.

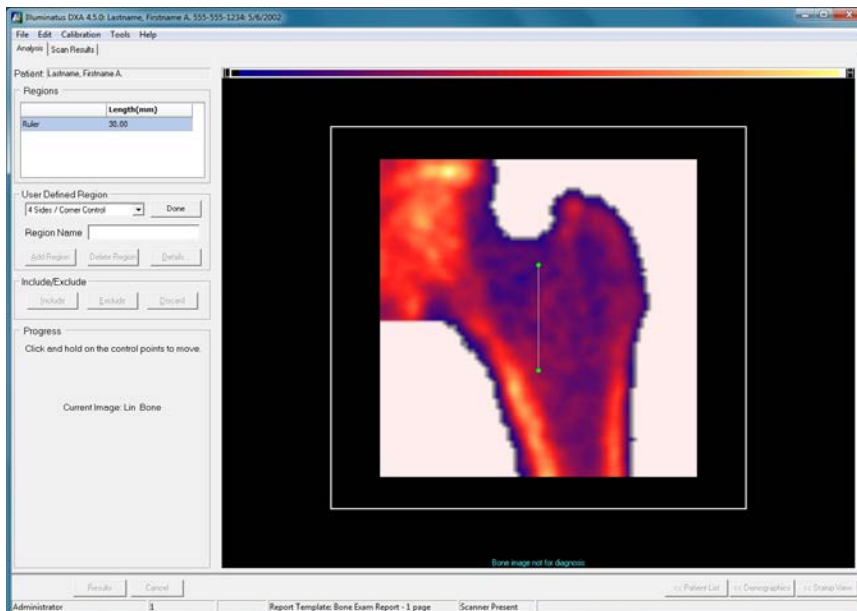

3. Click and drag one end of the ruler to the place being measured.
4. Click and drag the other end of the ruler to the final position and release. The measured length will be displayed in millimeters in the window.

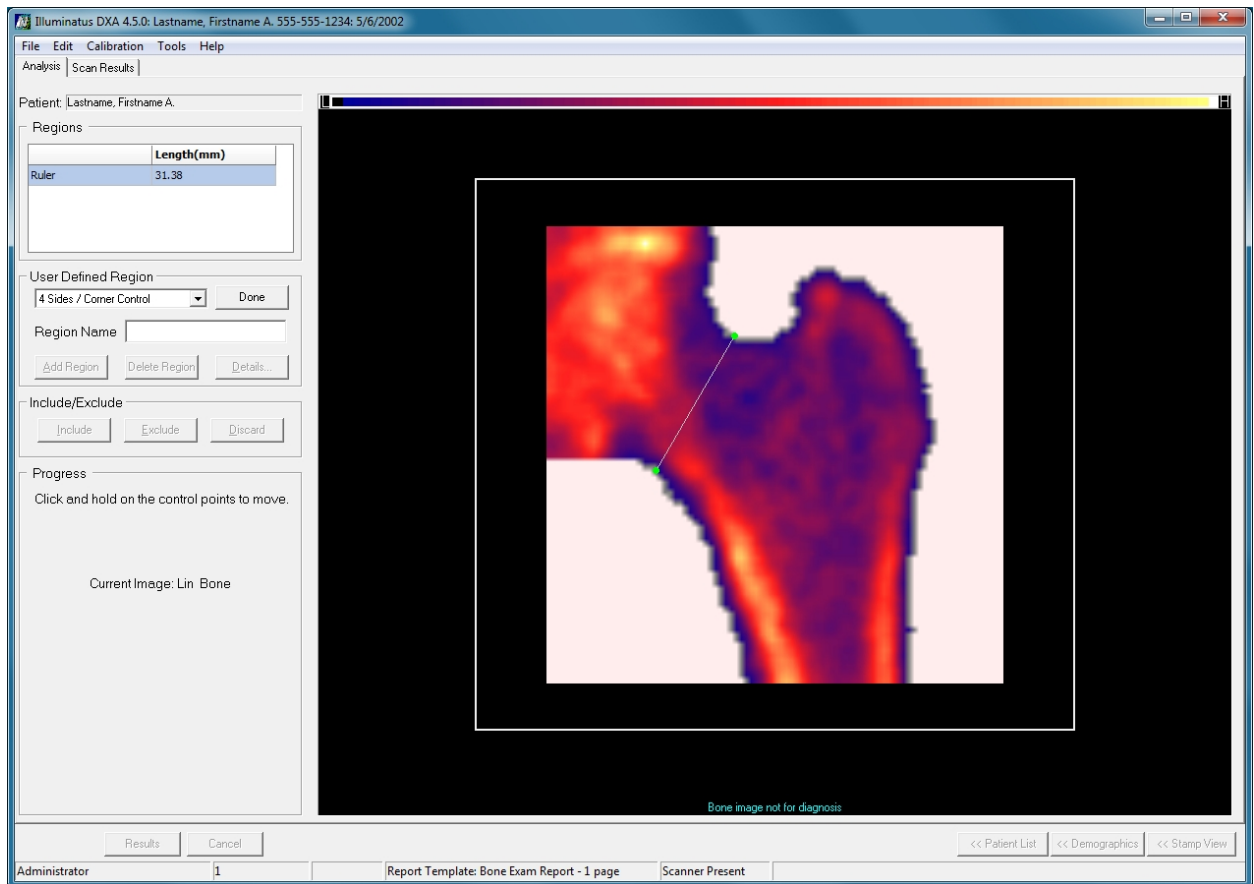

5. Click . The measurement will not be a permanent part of the image.

Comparison Image

To ensure that the region of interest is comparable to previous scans performed on the patient, cursor placement can be modified using the *Comparison Image* function. This is very important for accurate trending results.

1. From the Scan Results window, right click over the scan image to open the menu. Select **Image Analysis > Show Comparison**.

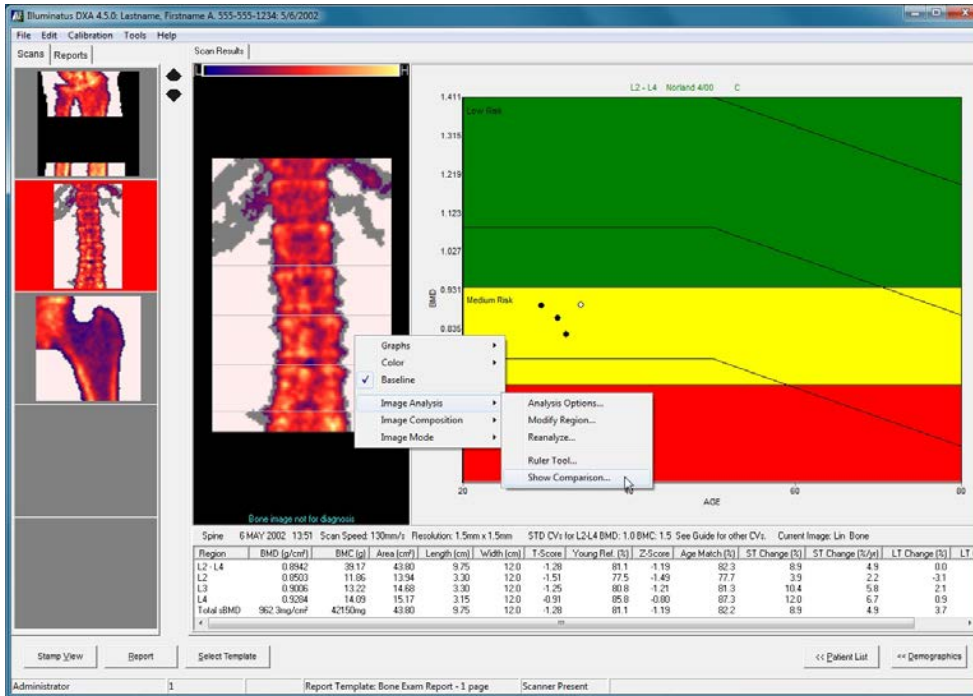

2. The image of the patient's first scan of the same type is recalled and presented to the right of the current scan using the same color scale as the existing image. The example below shows an \overline{AP} Spine Comparison.

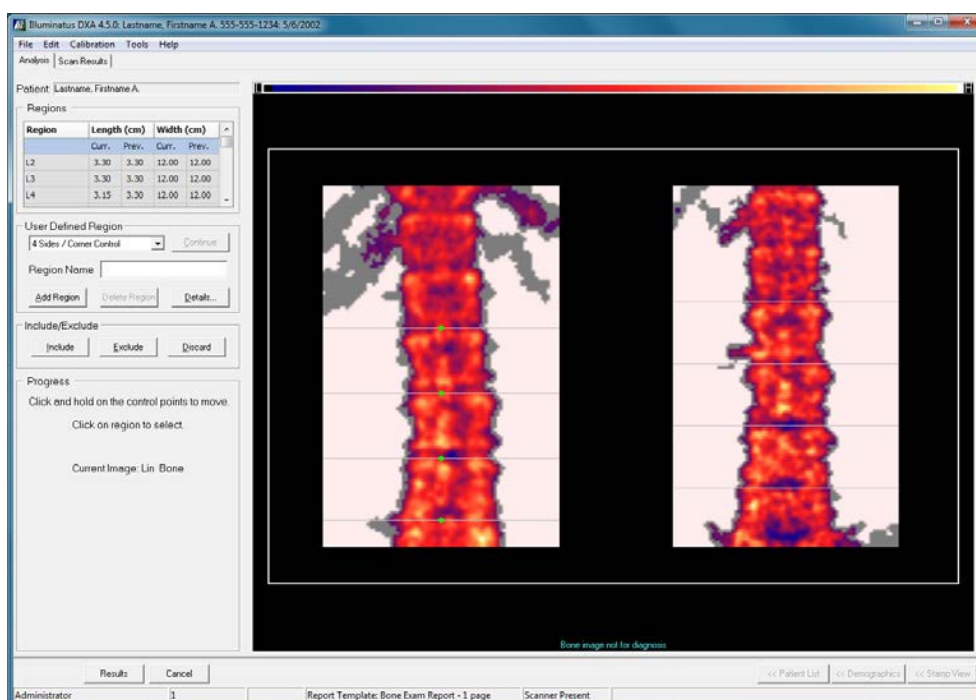

3. Cursors can be positioned to match the comparison image.
4. It will be necessary to rescan if the current scan doesn't match the patient's initial scan.
5. Once positioned, click Results to display the scan results, or right-click and deselect **Image Analysis > Show Comparison** to hide the comparison image and remain in Analysis mode.

Image Composition and Image Mode

The **Image Composition** and **Image Mode** features allow customization of the scan image by selecting an alternate density spectrum distribution algorithm. Quantitative results and scan data remain unchanged, but the image displayed and the printed report can be enhanced in several ways.

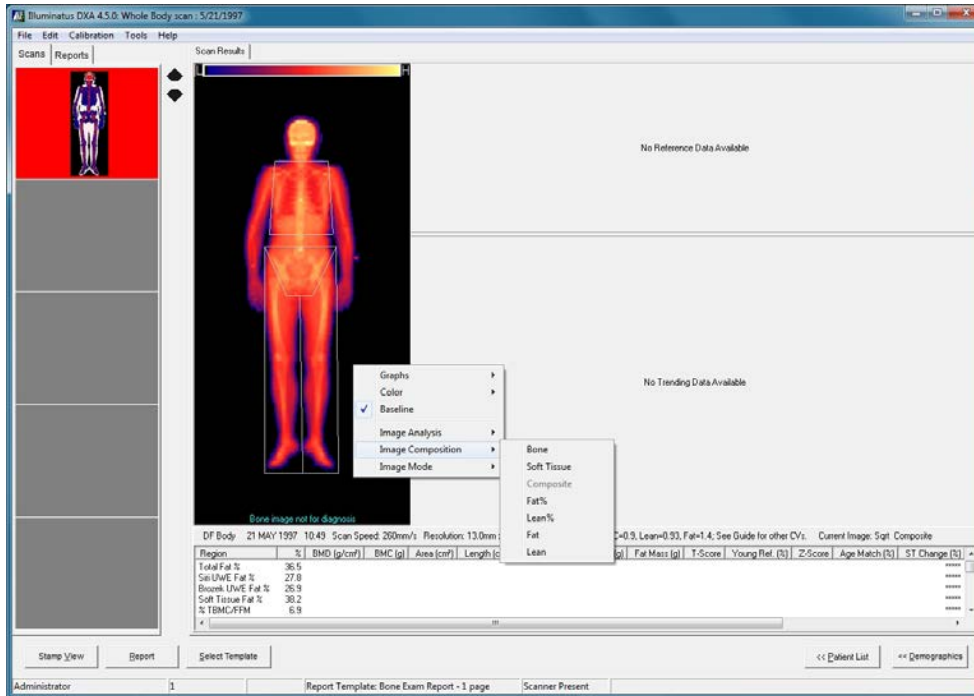

To change the **Image Composition**, right click on the image while in the Scan Results window to open the menu. Select the composition type desired from the **Image Composition** menu.

The following Image Composition types are available:

- » Bone - Default setting for all scan types (except Whole Body) that provides an image of the bone value of each point.
- » Soft Tissue - provides an image scaled in terms of the non-bone tissue value of each point.
- » Composite - Default setting for Whole Body scans that provides a low energy attenuation image similar in appearance to an x-ray film image.
- » Fat % - Provides an image showing regional fat distribution such as pockets of fatty tissue based on a scale of 0-90%, with bone points shown as such.
- » Lean % - Provides an image showing regional lean tissue distribution based on a scale of 0-90%, with bone points shown as such.
- » Fat - Provides an image scaled in terms of the fat value of each point, with the fat at bone points based on the amount of fat found at the last soft tissue/bone borderline location.
- » Lean - Provides an image scaled in terms of the lean tissue value of each point, with the lean tissue at bone points based on the amount of lean tissue found at the last soft tissue/bone borderline location.

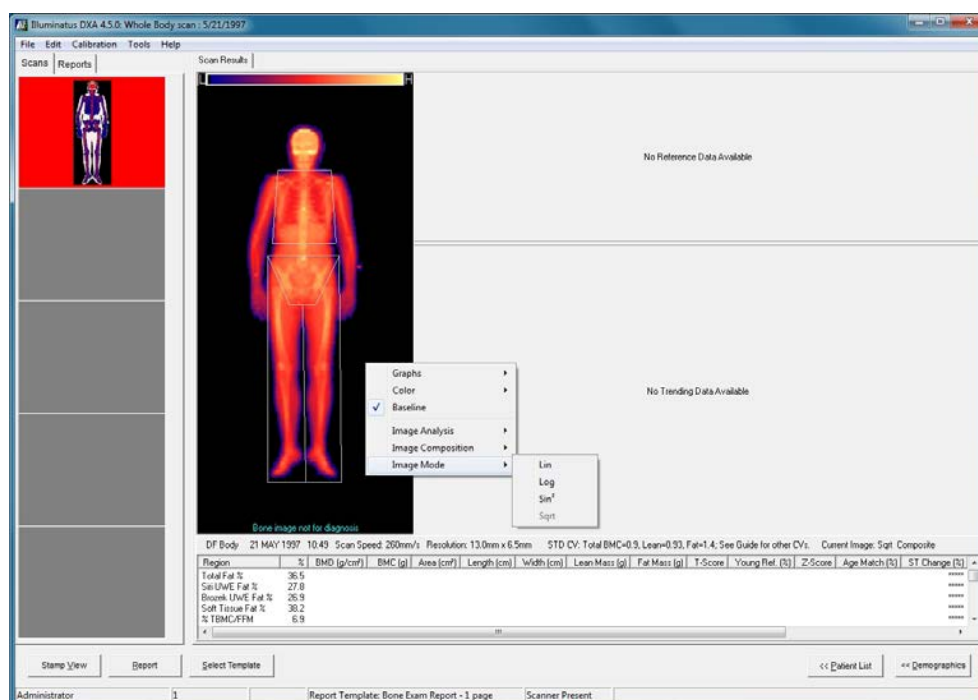

To change the Image Mode, right click on the image while in the Scan Results tab window to open the menu. Select the image type desired from the Image Mode item.

The following Image Mode types are available:

- » Lin - Denotes a linear distribution of data points from minimum to maximum when presenting a scan image. Lin is the default scaling mode when entering analysis and is the most commonly used mode.
- » Log - Denotes a logarithmic scaling of data points. Log accommodates a wide distribution of dynamic ranges of values.
- » Sin² - Denotes a Sin² density scaling. This mode permits the viewer to focus in on specific regions of change such as bone edges.
- » Sqrt - Denotes a square root scaling of the data points and is similar to Log.

The system retains the current Image Mode and Image Composition settings while scans created during the same visit are being viewed. The Image Mode and Image Composition are reset to their default values when the Filmstrip View is exited.

Reports with modified images must be printed before exiting Filmstrip View. Images in saved reports are set to the default setting when the Filmstrip View is exited.

The images in saved reports may be viewed using different Image Modes and Image Compositions. To view a saved report at a later date with a different Image Mode/Image Composition:

1. Select a scan in Stamp View and click Filmstrip View to view the scan in the Scan Results tab window.
2. Select the Image Mode and Image Composition from the popup menu.
3. Click the Reports tab and select the report that is to be viewed.

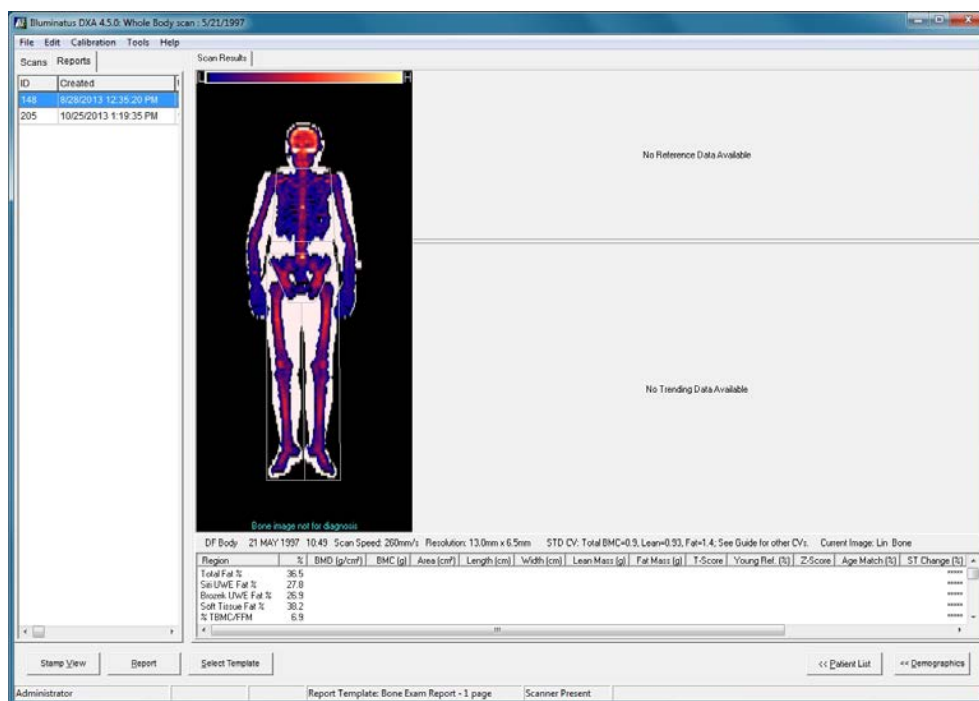

Click **Tools > Report > View Selected** to regenerate the report with the selected image mode.

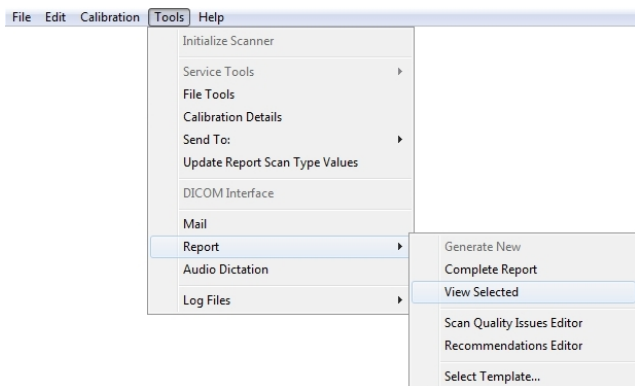

See "Scan Reports" on page 2-12 for more details on viewing reports.

Analyzing Saved Scan Data

The Norland software allows an operator to perform a scan on a patient, save the data, and then analyze the saved scan data later. These procedures explain how to analyze the saved data. The same procedure applies to all of the types of scans.

1. Locate the patient's name (or ID) in the Database Navigator window containing the scan that you want to analyze.
2. For unanalyzed scans, the word "**No**" appears in the column labeled *Analyzed*. If the word "**Yes**" is shown, it indicates that the scan has already been analyzed. If this is the case, you must follow the steps labeled "Reanalyzing Scan Data" on page 11-61 instead.

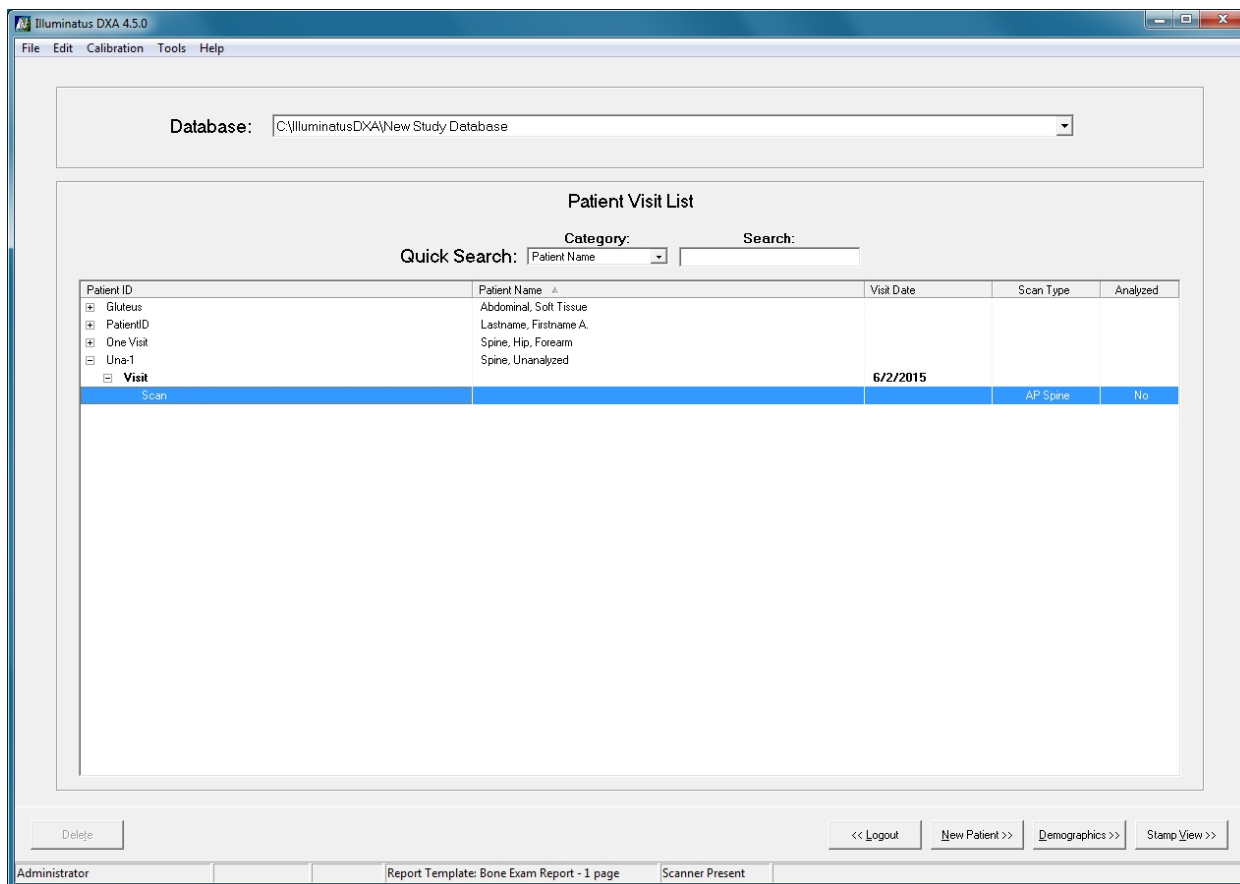

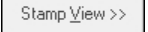
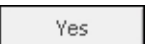
3. Click on .
4. Double click on the stamp view of the scan you want to analyze. The following message will be displayed.
Click  to proceed.

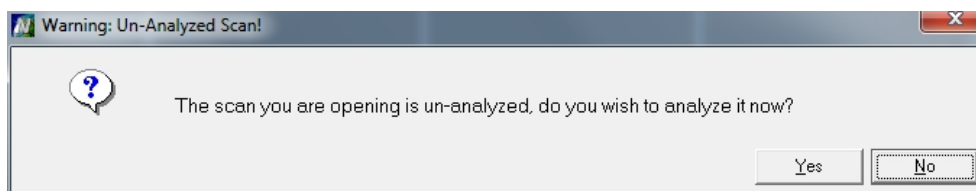

5. The analysis may be performed the same as if the scan had just been acquired. Proceed to the sections listed below to continue the analysis, based on your scan type:
 - » AP Spine scan - see "Analyzing the Scan" on page 7-17
 - » Hip scan - see "Analyzing the Scan" on page 8-23
 - » Lateral Spine scan - see "Analyzing the Scan" on page 10-21
 - » Whole Body scan - see "Analyzing the Scan" on page 5-15
 - » Research and Small Subject - see "Analyzing the Scan" on page 9-16

Reanalyzing Scan Data

Norland software allows an operator to reanalyze a scan using the Reanalyze command. This command starts the Analysis process over from the beginning, retaining any operator-defined special regions.

- » The *Reanalyze* command may also be used to recover all regions which may have been excluded with the *Include/Exclude* function.
- » The *Reanalyze* command is also used to reanalyze old scans with a new version of the Norland software.
- » Reanalyze cannot be used to change the measurement scan region of the patient after the scan data is collected.
- » Scout Scan studies can not be processed by Reanalyze.



Note: If a series of scans are to be Reanalyzed, it is important to reanalyze the patient's *initial* scan first. This will establish new baseline areas and values to which subsequent scans may be compared.

1. From the Scan Results window, right click over the scan image to open the menu. Select **Image Analysis > Reanalyze...**

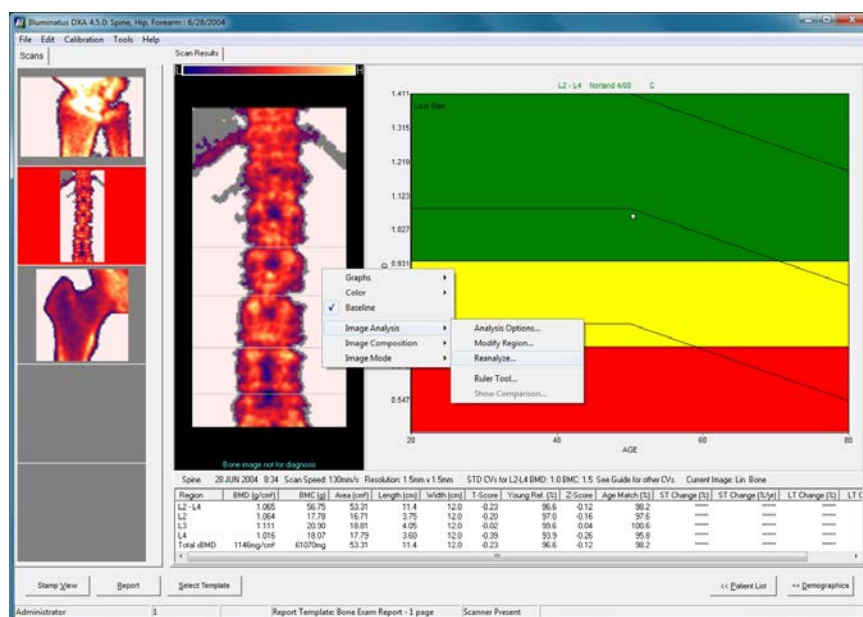

2. The analysis may be performed the same as if the scan had just been acquired. Proceed to the sections listed below to continue the analysis, based on your scan type:
 - » AP Spine scan - see "Analyzing the Scan" on page 7-17
 - » Hip scan - see "Analyzing the Scan" on page 8-23
 - » Lateral Spine scan - see "Analyzing the Scan" on page 10-21
 - » Whole Body scan - see "Analyzing the Scan" on page 5-15
 - » Research and Small Subject - see "Analyzing the Scan" on page 9-16

Changing Height or Weight on the Report

The height and weight on the printed report is saved from the patient's demographic information at the time of the scan. These values do not affect the scan results but can be updated if they were entered incorrectly for a scan.

1. Select a scan on the Stamp View or Filmstrip view.
2. Right-click on the selected scan and select Properties.

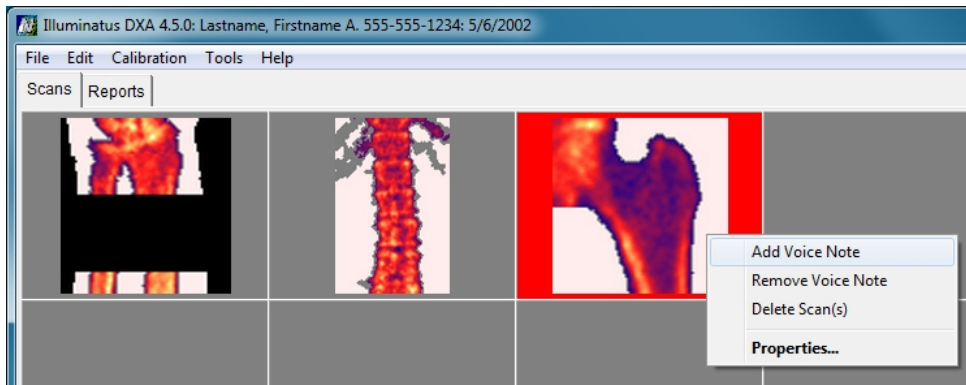

3. Update the Height and/or Weight values in the lower left corner.
4. Click Done when complete.
5. Generate a report and verify the values have been updated.

AP Spine Techniques

Changing the Scan Parameters Prior to Scanning

1. If it is necessary to change the *Speed* or *Resolution*, click on their values and select another value from the drop-down list (see figure below).
2. Click the appropriate check box for *Auto Centering* or *Mark On-Axis* if you must change them.

	Scout Scan	Measure Scan
Speed (mm/sec)	80.0	130.0
Resolution (mm)	1.5 x 0.0	1.5 x 1.5
Width (cm)	14.10	12.00
Length (cm)		0.0
Auto Centering	<input checked="" type="checkbox"/> ON	
Mark On-Axis	<input type="checkbox"/> OFF	

Table 11-2: AP Spine Scan Settings

Setting	Available Settings
Speed (mm/sec)	65, 130*, 260
Resolution (mm)	1.0x1.0, 1.5x1.5*
Auto Centering	On*, Off
Mark On-Axis	On, Off*
* Default settings	

 **Note:** If scan parameter changes are made prior to scanning, they will only apply to the current scan being acquired. To save the changes as defaults for all scans, or to revert to the default values:

Click the  button at the bottom of the Parameters window.

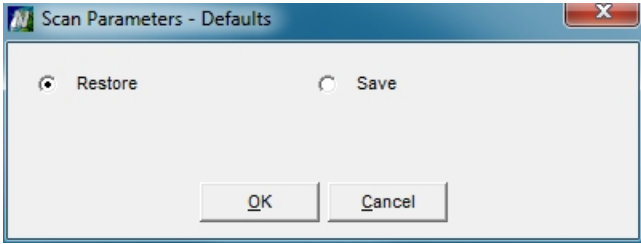

Select *Save* to store these settings as the new default values, or
 Select *Restore* to revert to the previously saved default values.

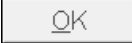
Click  to continue with the scan process.

Unsatisfactory Measure Scan (AP Spine)

If the L1 vertebra or the iliac crests do not appear in the region of interest, there are 3 choices:

1. You may extend the scan by entering a value for the number of lines (1 line = 1.5mm, default 15 lines).

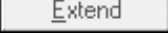
Ensure the arm will not hit the patient with the extended scan length, then click .

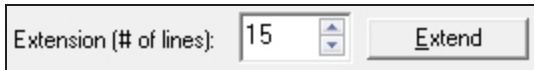

2. OR: you can click and hold on the control points to extend the top of the scan area to include L1. Then click on  to rescan the newly defined scan region.

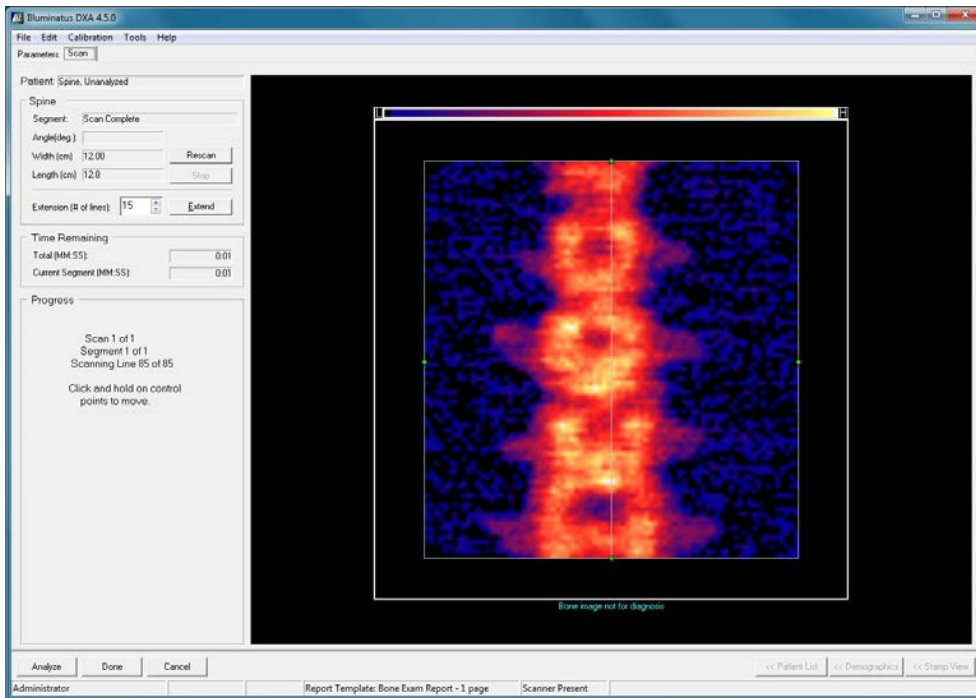

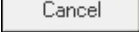
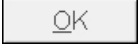
3. OR: if there is not enough room to include L1 when extending the box, click  to remark the patient. In the Cancel Scan dialog box (shown below), select **Discard** and click .

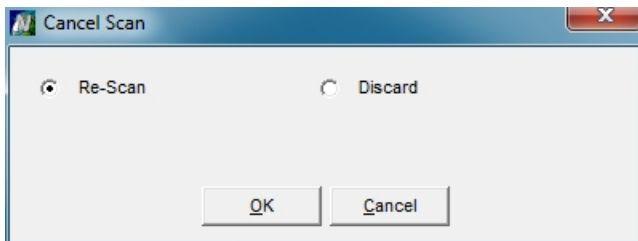

Auto Centering Mode

HOW IT WORKS: The Auto Centering option automatically centers the spine in the image. When Auto Centering is checked (enabled) [default], a 'U' shaped scan is performed prior to the Measure scan (see figure). The start and end points marked by the operator will be on the path of the U.

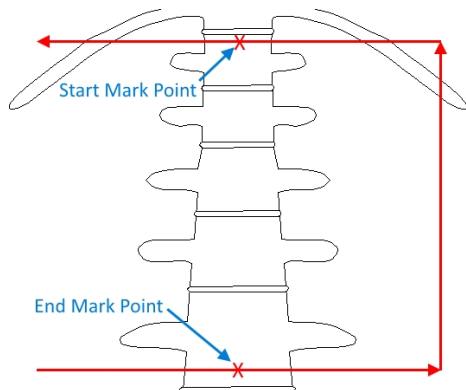

Figure 11-3: Auto-Centering U-Scan



Note: The “Force mark points on-axis” option should be disabled (not checked) to fully take advantage of the Auto Centering mode.

If the start and end points are found to be off center, they are recalculated and implemented for the Measure scan. No operator intervention is required and there is no need to physically reposition the patient.



Note: WHAT TO DO: There are four possible warning dialog boxes that may pop up. They are reprinted next, and discussed.

1. Click on **Continue** to acknowledge any of the warnings.
2. Click on **Stop** to reposition and remark the patient.

- » If automatic centering was not successful, the original start and end points would be used for the *Measure* scan and the following warning message will display:

“The original mark points are being used because the automatic centering of the spine was not successful.”

In this case, Norland recommends that the scan be terminated and the scan region re-marked. Take care to mark 1-cm below the xiphoid and 2-cm below the iliac crests. Note that marking too high or too low caused the Auto Centering to fail.

- » If metal was detected on the U shaped scan, the following warning message will display.
- “The original mark points are being used because metal was detected.”**
- » If auto centering determined that the start and end points would require shifting by 5-cm or more, the following warning will display.
- “The original mark points are being used because the scan was moved 5-cm or more.”**
- » If auto centering determined that the scan would exceed the scanner arm travel limits, the following warning will display.
- “The scan extends off the table. Either remark the scan location or adjust the scan parameters.”**

Force Mark Points On-Axis

When this option is checked (enabled), it forces the densitometer to transverse the scan region in the X & Y axes only. When *not* checked (disabled) [default], it will allow scanning on a diagonal which will automatically straighten the spine in the scan image, despite patient orientation. (It will not straighten scoliotic spines.)



Note: To achieve the highest quality Spine scans, this feature should be DISABLED.

Figure 11-4 illustrates an example of a scan with the Force Mark Points On-Axis checked. Figure 11-5 is the same patient without repositioning and Force Mark Points On-Axis *not* checked.

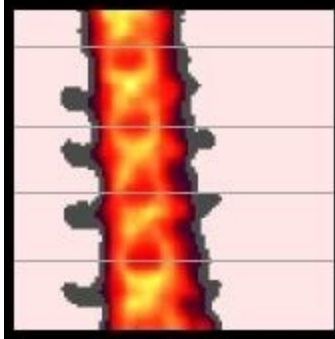

Figure 11-4: Force mark points on-axis checked (enabled)

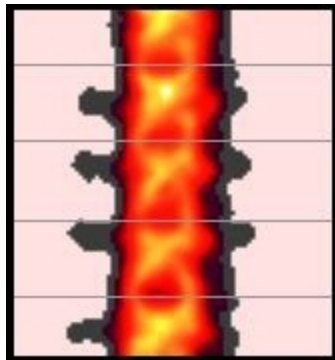
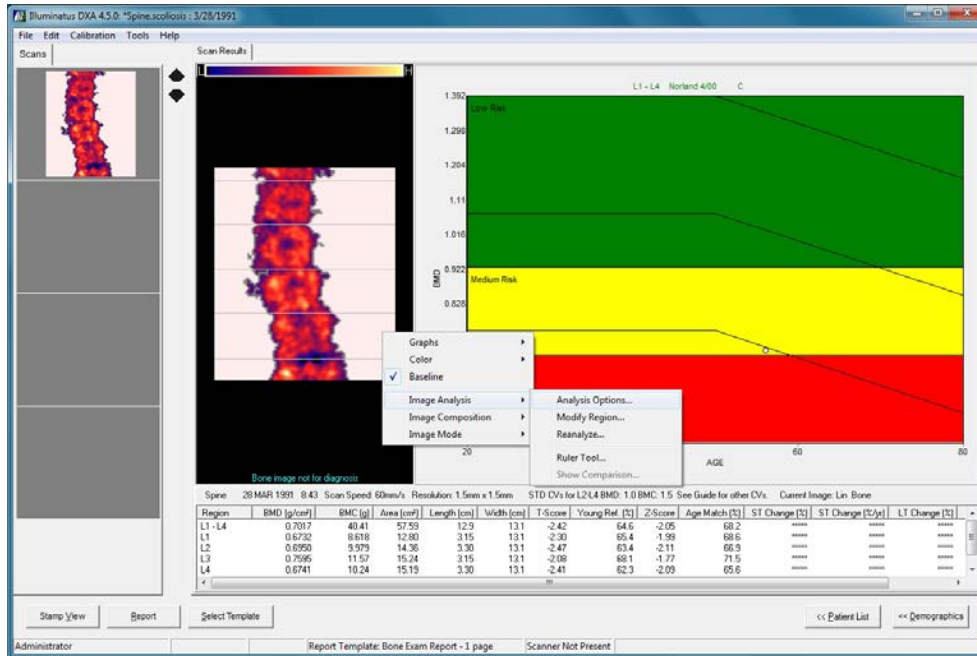

Figure 11-5: Force mark points on-axis not checked (disabled)

Angulated Cursors

The *Angulated Cursors* feature is used during Analysis for a patient who has scoliosis. This feature allows the operator to adjust the angles of the cursors to align with the vertebral gaps.

1. During the Analysis phase of the AP Spine Scan, right click over the scanned image to open the menu. Select **Image Analysis > Analysis Options**.



2. Click on *Angulated* in the Scanner Preferences window to select it. Click .

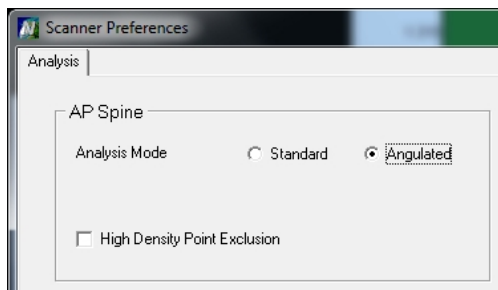

3. The control points on the cursors will now be at the ends instead of the centers. Click and drag the endpoints to align with vertebral gaps of angulated spines.
4. The figure below shows an example of the cursor placement on a scoliotic spine.

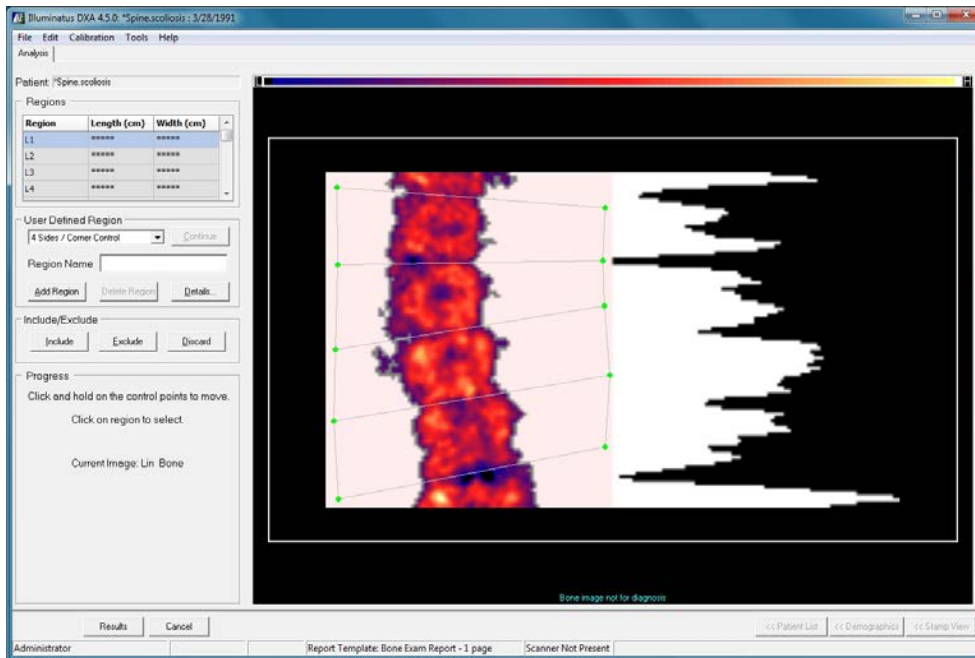

5. Continue with the AP Spine Analysis. See "Viewing the Scan Results Tab" on page 7-21.
6. Regions of interest (L1, L2, L3, L4, L2-L4, L1-L4) will be compared to reference populations which did not include studies with scoliotic spines.

Hip Techniques

Changing the Scan Parameters Prior to Scanning

The Hip Scan *Speed* and *Width* can be changed from the Parameters tab window.

To change the Measure Scan *Speed* parameter, click on the value in the Measure Scan column and select another value from the drop-down list (see figure below).

To change the Scout Scan *Width*, click on the value in the Scout Scan column and select another value from the drop-down list. Note that the Measure Scan width will also change.

	Scout Scan	Measure Scan
Speed (mm/sec)	180.0	90.0
Resolution (mm)	1.0 x 4.0	1.0 x 1.0
Width (cm)	12.00	9.00
Length (cm)	12	9

Table 11-3: Hip Scan Settings

Setting	Available Settings
Speed (mm/sec)	45, 90*
Width (cm)	*Scout 12 cm / Measure 9 cm Scout 16 cm / Measure 12 cm
* Default settings	



Note: If scan parameter changes are made prior to scanning, they will only apply to the current scan being acquired. To save the changes as defaults for all scans, or to revert to the default values:

Click the button at the bottom of the Parameters window.

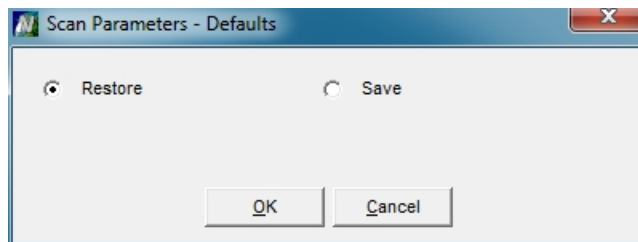

Select *Save* to store these settings as the new default values, or

Select *Restore* to revert to the previously saved default values.

Click to continue with the scan process.

Unsatisfactory Scout Scan (Hip)

If the Hip Scout Scan image is considered *unsatisfactory*, there are 3 options.

Option 1: Extend the Scout Scan

If the entire region of interest (ROI) is not included in the cursor box, the scout scan can be extended to include the ROI.

1. Enter a value for the number of lines (1 line = 4 mm, default 15 lines) in the "Extension (# of lines)".

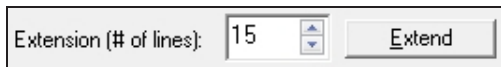

2. Caution the patient to lie still and click .
3. The *Extend* feature may be repeated until the scan length has reached its limit of 255 lines.
4. To set the initial position of the region of interest (ROI), click and drag the target cursor to the middle of the femoral neck.
5. Proceed with "Starting the Measure Scan" on page 8-21.



Option 2: Reposition the Scout Box and Rescan

Use the *Rescan* feature to re-define the region of interest (without re-marking the patient) and run a new Scout Scan.

1. Click and drag the target cursor to the middle of the femoral neck. If the femoral neck is not visible, you may reposition the scout box at any location closer to the neck region.
2. Caution the patient to lie still. Click on .
3. The scanner will perform a new Scout scan in the newly defined region of interest.
4. Proceed with "Starting the Measure Scan" on page 8-21.

Option 3: Cancel the Scout Scan and Remark

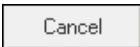
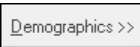
Cancel the scan and restart the procedure if the hip is too wide to fit in the cursor box. In this case, you must increase the Scan Width parameter to include the entire Trochanter and Ischium.

1. From the Scan tab window, click on .
2. At the Cancel Scan window, select Discard and click OK.
3. To restart the scan process, click , then click . Select Left Hip or Right Hip and click OK.
4. In the Parameters tab window, click on the 12 in the Width box (of the Scout Scan column). Select 16 to increase the width of the Scout Scan. This will resize the ROI.

	Scout Scan	Measure Scan
Speed (mm/sec)	180.0	90.0
Resolution (mm)	1.0 x 4.0	1.0 x 1.0
Width (cm)	12.0	9.00
Length (cm)	12.0 16.0	9

5. Proceed to "Marking the Scan Region" on page 8-16 to continue.

Alternate R-Value Analysis



Note: Norland strongly recommends viewing hip scan in the baseline mode.

Baseline displays non-bone data points in the image in the baseline color or shade. If the image appears to have missing areas of bone then the “Alternate R-Value” option should be disabled and the scan reanalyzed. Changing the Alternate R-Value option can make a large difference in the T-Score and Z-score.

View in the Baseline Mode

1. Right click on the scan image in the Filmstrip view to access the image menu.

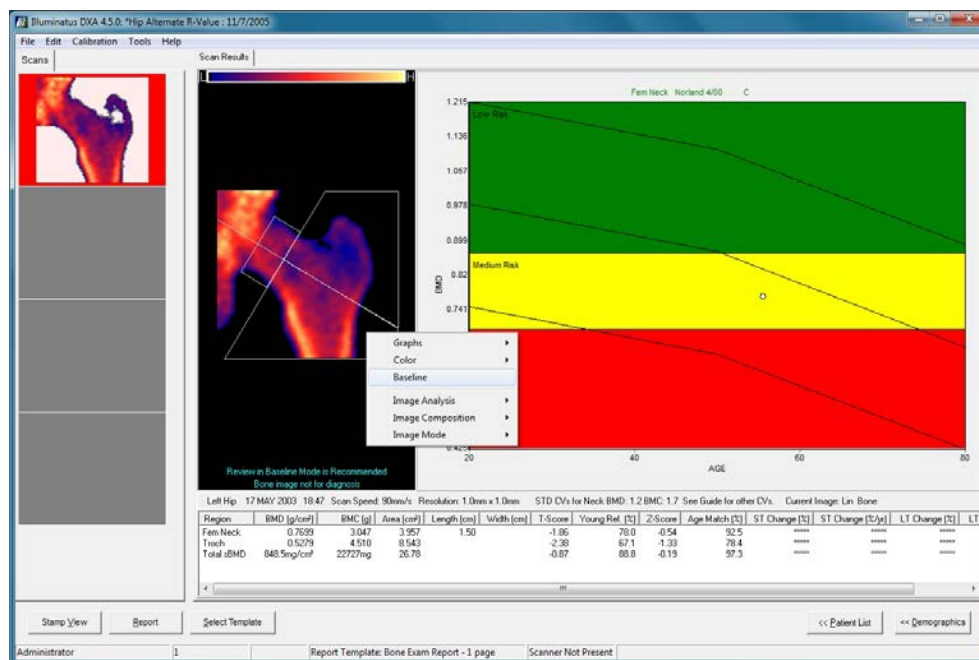

2. Click on Baseline. The image will display all the non bone data points.

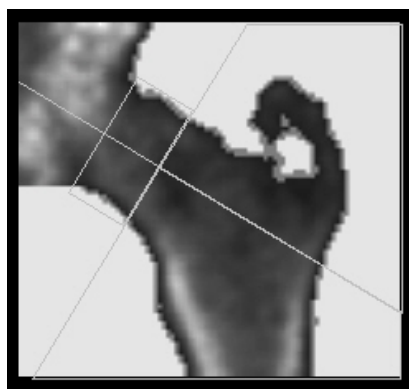

Image with Baseline enabled

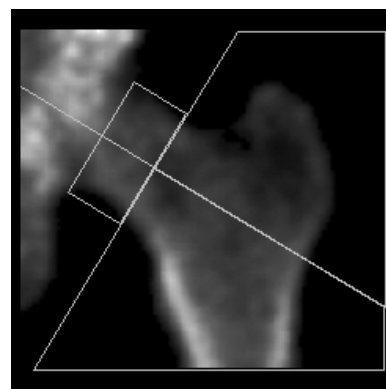
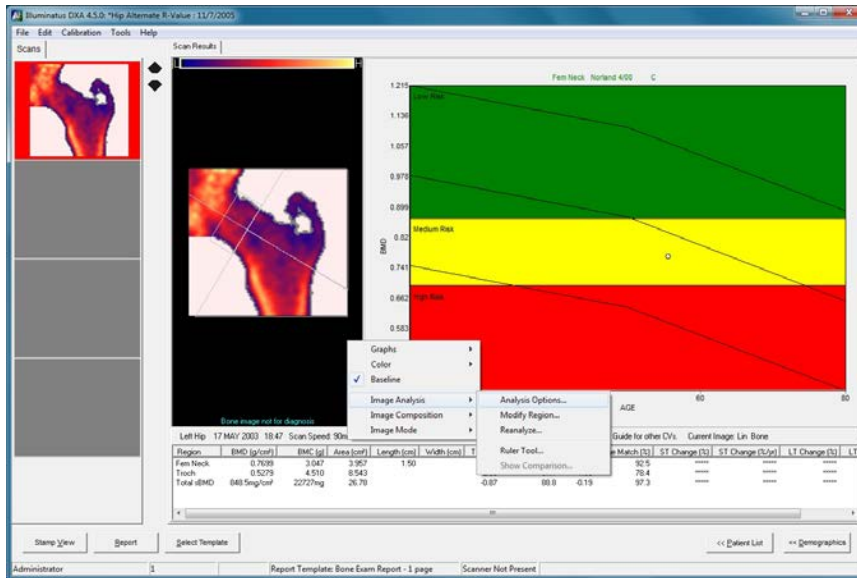

Image with Baseline disabled

Reanalyze with Alternate R Value

1. Right click on the scan image in the filmstrip view. Click **Image Analysis > Analysis Options**.



2. Uncheck the box for Alternate R-Value Analysis. Click on .

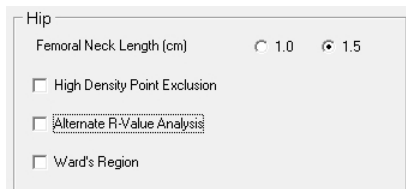

3. When the Analysis tab window opens, place the target cursor in the middle of the femoral neck.

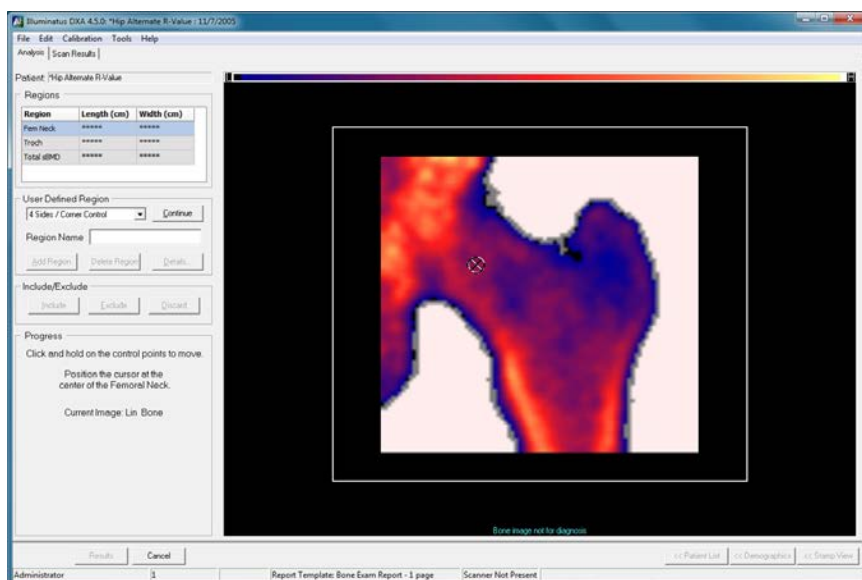

4. Click . If the automatic computer analysis is successful, the software will construct a cursor box and the *Results* button will become available.

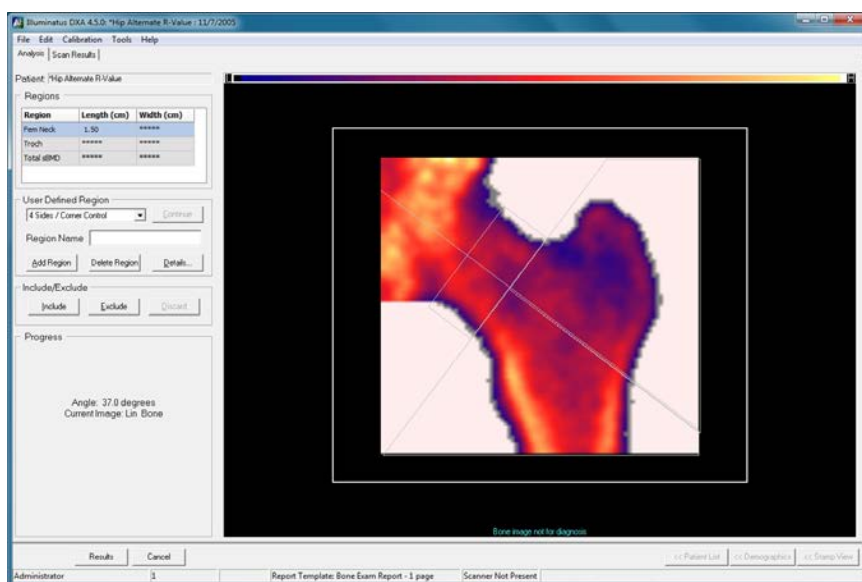

5. Click .
6. The proper analysis will include all areas of bone and have proper cursor placement. Click to save the Scan Results.

Forearm Analysis Techniques



Conversion of Comac Forearm Scans

In previous versions of Norland software, forearm analysis could be done using two different modes: Comac and Hydroxyapatite. Comac analysis has been discontinued; however, Comac-analyzed forearm scans may be converted to Hydroxyapatite analysis.

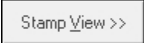
To Convert a Scan:

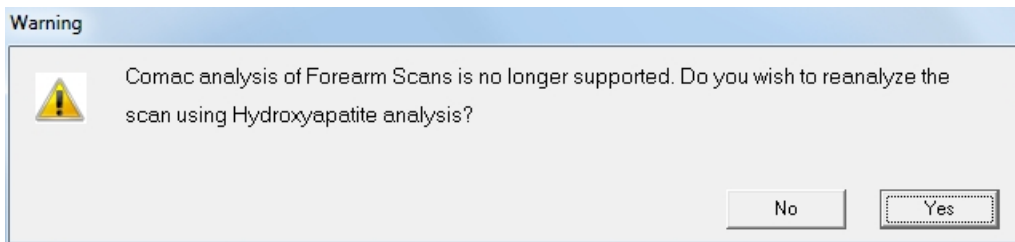
1. Locate the patient's name in the Database Navigator and select the visit which contains the Comac-analyzed scans.
2. Click .
3. Double click on the Comac-analyzed scan to display the scan.
4. A message box will appear stating Comac analysis is no longer supported.

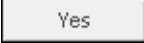

1. Click  to reanalyze the scan using Hydroxyapatite.
2. After the scan is reanalyzed, click  to view the scan results.
3. Click  to save the Hydroxyapatite analysis.

Whole Body Scanning Techniques

Changing the Scan Parameters Prior to Scanning

If it is necessary to change the Scan *Speed/Resolution*, click on its value and select another value from the drop-down list (see figure below).

Measure Scan	
Speed/Resolution	6.5 X 13.0 @ 260 ▾
	6.5 X 13.0 @ 260
Length (cm)	6.5 X 13.0 @ 130
	4.5 X 9.0 @ 260
	4.5 X 9.0 @ 130
	2.8 X 7.8 @ 200
	2.8 X 7.8 @ 100

Table 11-4: Whole Body Scan Settings

Setting	Available Settings
Speed/Resolution	* 6.5 mm x 13.0 mm @ 260 mm/s 6.5 mm x 13.0 mm @ 130 mm/s 4.5 mm x 9.0 mm @ 260 mm/s 4.5 mm x 9.0 mm @ 130 mm/s 2.8 mm x 7.8 mm @ 200 mm/s 2.8 mm x 7.8 mm @ 100 mm/s
* Default setting	



Note: If scan parameter changes are made prior to scanning, they will only apply to the current scan being acquired. To save the changes as defaults for all scans, or to revert to the default values:

Click the **Defaults** button at the bottom of the Parameters window.

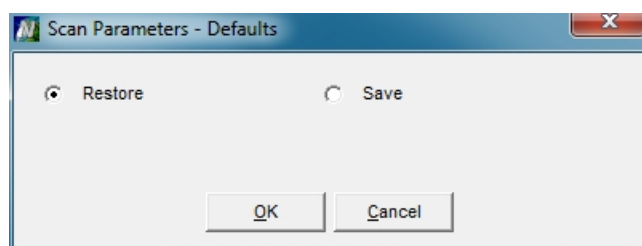

Select *Save* to store these settings as the new default values, or

Select *Restore* to revert to the previously saved default values.

Click **OK** to continue with the scan process.

Lateral Spine Scanning Techniques

Changing the Scan Parameters Prior to Scanning

1. If it is necessary to change the Measure Scan *Speed*, click on its value and select another value from the drop-down list (see figure below).
2. Click the check box for *Measure Scan On-Axis* if you must change it.

	Scout Scan	Measure Scan
Speed (mm/sec)	130.0	30.0
Resolution (mm)	1.5 x 3.0	1.0 x 1.0
Width (cm)	14.25	10.00
Length (cm)	0.0	0.0
Measure on Axis	<input checked="" type="checkbox"/> ON	

Table 11-5: Lateral Spine Scan Settings

Setting	Available Settings
Measure Speed (mm/sec)	15, 30*, 60
Width (cm)	Scout: 14.25*, User-Defined Measure: 10.0*, User-Defined
Measure on Axis	On*, Off
* Default settings	

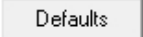

Note: If scan parameter changes are made prior to scanning, they will only apply to the current scan being acquired. To save the changes as defaults for all scans, or to revert to the default values:

Click the  button at the bottom of the Parameters window.

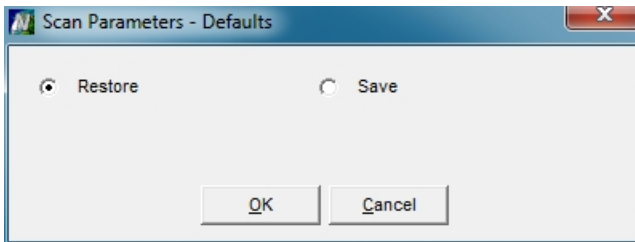



Select *Save* to store these settings as the new default values, or

Select *Restore* to revert to the previously saved default values.

Click  to continue with the scan process.

Unsatisfactory Scout Scan (Lateral Spine)

UNSATISFACTORY: If the lumbar segment is not straight, the Scout image quality is unsatisfactory. You must discard the scan, re-mark the Scan Region and re-start the Scout Scan process. Before beginning the Scout scan, you must first disable the Measurement on Axis feature (set to OFF).

1. From the Scan tab window, click on .
2. At the Cancel Scan window, select Discard and click OK.
3. To restart the scan process, click , then click . Select Lateral Spine and click OK.
4. In the Parameters tab window, uncheck the box for *Measure on Axis* to turn the setting OFF. This will allow the Measure Scan to be scanned on an angle.

	Scout Scan	Measure Scan
Speed (mm/sec)	130.0	30.0
Resolution (mm)	1.5 x 3.0	1.0 x 1.0
Width (cm)	14.25	10.00
Length (cm)	0.0	0.0
Measure on Axis	<input checked="" type="checkbox"/> ON	

5. Proceed to "Marking the Scan Region" on page 10-13.

Research and Small Subject Techniques

Changing the Scan Parameters Prior to Scanning

If it is necessary to change any of the parameters, click on their values and select another value from the drop-down list (see figure below). Adjust the parameters as required for your study protocol.

	Scout Scan	Measure Scan
Speed (mm/sec)	60.0	60.0
Resolution (mm)	3.0 x 3.0	1.0 x 1.0
Width (cm)	13.80	10.00
Length (cm)	0.0	0.0
Force On-Axis		<input checked="" type="checkbox"/> ON
Max Degrees		15
Scout Scan	<input checked="" type="checkbox"/> ON	
Scan Type Name		Research

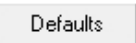

Note: If scan parameter changes are made prior to scanning, they will only apply to the current scan being acquired. To save the changes as defaults for all scans, or to revert to the default values:

Click the  button at the bottom of the Parameters window.

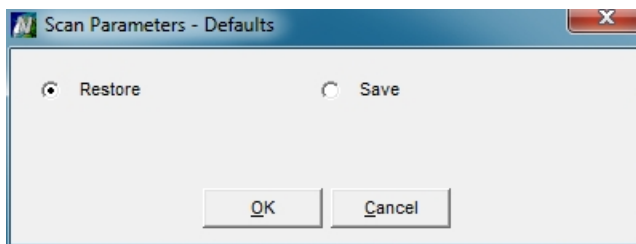

Select *Save* to store these settings as the new default values, or

Select *Restore* to revert to the previously saved default values.

Click  to continue with the scan process.

CHAPTER 12

Ten Year Fracture Risk



Note: The Ten Year Fracture Risk feature is available as an option with the Bone Densitometer. Be aware that your system might not have this option.

A Ten Year Fracture Risk assessment may be provided for patients by entering demographics information, performing a hip scan, and creating a Ten Year Fracture Risk report.

The Ten Year Fracture Risk feature is intended to aid the clinician by allowing an evaluation that incorporates a review of risk factors into the T-score based interpretation. It is based on the Frax[®] paper charts which were developed by the World Health Organization (WHO) to evaluate fracture risk of patients. The charts were developed by WHO by studying population-based cohorts in Europe, North America, Asia, and Australia.

Two sets of charts were developed by WHO for use by clinicians, a set based on Bone Mineral Density (BMD), and a set based on Body Mass Index (BMI). Since better characterization of the Ten Year Fracture Risk is provided by the BMD charts, this data is used to calculate the Ten Year Fracture Risk by the Illuminatus DXA software. The data sets based on the BMD use a fixed value for BMI of 24. Note that for patients that have a much lower BMI (less than 20), the actual Ten Year Fracture Risk may be greater than calculated.

The Ten Year Fracture Risk feature provides a Ten Year Hip Fracture Risk and a Ten Year Major Osteoporotic Fracture Risk. The hip fracture risk is provided to aid the clinician in assessing how to best proceed with interpreting a T-score based treatment strategy. In general, when interpreting data from a US population a Ten Year Hip Fracture Risk of greater than 3% justifies raising the aggressiveness of the T-score based treatment strategy. As guidelines have not yet been developed for interpretation of Ten Year Major Osteoporotic Fracture Risk, that information is provided for informative purposes only.

The Ten-Year Fracture Risk feature is specifically designed for assessment of subjects that are at least 50 years old. When subjects with an age below 50 are processed, the Ten-Year Fracture Risk Program will process the risk analysis based on an age of 50. Note that for those patients the actual Ten Year Fracture Risk may be greater than calculated.

This chapter discusses the following.

Ten Year Fracture Risk Demographics	12-2
Ten Year Fracture Risk Questionnaire	12-3
Ten Year Fracture Risk Confirmation	12-5
Generate and Print a Report	12-6
A Sample Ten Year Fracture Risk Report	12-9

Ten Year Fracture Risk Demographics

The proper demographic information must be provided to create a Ten Year Fracture Risk assessment. See "Preparing Patient Records" on page 4-21 for a thorough explanation of how to enter patient information.

The screenshot displays the 'Illuminatus DXA 4.3.0' software interface. The main window is divided into several sections:

- Patient Demographics:** Includes fields for Last Name (Jackson), First Name (Sue), Patient ID (213242546), Gender (Female), Ethnicity (Caucasian), Date of Birth (4/13/1960), Address (123 Hope Street), City (Anytown), State (CA), ZIP (99955), Phone (999-999-1234), and Accession Number.
- Medical History:** Includes Menopause Year, Bone History (checked), Treatment, Osteoporosis Medications (checked), Technologist (Fuller), Physician (Dr. Smith), and Referring Physician (Dr. Jones).
- Visit Information:** Includes Height (57) and Weight (134).
- Billing Information:** Includes Health Code.
- Comments:** A text area containing 'Ten Year Fracture Risk Assessment'.

At the bottom of the window, there are buttons for 'Save', 'Clear Edits', 'Fracture Risk Questionnaire', '<< Patient List', 'Scan View >>', and 'Stamp View >>'. The status bar at the very bottom shows 'Service', 'Report Template: Ten Year Fracture Risk Report', and 'Scanner Present'.

The following items must be entered to create a Ten Year Fracture Risk assessment:

- » Gender
- » Ethnicity
- » Date of Birth
- » Fracture Risk Questionnaire

The Fracture Risk Questionnaire button opens the Ten Year Fracture Risk Questionnaire, which is used for entering the ethnicity and risk factors used to calculate the Ten Year Fracture Risk for the patient.

Ten Year Fracture Risk Questionnaire

The Ten Year Fracture Risk Questionnaire must be filled out to create a Ten Year Fracture Risk assessment. Once the questionnaire has been filled out, the information is passed to subsequent visits; therefore the questionnaire does not have to be filled out if a patient with a previous Ten Year Fracture Risk assessment has no change in risk factors.

Ten Year Fracture Risk Questionnaire

Ethnic Group

Check all items that apply:

- Previous Fracture - The presence in adulthood of a prior spontaneous fracture or a fracture arising from from light trauma
- Glucocorticoids - Treatment with oral glucocorticoids for over three months at a daily dose of 5mg or more
- Parent Fractured Hip - A history of hip fracture (in the absence of significant trauma) in a parent
- A confirmed diagnosis of Rheumatoid Arthritis
- A confirmed diagnosis of Insulin Dependant Diabetes
- Osteogenesis Imperfecta in adulthood
- Long Standing Untreated Hyperthyroidism
- Hypogonadism
- Premature Menopause - Age less than 45 years
- Chronic Malnutrition
- Malabsorption
- Chronic Liver Disease
- Current Smoker
- Alcohol Use - Consumption of three or more units of the following:
A standard glass of beer, a single measure of spirits, a medium glass of wine, or an aperitif

Save Cancel

Ethnic Group

Select the Ethnic Group that is to be used for the Ten Year Fracture Risk assessment. Note that this ethnic group selection is different from the selection made in the Patient Demographics screen, which is used to calculate the T-score. Only the groups shown in the list are available. If the patient's ethnic group is not listed, use the ethnic group for which the epidemiology of osteoporosis most closely approximates the patient's ethnic group. Very high risk is represented by Sweden and US. High risk is represented by the UK and Italy. Moderate risk is represented by China, Spain, France and Japan. Low risk is represented by Turkey.

Risk Factors

Risk Factors are classified as High Risk, Moderate Risk, and Low Risk. The following risk factors are available for selection:

- » Previous Fracture: The presence in adulthood of a prior spontaneous fracture or a fracture arising from light trauma is cause for increased risk. A positive response is graded as a High Risk Indicator.
- » Glucocorticoids: A report of exposure to oral glucocorticoids or exposure to oral glucocorticoids for over three months at a daily dose of 5mg or more is considered an indicator of risk. A positive response is graded as a High Risk Indicator.
- » Parent Fractured Hip: The presence of a hip fracture--in the absence of significant trauma--in a parent is cause for increased risk. A positive response is graded as a Moderate Risk Indicator.
- » Rheumatoid Arthritis: A report indicating the patient has a confirmed diagnosis of rheumatoid arthritis is considered an indicator of risk. A positive response is graded as a Moderate Risk Indicator.

- » Secondary Osteoporosis: A report indicating the patient has a confirmed diagnosis for Insulin Dependant Diabetes, Osteogenesis Imperfecta in Adults, Long-Standing Untreated Hyperthyroidism, Hypogonadism, Premature Menopause (<45 years), Chronic Malnutrition, Malabsorption or Chronic Liver Disease is considered to have an indicator of risk. The Ten Year Fracture Risk Questionnaire lists each of these secondary causes individually. A positive response on any cause results in a grading as a Moderate Risk Indicator.
- » Current Smoking: A report of current smoking is considered an indicator of risk. A positive response is graded as a Low Risk Indicator.
- » Alcohol Use of 3 or More Units per Day: A report indicating the patient is taking a standard glass of beer, a single measure of spirits, a medium-sized glass of wine of an aperitif daily is considered to have an indicator of risk. A positive response is graded as a Low Risk Indicator.

After the Ethnic Group and Risk Factors have been entered, select to put the changes in the Questionnaire into effect. Select to discard the changes.

Ten Year Fracture Risk Confirmation

Upon exiting the Patient Demographics screen, a confirmation screen is displayed listing all the factors used to calculate the Ten Year Fracture Risk. It is important to verify that all the information listed is correct; otherwise a possible misdiagnosis could be made.

Ten Year Fracture Risk Demographics Verification

Warning:

If information used to calculate the Ten Year Fracture Risk was entered incorrectly it could lead to a possible misdiagnosis. Please verify that the following information is correct:

Patient Name	Jackson, Sue
Patient ID	213243546
Patient Age	49 years
Patient Sex	Female
Reference Set Ethnicity	Caucasian
Ten Year Fracture Risk Ethnicity	US Caucasian

Patient has a parent who has had a previous hip fracture.
Patient has a confirmed diagnosis of Secondary Osteoporosis.
Patient is a current smoker.

Patient has not had a previous fracture.
Patient has not received treatment with oral Glucocorticoids.
Patient does not have a confirmed diagnosis of Rheumatoid Arthritis.
Patient's alcohol use is less than 3 units per day

Is the information shown correct?

The information is grouped into three separate sections:

- » Demographic Information - this includes the patient name, patient ID, age, sex, and ethnicities.
- » Risk factors that apply to the patient.
- » Risk factors that do not apply to the patient.

Select to advance to the next screen. Select to return to the Patient Demographics screen if any information is incorrect so that it can be modified.

Generate and Print a Report

A Ten Year Fracture Risk Report can only be generated for hip scans. When saved, these reports become part of the scan data.

To generate a report for a scan that was just analyzed and saved, click **Report** while viewing the Scan Results. Note that the default report template must be set to Ten Year Fracture Risk Report prior to performing the scan.

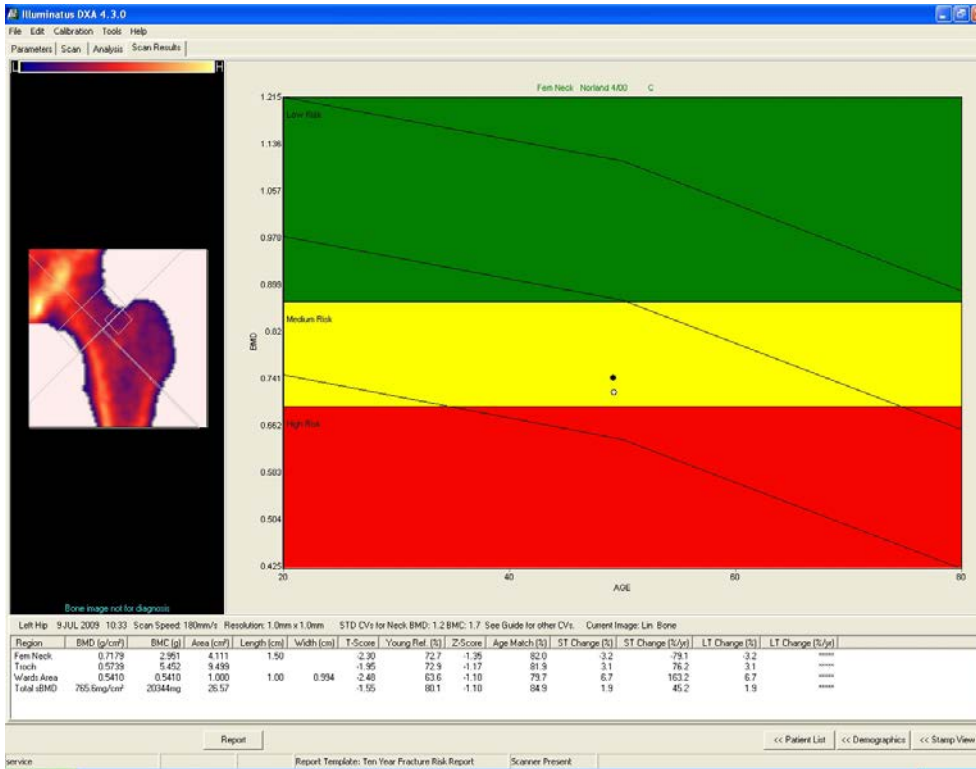

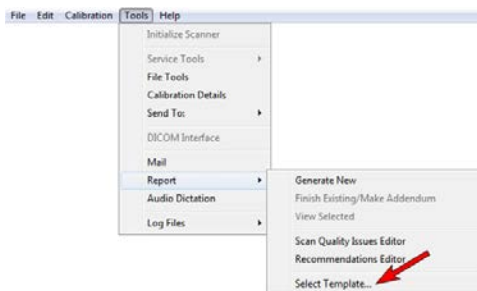

To generate a report for a scan that was previously analyzed and saved:

1. Make sure that the scanned image is being viewed as a thumbnail in the **Stamp View** or the **Filmstrip View**. Click (to highlight) the thumbnail view of the scan.
2. Click **Tools > Report > Select Template...** or click the **Select Template** button to open the "Report Configuration" dialog box.

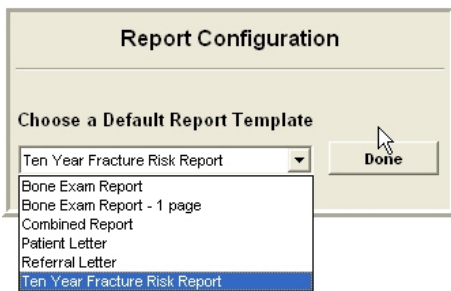

3. When the **Report Configuration** dialog box opens, click the *Ten Year Fracture Risk Report* template to select it. Click .



 **Note:** The selected Report Template will remain the default until it is changed. The currently selected Report Template is always displayed at the bottom of the IlluminatusDXA window.

4. Click **Tools > Report > Generate New** or click the  button.

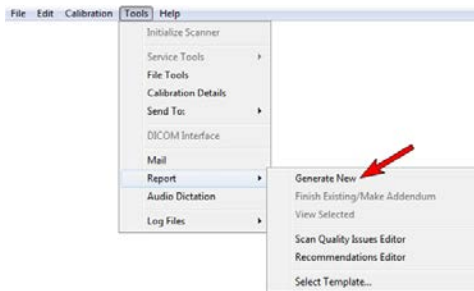

5. The Report is immediately generated and opens up in the window, as shown. At this point, the operator can *Lock* it, *Save* it, *Print* it, *Export* it to a PDF file (or a DICOM file) and *Close* it.

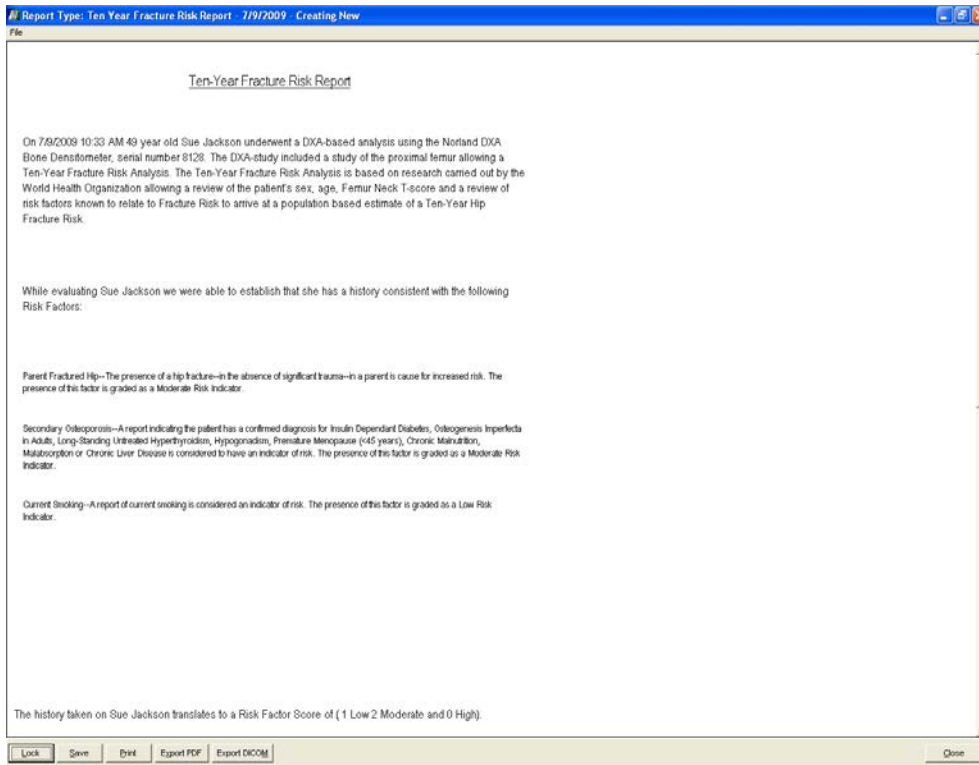

6. Click . The "Print" window appears. Select a printer, select which pages to print and choose how many copies to print.
7. Click to print the Report. The Report is automatically saved and printed.
8. Click .
9. You are returned to the Filmstrip view screen. The saved Report can be found under the "Reports" tab. The Report can be viewed, modified and reprinted at any time. See "The "Reports" Tab" on page 2-14 for more information.

A Sample Ten Year Fracture Risk Report

A sample *Ten Year Fracture Risk Report*:

Norland at Swissray			
W6340 Hackbarth Road Fort Atkinson, WI 53538 USA (888) 741-0413			
<hr/>			
Ten-Year Fracture Risk Report			
Patient Name:	*Hip.good left	Patient ID:	Left Hip
DOB:	11/9/1926	Gender:	Female
Age:	68 years	Referred By:	
Test Date:	11/6/1995		
<hr/>			
<p>On 11/6/1995, left *Hip.good underwent a DXA-based analysis using the Norland DXA Bone Densitometer, serial number 6746. The DXA-study included a study of the proximal femur allowing a Ten-Year Fracture Risk Analysis. The Ten-Year Fracture Risk Analysis is based on research carried out by the World Health Organization allowing a review of the patient's sex, age, Femur Neck T-score and a review of risk factors known to relate to Fracture Risk to arrive at a population based estimate of a Ten-Year Hip Fracture Risk.</p>			
<p>While evaluating left *Hip.good we were able to establish that she has a history consistent with the following Risk Factors:</p>			
<p>Glucocorticoids--A report of exposure to oral glucocorticoids or exposure to oral glucocorticoids for over three months at a daily dose of 5mg or more is considered an indicator of risk. The presence of this factor is graded as a High Risk Indicator.</p>			
<p>Parent Fractured Hip--The presence of a hip fracture--in the absence of significant trauma--in a parent is cause for increased risk. The presence of this factor is graded as a Moderate Risk Indicator.</p>			
<p>Rheumatoid Arthritis--A report indicating the patient has a confirmed diagnosis of rheumatoid arthritis is considered an indicator of risk. The presence of this factor is graded as a Moderate Risk Indicator.</p>			
<p>Secondary Osteoporosis--A report indicating the patient may have any of the following conditions (Insulin Dependant Diabetes, Osteogenesis Imperfecta in Adults, Long-Standing Untreated Hyperthyroidism, Hypogonadism, Premature Menopause (<45 years), Chronic Malnutrition, Malabsorption or Chronic Liver Disease) and is considered to have an indicator of risk. The presence of this factor is graded as a Moderate Risk Indicator.</p>			
<hr/>			
NORLAND			

Figure 12-1: Page 1 of the Ten Year Fracture Risk Report

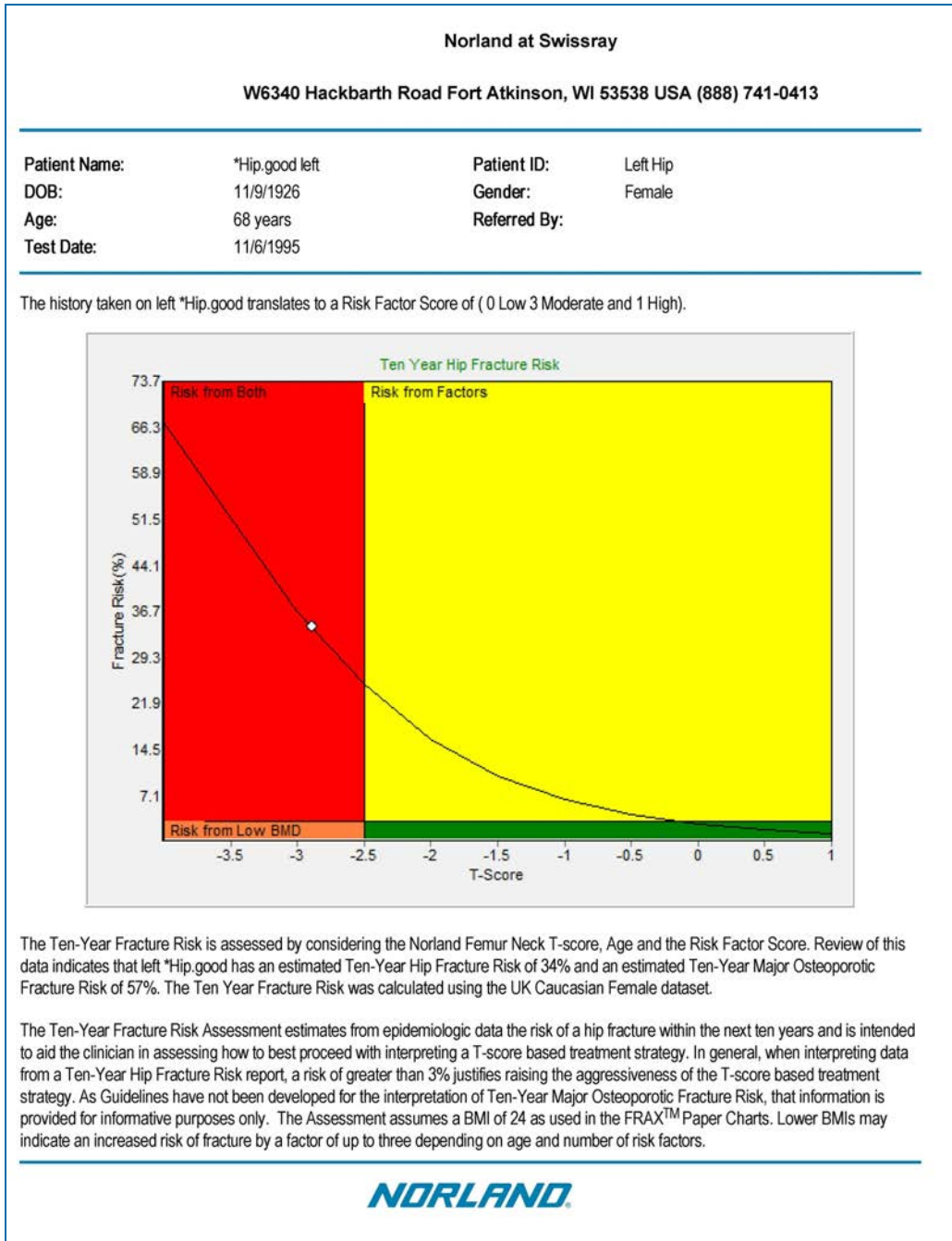

Figure 12-2: Page 1 of the Ten Year Fracture Risk Report

CHAPTER 13

DICOM Interface



Note: The DICOM Interface feature is available as an option with the Bone Densitometer. Be aware that your system might not have this option.

DICOM is a global Information Technology standard that is used in virtually all hospitals worldwide. Its current structure, which was developed in 1993, is designed to ensure the interoperability of systems used to **produce, send, retrieve**, store, display, process, query, or print medical images and derived structured documents as well as to manage related workflow.

The Illuminatus DXA DICOM interface supports the first 3 items above, namely, producing and sending of DICOM images as well as retrieving patient work lists from systems supporting the generation of patient work lists.

This chapter discusses the following.

Terms	13-2
Requirements	13-2
Exploring the DICOM Interface	13-3
Quick Reference - DICOM Interface	13-9
Patient Worklist	13-10
Data Patient Conflict	13-13
Exporting DICOM Images	13-14
Pushing and Deleting DICOM Files	13-15
DICOM Job Queue	13-18

Terms

The following definitions are used throughout the document.

DICOM - Digital Imaging and Communications in Medicine

SCP - Service Class Provider

SCU - Service Class User

Requirements

The following are the minimum requirements to enable the DICOM interface in Illuminatus DXA.

Network Address

The Illuminatus DXA computer must be connected to a network and have a valid IP Address assigned in Windows.

OAC Code

An OAC code is required to enable the DICOM software in Illuminatus DXA. Refer to "Scanner Preferences Command" on page 3-21 to configure an OAC code.

PACS and Worklist Server Setup

The Illuminatus DXA SCU may need to be granted access on the PACS and Worklist servers. Contact your Network Administrator to be granted access on all necessary systems.

Exploring the DICOM Interface

How to Invoke the DICOM Interface

In the Database Navigator window, click **Tools > DICOM Interface**. The “Illuminatus DICOM files” window will appear, and will show the DICOM files that have been previously exported from DXA.

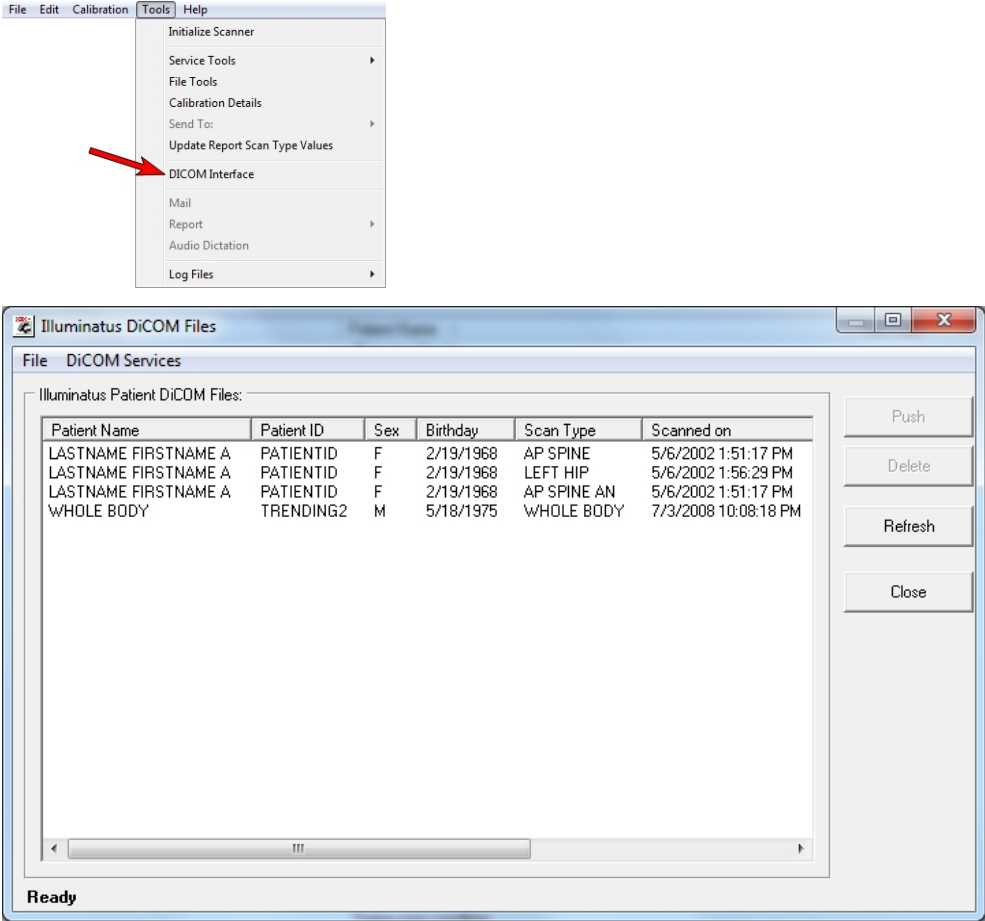

Figure 13-1: Illuminatus DICOM Patient Files

DICOM Preferences Dialog Box: the Site Tab

In the DICOM window, select **File > DICOM Preferences**. The Illuminatus DICOM Preferences dialog box opens (shown below with the Site tab selected).

This DICOM Preferences dialog box allows the user to configure various aspects of the Illuminatus DICOM utility. Each tab is discussed next.

The screenshot shows the 'Illuminatus DiCOM Preferences' dialog box with the 'Site' tab selected. The 'Site Information' section contains the following fields: 'Local AE Title' (ILLUMINATUS_1), 'Retry Delay' (30), 'Retry Limit' (2), and a checkbox for 'Delete DiCOM File after Successful Transfer?'. The 'Modality Worklist' section contains: a checked checkbox for 'Enable Modality Worklists?', 'Remote AE Title' (DCM4CHEE), 'Local AE Title' (ILLUMINATUS_1), 'Remote IP Address' (192.168.16.5), 'Retrieval Limit' (100), and 'Remote Port' (11112). Buttons at the bottom include Print, OK, Cancel, Apply, and Help.

Figure 13-2: *Illuminatus DICOM Preferences - Site tab*

The “Site Information” Section

The Site Information area contains information about the Illuminatus DICOM system.

- » The **Local AE Title** should not be changed unless instructed by your Network Administrator.
- » The **Delete DICOM File after Successful Transfer** check box indicates whether or not you would like the DICOM interface to automatically delete DICOM files after they have been successfully transmitted. If this option is turned on and the user sends reports to multiple destinations and one fails, the report will be removed from the queue after its retry limit has been reached. If this occurs, the report must be regenerated before it can be sent again.
- » The **Retry Delay** indicates the delay (in seconds) between transmission retries for failed transfers.
- » The **Retry Limit** indicates the number of retries the system will perform before giving up on attempting to transfer the DICOM file.

The “Modality Worklist” Section

The Modality Worklist area allows the user to configure the worklist server for Illuminatus DICOM.

The screenshot shows the 'Illuminatus DICOM Preferences' dialog box with the 'Site' tab selected. The 'Site Information' section includes a text field for 'Local AE Title' containing 'ILLUMINATUS_1', a spinner for 'Retry Delay' set to 30, a spinner for 'Retry Limit' set to 2, and an unchecked checkbox for 'Delete DiCOM File after Successful Transfer?'. The 'Modality Worklist' section has a checked checkbox for 'Enable Modality Worklists?'. Below it, the 'Local AE Title' is 'ILLUMINATUS_1' and the 'Retrieval Limit' is 100. The 'Remote AE Title' is 'DCM4CHEE', the 'Remote IP Address' is '192.168.16.5', and the 'Remote Port' is '11112'. Buttons for 'Print', 'OK', 'Cancel', 'Apply', and 'Help' are at the bottom.

Figure 13-3: *Illuminatus DICOM Preferences - Site tab*

- » If the **Enable Modality Worklists?** check box is checked, the fields in this section will become enabled for editing.
- » The **Local AE Title** should not be changed unless instructed by your Network Administrator.
- » The **Retrieval Limit** indicates the maximum number of returned results within a single query.
- » The **Remote AE Title** indicates the AE Title of the worklist generator on your network.
- » The **Remote IP Address** indicates the IP address of the worklist generator on your network.
- » The **Remote Port** indicates the port of the worklist generator on your network.

DICOM Preferences Dialog Box: the DICOM Devices Tab

In the DICOM window, select **File > DICOM Preferences**. In the "Illuminatus DICOM Preferences" window, click the DICOM Devices tab.

This window allows the user to configure one or more Service Class Providers (devices) to communicate with.

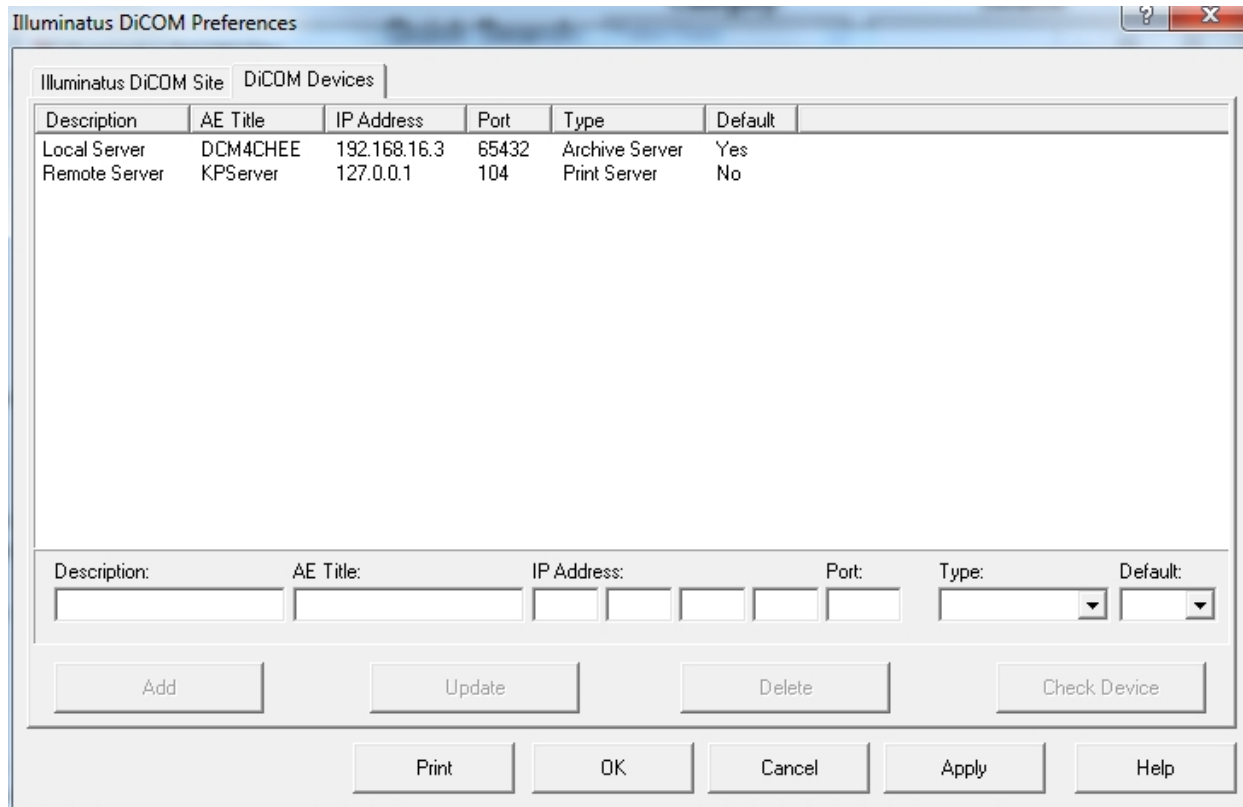

Figure 13-4: Illuminatus DICOM Preferences - Devices tab

- » The **Description** is any arbitrary text you wish to use. This description field will be what is visible to the user when selecting a target device or viewing the DICOM Queue.
- » The **AE Title** is the AE Title of the remote SCP.
- » The **IP Address** is the IP address of the remote SCP.
- » The **Port** is the port of the remote SCP in which data is transferred to.
- » The **Type** indicates whether the destination device is an Archive Server, Workstation, or Print Server. These choices are available simply for your benefit, the Illuminatus DICOM interface operates the same for all three types of devices.
- » The **Default** indicates whether or not to include device in the default destination group during a Push operation.
- » The **Add** button: Once the required fields are populated, pressing the Add button will add the newly configured device to the list of DICOM devices.
- » The **Update** button: To update an existing device, first select the device you wish to modify, make the changes and click the Update button. Your changes will take effect immediately.

- » The **Delete** button: To delete an existing device, first select the device you wish to delete, and press the Delete button.
- » The **Check Device** button: To check a device to see if it is active and is communicating with Illuminatus DICOM, select the configured device and press the Check Device button. A message will be returned indicating its status.
- » There are only three possible return values from checking a device:
 1. Device Not Responding
 2. Device Responding (Compression Supported)
 3. Device Responding (Compression Not Supported)
- » Once you have configured your DICOM Devices, you can begin exporting the DICOM reports and pushing them to your SCPs.

Advanced Preferences

In the Database Navigator window, click **Edit > Advanced Preferences**. In the DICOM tab, the compression setting can be selected. The default selection “No Compression” can be changed if it is not supported by your archive server.

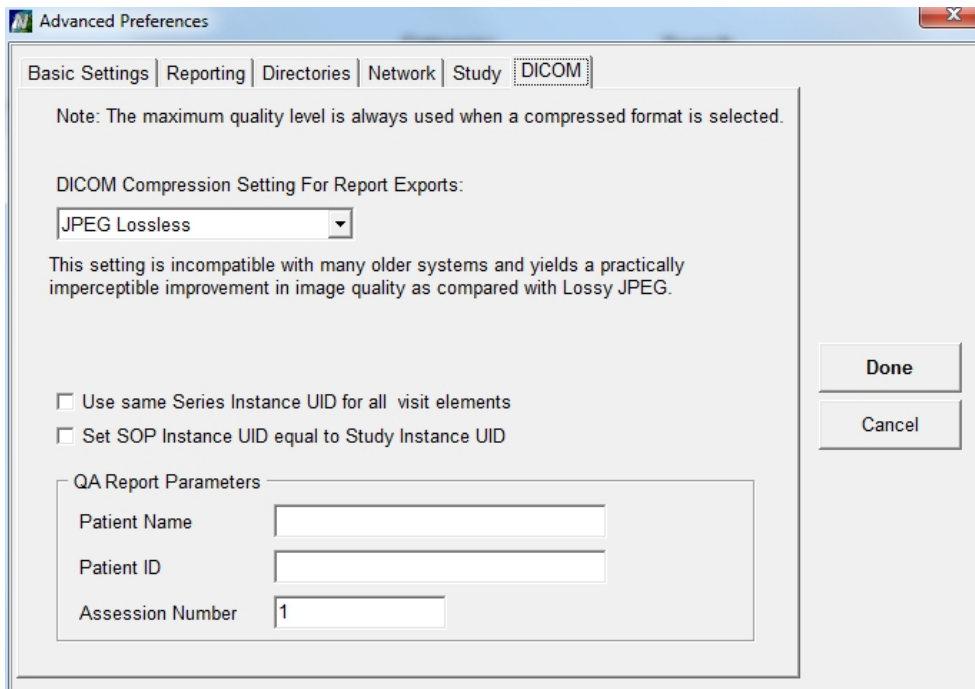

Figure 13-5: Advanced Preferences - DICOM tab

The following **Compression** selections are available:

- » JPEG Lossy
- » JPEG Lossless
- » RLE
- » JPEG-2000 Lossless
- » JPEG-2000 Lossy
- » No Compression (*default*)

The checkbox for “**Use same Series Instance UID for all visit elements**” can be turned on if you prefer to have all DICOM images for one patient’s visit to use the same Series Instance UID value so the images will appear on the PACS as part of one series of images.

The checkbox for “**Set SOP Instance UID equal to Study Instance UID**” can be turned on if your DICOM images are not being successfully transferred to the PACS. This setting may be required for compatibility with some PACS servers.

If QA reports are to be exported to DICOM files, the **Patient Name**, **Patient ID**, and **Accession Number** for the QA report may be entered. If no values are entered, the following default values are used:

- » Patient Name: QA Report
- » Patient ID: QAReport
- » Accession Number: 1

Modality Value

When creating DICOM reports, the Modality value will default to “OT” (“Other”). To change the Modality value to be used on all reports, edit the file Preferences.ini in the IlluminatusDXA software installation folder. Search for the setting “DefaultModalityType”. Change the setting to the value required for your PACS. If the setting DefaultModalityType does not exist in the file, enter it on a new line at the end of the file in the format below, replacing BMD with your value.

DefaultModalityType=BMD

Note that this setting will be used for all destination devices and cannot be configured separately if multiple destination devices are configured. The setting entered in the Preferences.ini file must be compatible with all configured DICOM devices.



Caution: Make a backup of all files before modifying the Preferences.ini file. Changing values other than those described here can cause unintended software behavior. Contact Technical Support for assistance if you are unsure about making these changes.

Quick Reference - DICOM Interface

Patient Worklist

- » Start the IlluminatusDXA software.
- » From the Patient Visit List screen, click **Tools menu > DICOM Interface**.
- » In the Illuminatus DICOM Files window, click **DICOM Services menu > Patient Worklist**.

Query Parameters:
Enter values to define the query you wish to execute (Blank fields will match any value)
* = Wildcard

Last Name, First Name: Patient ID: Modality Name: Start Date: Start Time:
Requested Procedure ID: Physician: Accession No.: End Date: End Time:
 Single Word in Patient Name
 Use saved search values
Query Date? Query Time?

Query Results:
Patient Results from Query (Click on a Column to change the sort order)

Patient Name	Patient ID	Sex	Birthday	Physician	Accession Number	Scheduled for
DANIELS, DAVID U.	K888888	M	8/8/1938	JOHN*DR.	888888888888	12:45:00 PM
CROSS, CATHERINE F.	K555555	F	5/5/1935	JOHN*DR.	555555555555	12:45:00 PM
CROSS, CATHERINE F.	K555555	F	5/5/1935	JOHN*DR.	555555555553	12:45:00 PM
CROSS, CATHERINE F.	K555555	F	5/5/1935	JOHN*DR.	5555555555578	12:45:00 PM
BROWN, BENJAMIN R.	K333333	M	3/3/1933	JOHN*DR.	333333333333	12:34:00 PM
BROWN, BENJAMIN R.	K333333	M	3/3/1933	JOHN*DR.	333333333334	12:34:00 PM
ANDERSON, ANN A.	K111111	F	1/1/1931	JOHN*DR.	111111111111	12:34:00 PM
ANDERSON, ANN A.	K111111	F	1/1/1931	JOHN*DR.	111111111112	12:45:00 PM

- » Click the Query button to search for all available studies.
- » If you need to filter results based on the Patient Name, Patient ID, Scheduled Date or other fields, enter the information into the search boxes and click Query.
- » All available matching results will be displayed at the bottom of the window.
- » You may click the “Save All” button to save all worklist results to your patient database, or highlight one or more entries and click “Save”.

Exporting and Pushing DICOM Reports

- » After completing and analyzing a patient scan, generate a report.
- » When the report is displayed, click the “Export DICOM” button. At the confirmation message click OK.
- » Close the report preview, and return to the Patient List.
- » Click the Tools menu and DICOM Interface.
- » A list of all available DICOM reports will be displayed. Highlight one or more reports you wish to send and click Push.
- » If your configuration is set to delete DICOM reports after they are sent successfully, click Refresh to verify the reports are removed from the list and sent successfully.

Patient Worklist



Note: Prior to querying the DICOM Worklist, check the Patient List to determine if the Patient ID must be updated. If the Patient ID in the database does not match the Patient Worklist, the records will not be matched, and this may adversely affect patient trending.

When the user selects **Patient Worklist** from the **Illuminatus DICOM Services** menu, the system will display the **Illuminatus DICOM Patient Worklist** window.

Figure 13-6: Illuminatus DICOM Patient Worklist

The Worklist window contains several user-editable fields. In the **Query Parameters** area, various fields can be edited and passed to the Worklist server as query parameters. This would help limit the data returned, if the user knew the specific details of the patients they were searching for. If too many results are returned, you may enter additional parameters and click Query again to refine your search.



To save the Parameters as defaults the next time the Worklist window is opened, click the **Used saved search values** box. To clear the Parameters, uncheck the **Used saved search values** box and Close the Patient Worklist window.

The format of the Patient Name search field is “Last Name, First Name”, and the asterisk “*” can be used as a wildcard to broaden the search. To use a single search value such as last name only, check the box **Single Word in Patient Name**.

The **Start Time** and **End Time** will not be used unless the **Query Time?** box is checked. The values will default to 12:00:00 AM and 11:59:59 PM when the Worklist dialog box is opened, or if the Clear button is pressed.

The **Start Date** and **End Date** will not be used unless the **Query Date?** box is checked. The values will default to the current date when the Worklist dialog box is opened, or if the Clear button is pressed.

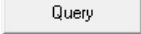
Query / Cancel

When the user presses the  button, the query will begin executing. The Query button's caption will change to  while a query is in progress. This will allow the user to cancel the current query that is in progress.

The query will return one of three possible responses:

1. No Results

If no results match the criteria selected, then the system will display a dialog indicating such as shown in Figure 13-7, left.

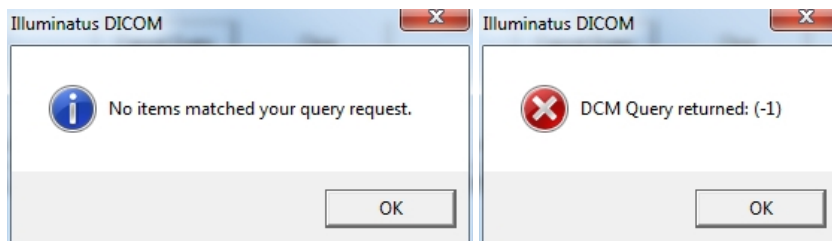

Figure 13-7: No Query Results (left) vs. Error in Query (right)

2. Error in Query

If an error occurs in the query or the query can not be performed for one reason or another, the system will return an error code to the user as shown in Figure 13-7 above, right. If the Worklist Query cannot be performed, the user may not be able to retrieve the patient information from the Worklist server, and the patient may need to be entered manually. Refer to "Preparing Patient Records" on page 4-21 for detailed instructions on adding or updating a patient manually.

If the user encounters this message, there may be a configuration problem for the DICOM Worklist settings. Verify your Worklist settings in the DICOM Preferences window. Refer to "DICOM Preferences Dialog Box: the Site Tab" on page 13-4. If the problem persists, contact Technical Support.

3. Query Results Area

Should the system successfully execute a query, the results will be returned to the Illuminatus DICOM Patient Worklist dialog box and populated in the Query Results area as shown in Figure 13-8:

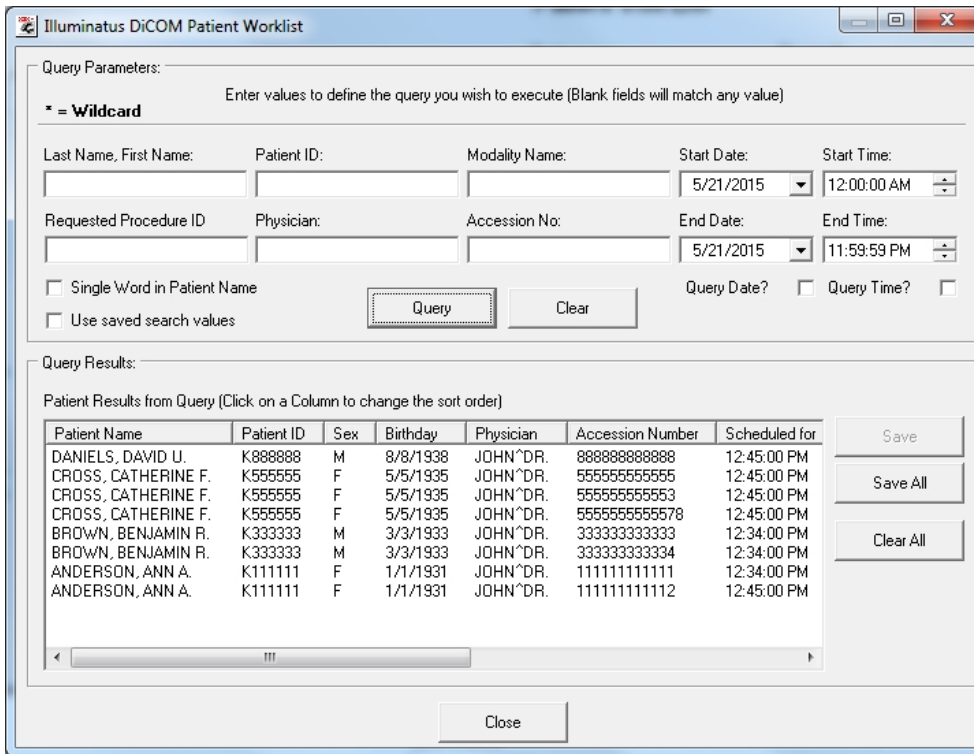

Figure 13-8: Patient Worklist dialog box populated

Clear: Click the Clear button to clear all Query Parameters, reset the Date and Time filters to default values, and clear all patients from the Query Results section.

Save: When results are returned to the user, the user may select one or more of the returned items and click the Save button. This will save the selected patients to the currently active Illuminatus DXA database.

If there are multiple databases configured in Illuminatus DXA, be sure the correct database is selected before saving any results.

If the patient record already exists, and the Patient Name, ID, Date of Birth, and Gender all match, no changes will be made to the patient record. If these values are different, a Data Patient Conflict message will appear. See "Data Patient Conflict" on the facing page.

Save All: If all of the returned records are to be saved to the Illuminatus DXA database, then simply clicking the Save All button will perform the action.

Clear All: By pressing the Clear All button, the user can clear out all of the returned query results.

After saving the necessary patients to your database, return to "Preparing Patient Records" on page 4-21 to begin the scanning process.

Data Patient Conflict

When a patient entry is saved to your active database, it will be compared to all existing records. If the ID matches an existing patient record, but the Name, Date of Birth, or Gender does not match, the **Data Patient Conflict** dialog box will be displayed. Differences in capitalization may show a conflict, even if the spelling is exact.

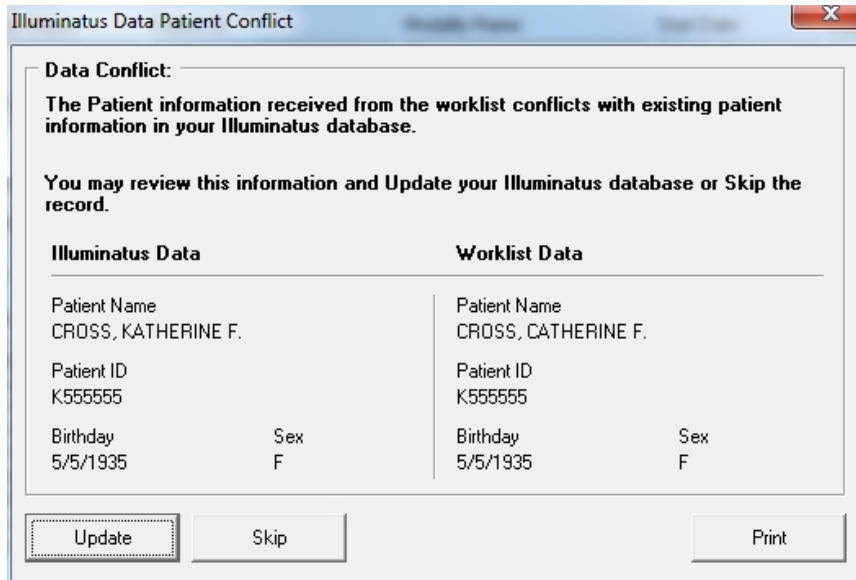

Figure 13-9: Data Patient Conflict dialog box

Update: The user has the option to update the patient records already in the system with the information from the worklist data. Only the Name, Date of Birth, and Sex will be modified. All other patient demographic information will not be modified. If multiple query results are selected to be saved, Illuminatus DXA will continue to import with the next record if the Update button is pressed.

Skip: The user may skip the current record, and no changes will be made to the existing patient data. If multiple query results are selected to be saved, Illuminatus DXA will continue to import with the next record if the Skip button is pressed.

Print: The user may print the information that appears on the screen for review or modification. The user must then *Update* or *Skip* the record to continue to save patient data from the worklist.

Exporting DICOM Images

When a report is generated in Illuminatus DXA and the DICOM OAC option has been entered, the Export DICOM button will be visible and enabled as shown in Figure 13-10.

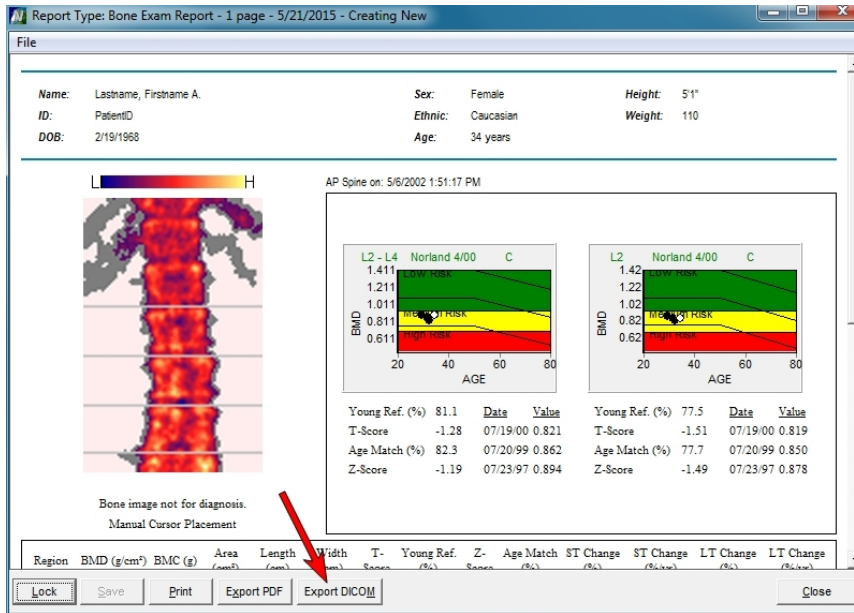

Figure 13-10: The Export DICOM button

The **Export Dicom** button will create a DICOM file in the DICOM folder (configured in Advanced Preferences), typically C:\IlluminatusDXA\DICOM.

The DICOM interface will look for DICOM files in this directory.

Pushing and Deleting DICOM Files

When the user invokes the DICOM Interface menu item and the Illuminatus DICOM Files dialog box appears, they may perform several operations.

The system will allow the user to select one or more entries from the Illuminatus Patient DICOM Files listing. To select more than one item, hold the <Ctrl> key while clicking each item. When one or more items have been selected, the and buttons become enabled.

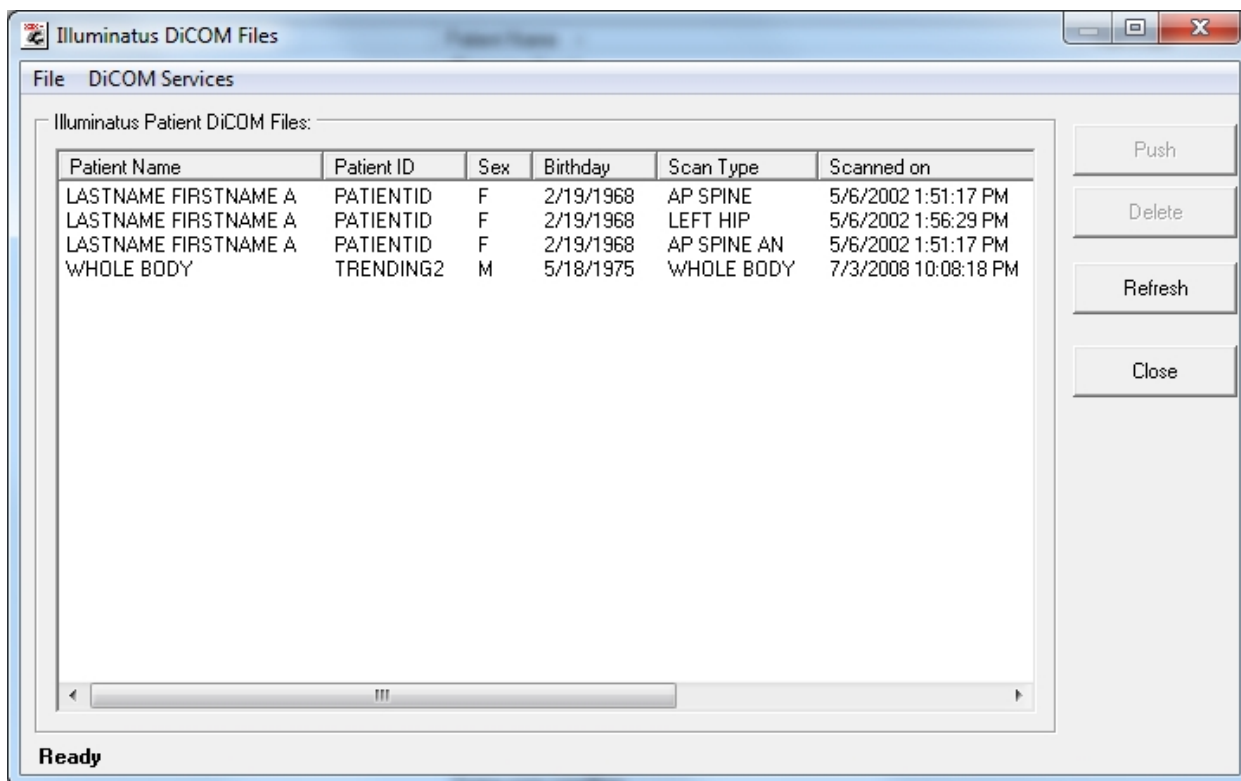



Figure 13-11: Illuminatus DICOM Files window

The Push Operation

The  button will be enabled when one or more items are selected. An entry in the list can be double-clicked to perform the Push function.

When one or more reports are pushed, the system will check to see if any DICOM devices have been configured.

1. No Devices Configured

If no devices have been configured, the system will display a message to the user indicating that no DICOM Devices have been configured. Refer to "DICOM Preferences Dialog Box: the DICOM Devices Tab" on page 13-6 to configure the DICOM Devices.

2. Single Device Configured

If a single device has been configured, the system will queue up the selected items and set their destination to the configured device.

3. Multiple Devices Configured

If multiple devices are configured, the system will display a dialog listing the devices configured.

a. Default Group Configured

If the user has preselected a default group of DICOM Devices to send to, these Devices will be high-lighted in the dialog as shown in Figure 13-12. Pressing the  button will continue the Push operation to those Devices.

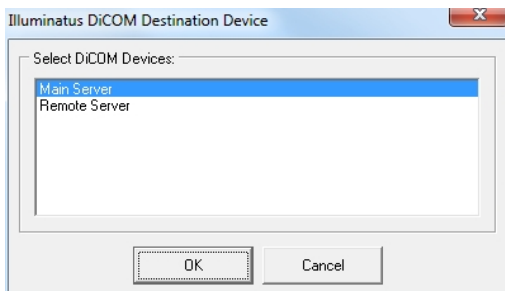

Figure 13-12: Default DICOM Devices configured

b. Default Group Not Configured

If no devices have been preselected as default, then the dialog will be displayed with no devices high-lighted as shown in Figure 13-13 and the user will be forced to select at least one device before continuing with the push operation.

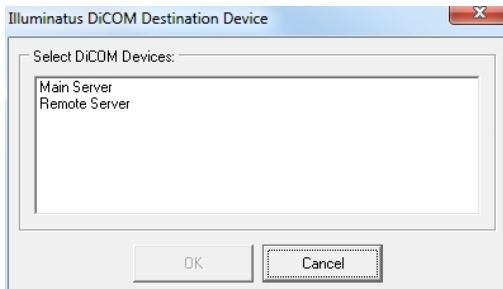





Figure 13-13: No Default DICOM Devices configured

If the user has not checked the *Delete DICOM File after Successful Transfer* option in the DICOM Preferences, the DICOM file will NOT be deleted and will remain in the DICOM File listing until manually deleted by the user.

The Delete Operation

When the user presses the  button, the system will confirm that the selected files are to be deleted, as shown in Figure 13-14.

If the user presses , the files will be deleted. If they press , the files will not be deleted.

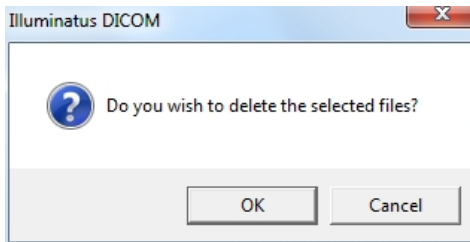

Figure 13-14: DICOM File Delete Confirmation

Refresh

The system will allow the user to manually refresh the DICOM file listing. If the user has selected the option to delete DICOM files after transmitting, this will refresh the list with only the current DICOM files available.

DICOM Job Queue

When the user selects DICOM Queue from the Illuminatus DICOM Services menu item, the system will display the **Illuminatus DICOM Job Queue** dialog box as shown in Figure 13-15.

The Illuminatus DICOM Job Queue dialog box will automatically refresh itself every five seconds, keeping the user informed of the current status of each queued DICOM file.

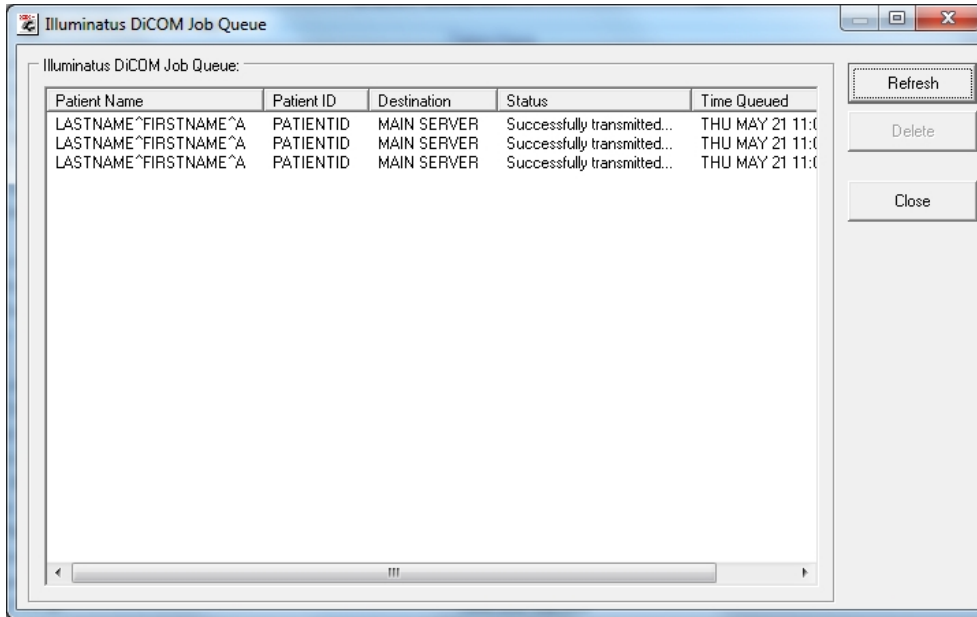

Figure 13-15: Illuminatus DICOM Job Queue

Refresh: The user may press the Refresh button to manually refresh the DICOM queue.

Delete: If the user selects one or more files in the Illuminatus DICOM Job Queue dialog box, the Delete button becomes enabled and the user can delete the selected entries.

The system does not prompt the user to confirm deletion of the *Queued* files. Files that are currently in the *'Transmitting...'* or *'Transmitted Successfully'* state can not be deleted, as they have been completed and will not appear the next time the application is executed.

CHAPTER 14

DB Extract

The DB Extract utility is a separate program that allows the operator to extract the patient's personal and scan data without altering the original data. The data is extracted to a comma separated value file (*.csv) which may be opened using a spreadsheet program such as Microsoft Excel or Google Docs. The data may then be manipulated in any way desired for such tasks as caseload management, patient mailings, statistical analysis, or other purposes.

Although the DB Extract utility is a simple program that performs a simple task, it is not recommended for use by untrained users. DB Extract merely creates a data file that may be safely manipulated by third party programs. No other use is intended or recommended.

An understanding of spreadsheet principles is a prerequisite for working with DB Extract created files. This guide is written for an experienced audience and will not attempt to explain how to use the spreadsheet with the DB Extract created files.

The DB Extract program is installed when Illuminatus DXA is installed. No special setup is required.

This chapter discusses the following.

Opening DB Extract	14-2
Selecting Export Parameters	14-3
Loading and Saving Setups	14-7
Exporting Data	14-8
Patient Personal and Scan Export Parameters	14-9

Opening DB Extract

Click on **Start > Programs > Norland > Extract** to open the DB Extract program. Since the DB Extract program accesses the scanner, scanner files, and patient database, all other Norland applications must be closed prior to opening DB Extract. If the system has any special features such as Soft Tissue Composition, the scanner must be turned on prior to starting the DB Extract program to enable them.



After the program is opened, the DB Extract window is displayed.

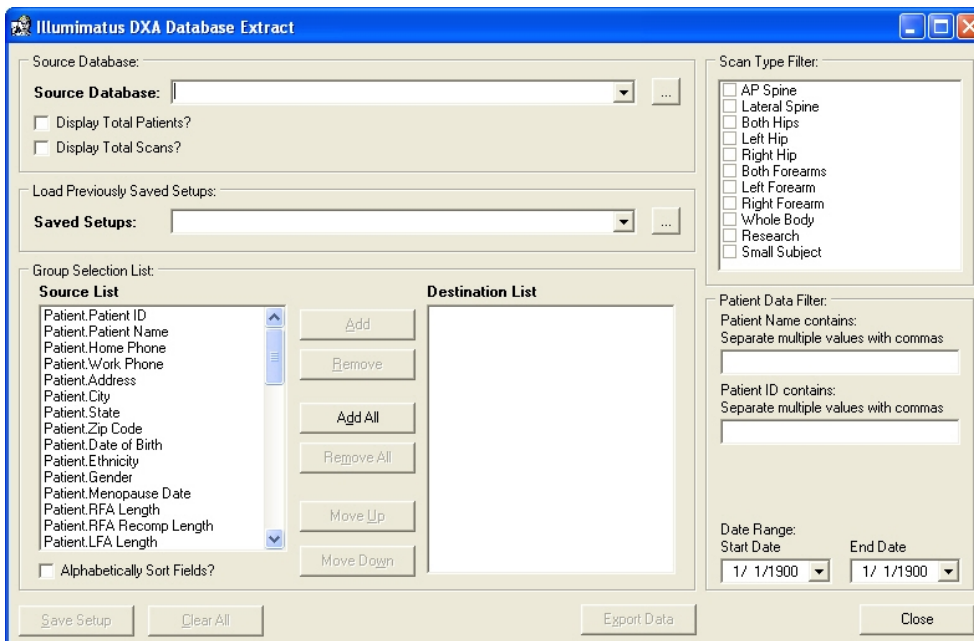

Figure 14-1: The Database Extract window

Selections can now be made to determine the source database, the patient, scan, and region parameters, and which patients are to be exported.

Selecting Export Parameters

Source Database

The Source Database section allows the user to specify the Illuminatus DXA database that the data is to be exported from.

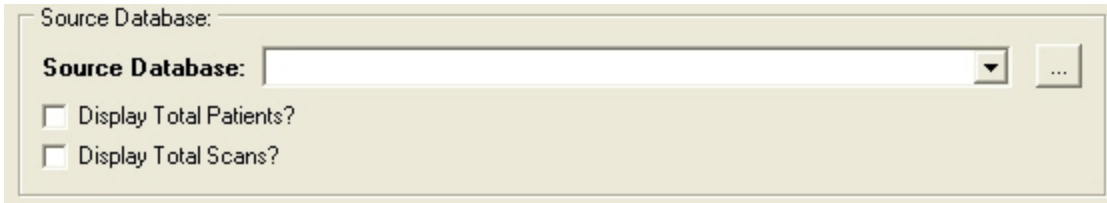

Databases may be selected by clicking on the drop-down arrow and selecting the database. If the database desired is not in the list, the database may be added by clicking the  button and browsing for the directory that the database is located in.

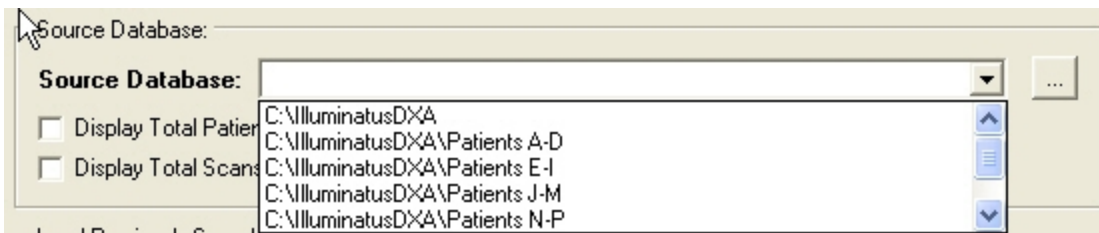

The total patients and the total scans in the database are displayed when the corresponding box is checked.



Patient, Scan, and Region Parameters



A list of the parameters available for export is located in the Source List. When they are selected and added, the items appear in the Destination List. The order of the items in the destination list determines the order of the data columns in the exported file. See "Patient Personal and Scan Export Parameters" on page 14-9 for a complete list and description of the items in the Source List. There are four classifications of parameters:

- » Patient Information - these items can be grouped with Visit information
- » Visit Information - these items can be grouped with Patient Information
- » Scan Information - these items are grouped separately
- » Region Information - these items are grouped separately

Click  to select all parameters available.

Single parameters may be added by double clicking on the selected item or clicking on the desired item, then clicking .



Multiple items may be added in one of two ways:

- » To add items that are grouped together, click the first desired item, press **<Shift>**, and click on the last item to highlight the group. Click  to add the group to the Destination List.
- » To add items that are not grouped together, click the first desired item, press **<Ctrl>**, and click on the individual items that are to be added. Click  to add the group to the Destination List.

Once items have been added to the Destination List, they may be manipulated in various ways. Single and multiple items may be selected in the Destination List as described above.

 deletes the selected item(s) from the Destination List.

 deletes all items from the Destination List.

 or  moves the selected item(s) up or down in the list. Items may only be moved within their respective groups.

Patient Filtering

Patient filtering refers to options that can be selected that define which patients are selected for export. Patients can be filtered by scan type, patient name or patient ID, or scan date.

To export only patients with a certain scan type, select the scan type(s) in the Scan Type Filter section. Multiple scan types may be selected. If no scan types are selected, patients are exported regardless of scan type.

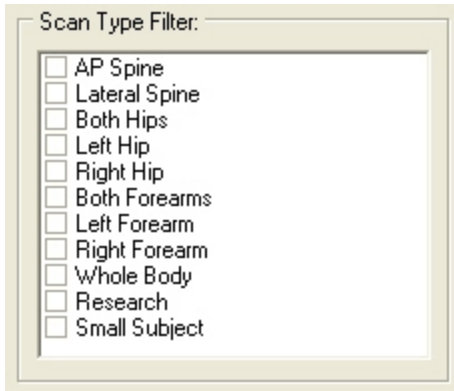

Scan Type Filter:

- AP Spine
- Lateral Spine
- Both Hips
- Left Hip
- Right Hip
- Both Forearms
- Left Forearm
- Right Forearm
- Whole Body
- Research
- Small Subject

To export only patients whose name or ID number contains specific characters, enter the characters in the provided box. Multiple values must be separated by a comma. For example, to export all patients named Smith and Jones, enter *Smith, Jones* in the Patient Name box. If no characters are entered in the Patient Name box or the Patient ID box, patients will be exported regardless of name or ID number.

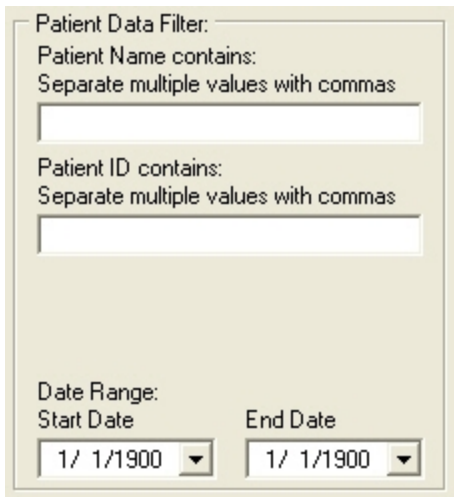

Patient Data Filter:

Patient Name contains:
Separate multiple values with commas

Patient ID contains:
Separate multiple values with commas

Date Range:

Start Date End Date

1/ 1/1900 1/ 1/1900

To export only patients that were scanned during a certain period, enter the start date and the end date in the Date Range boxes. The date may be entered manually or the calendar may be used.

1. To use the calendar, click the drop-down arrow.

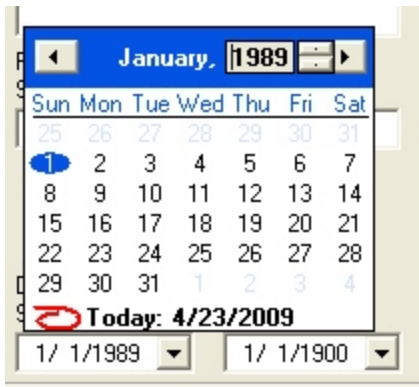

- Click on the year, and then use the arrows that appear to set the year.

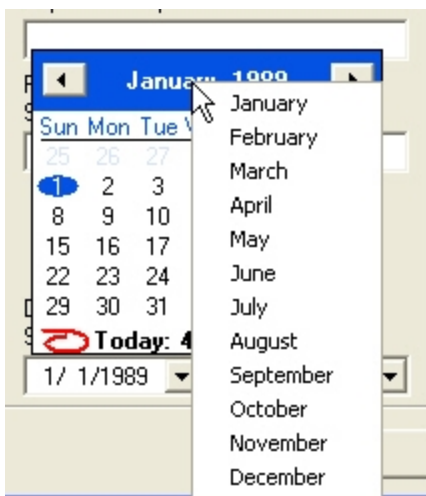

- Click on the month, and a list of months will appear. Select the month from the list and then select the day.

If no dates are entered (the default date of 1/1/1900 is displayed), patients will be exported regardless of scan date. If only a start date is entered, patients who were scanned after that date will be exported. If only an end date is entered, patients who were scanned before that date will be exported.

Loading and Saving Setups

Once the export parameters have been entered, they may be saved for future use. That way the parameters do not have to be reentered during subsequent sessions of DB Extract. This is particularly useful for caseload management or statistical analysis that is done periodically. An example of this would be a facility that tracks how many patients receive hip scans every six months. Rather than having to enter the parameters each time the tracking is done, a setup file could be created that automatically loads the parameters each time they are required.

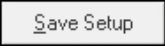
To save the setup, click . Enter a filename for the setup in the Save dialog box that appears.



Previously saved setups may be selected by clicking on the drop-down arrow and selecting the setup file. If the setup file desired is not in the list, the setup file may be selected by clicking the  button and browsing for the directory that the setup file is located in.

Exporting Data

Once the source database, patient, scan, and region parameters and desired filters have been entered, the data may be exported. Click  to begin the export. Enter a name for the file that is to be created.

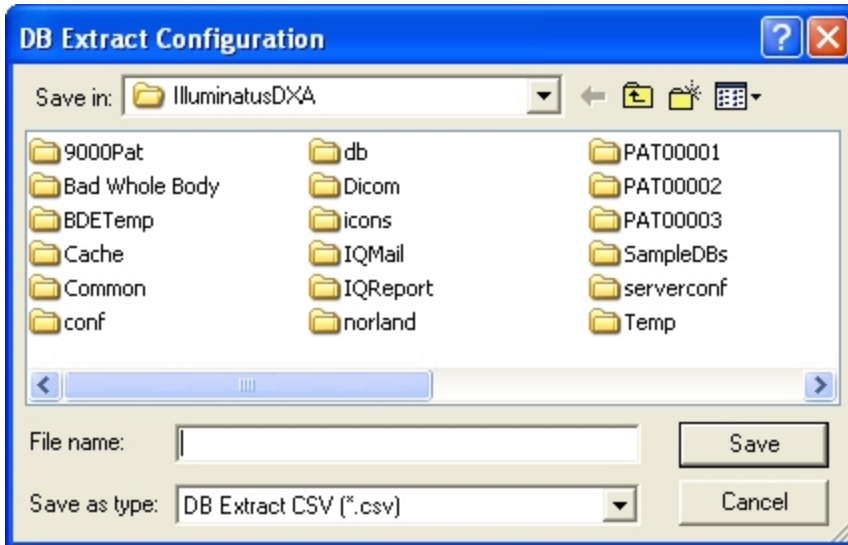

A status box is displayed while the export is being made. An export could take as long as an hour for very large (20,000+ patient) databases, depending on the number of parameters that are to be exported. Once the export has begun it cannot be stopped by the user.

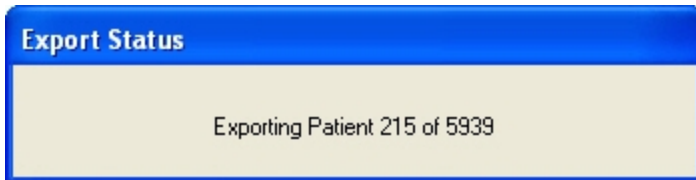

A message is displayed at the end on the export giving the pass/fail status of the export.



The data is now ready to be viewed and manipulated using a spreadsheet program.

Patient Personal and Scan Export Parameters

There are four classifications of data in the Norland database:

- » Patient data that is stored once for the patient and is overwritten when changed.
- » Visit data which applies to each date that the patient was scanned.
- » Scan data that applies to each individual scan performed during the visit.
- » Region data that applies to each individual region of the scan.

Table 14-1: Patient Parameters

Displayed in Source List As:	Displayed in Exported File As:	Description
Patient.Patient ID	Patient_ID	Patient's Unique ID
Patient.Patient Name	Patient_Name	Patient's Name
Patient.Home Phone	Home_Phone	Patient's Home Phone Number
Patient.Work Phone	Work_Phone	Patient's Work Phone Number
Patient.Address	Address	Patient's Street Address
Patient.City	City	Patient's City
Patient.State	State	Patient's State
Patient.Zip Code	Zip_Code	Patient's Zip Code
Patient.Date of Birth	Birth_Date	Patients Birthdate
Patient.Ethnicity	Ethnicity	Patient's Ethnicity
Patient.Gender	Gender	Patient's Gender
Patient.Menopause Date	Menopause_Date	Menopause Onset Year
Patient.RFA Length	RFA_Length	Right Forearm Length
Patient.RFA Recomp Length	RFA_Recomp_Length	Right Forearm Recomputed Length
Patient.LFA Length	LFA_Length	Left Forearm Length
Patient.LFA Recomp Length	LFA_Recomp_Length	Left Forearm Recomputed Length
Patient.RFA Min BMD	RFA_Min_BMD	Right Forearm Minimum BMD
Patient.LFA Min BMD	LFA_Min_Bmd	Left Forearm Minimum BMD
Patient.Last Date Study Modified	Last_Date_Study_Modified	Last Date that Patient Record was Modified
Patient.DiCOM Accession Number	Accession_Number	DiCOM Accession Number

Patient Parameters (continued)

Displayed in Source List As:	Displayed in Exported File As:	Description
Patient.Number of Scans	Number Of Scans	Total Number of Scans for the Patient
Patient.Last Scan Acquire Date	Last Scan Acquire_Date	Last Scan Date for the Patient
Patient.Physician	Last_Physician	Patient's Physician at the Time of the Last Visit
Patient.ReferringPhysician	Last_Referring_Physician	Patient's Referring Physician at the Time of the Last Visit

Table 14-2: Visit Parameters

Displayed in Source List As:	Displayed in Exported File As:	Description
Visit.Study ID	Study_ID	Unique ID Number for the Visit Generated by the System Using the Patient ID and the Visit Date
Visit.Study Date	Study_Date	Date of the Visit
Visit.Medications	Medications	Patient Medications on the Date of the Visit
Visit.Study Physician	Study_Physician	Patient's Physician on the Date of the Visit
Visit.Referring Physician	Study_Referring_Physician	Patient's Referring Physician on the Date of the Visit
Visit.Height at Visit	Height_At_Visit	Patient's Height on the Date of the Visit
Visit.Weight at Visit	Weight_At_Visit	Patient's Weight on the Date of the Visit
Visit.Study Date Time	Study_Date_Time	Date and Time that the Visit was Created
Visit.Bone History	Bone_History	Bone History Entered on the Date of the Visit
Visit.Treatment	Treatment	Treatment Entered on the Date of the Visit
Visit.Comments	Comments	Comments Entered on the Date of the Visit
Visit.Billing Info	Billing_Info	Billing Information Entered on the Date of the Visit

Table 14-3: Scan Parameters

Displayed in Source List As:	Displayed in Exported File As:	Description
Scan.Scan ID	Scan_ID	Unique ID Number for the Scan Generated by the System Using the Patient ID, the Visit Date, and the Order that the Scan was Created.
Scan.Scan Date Time	Scan_Date_and_Time	Date and Time that the Scan was Performed
Scan.Technologist	Technologist	Technologist who Performed the Scan
Scan.Last Date Scan Modified	Last_Date_Scan_Modified	Date and Time that the Scan was Last Modified
Scan.Last Modified By	Last_Modified_By	Technologist who Performed the Last Modification.
Scan.Scan Type	Scan_Type	<p><i>Text Identifying the Scan Type:</i></p> <p>“Spine”=AP Spine scan “Lat Spine”=Lateral Spine scan “Left Hip”=Left Hip scan “Right Hip”=Right Hip scan “Body”=Original Whole Body scan “DF Body”=Whole Body with Dynamic Filtration scan “NDF Body”=Whole Body without Dynamic Filtration scan “L Forearm”=Left Forearm(COMAC) scan “R Forearm”=Right Forearm(COMAC) scan “L F Arm H”=Left Forearm(HA) scan “R F Arm H”=Right Forearm(HA) scan “S Spine”=Scoliotic AP Spine scan “Research”=Research scan “Sm Subject”=Small Subject scan COMAC denotes COMAC calibration HA denotes hydroxyapatite calibration</p>
Scan.Physician	Physician	Patient’s Physician on the Date of the Scan
Scan.Height at Scan	Height_At_Scan	Patient’s Height on the Date of the Scan
Scan.Weight at Scan	Weight_At_Scan	Patient’s Weight on the Date of the Scan

Scan Parameters (continued)

Displayed in Source List As:	Displayed in Exported File As:	Description
Scan.Scan Type ID	Scan_Type_ID	<p><i>Unique Number Identifying the Scan Type:</i></p> <p>"1"=AP Spine scan "2"=Left hip scan "3"=Right hip scan "4"=Body scan "5"=Research scan "6"=Small animal scan "7"=Lateral spine scan "8"=Left forearm - XR (COMAC) scan "9"=Right forearm - XR (COMAC) scan "10"=Dynamic filter body scan "11"=Non-dynamic filter body scan "14"=Left forearm - XR (HA) scan "15"=Right forearm - XR (HA) scan "22"=Scoliotic AP Spine scan</p>
Scan.WB Results(Available only when enable by scanner options)	Total % Fat Siri % Fat Brozek % Fat ST Fat % %TBMC/FFM	Results Specific to Whole Body Scans with Soft Tissue

Table 14-4: Region Parameters

<p>The following parameters are exported for each region. A scan may have up to ten regions exported. * x denotes the region number.</p>		
Displayed in Source List As:	Displayed in Exported File As:	Description
Region.Name	Region x Name*	<p><i>Text Identifying the Region Type:</i></p> <p>“vert L1”=AP Spine L1 Vertebra “vert L2”=AP Spine L2 Vertebra “vert L3”=AP Spine L3 Vertebra “vert L4”=AP Spine L4 Vertebra “lspn L2”=Lateral Spine L2 Vertebra “lspn L3”=Lateral Spine L3 Vertebra “lspn L4”=Lateral Spine L4 Vertebra “fem neck”=Hip Femoral Neck “troch”=Hip Trochanter “wards tri”=Hip Wards Area “fem shaft”=Hip Femoral Shaft “distal”=Distal R+U Forearm site “proximal”=Proximal R+U Forearm site “d radius”=Distal Radius Forearm site “p radius”=Proximal Radius Forearm site Original Body scan “head”=Head “trunk”=Trunk “pelvis”=Pelvis “legs”=Legs “right arm”=Right Arm “left arm”=Left Arm “total”=Total “chest”=Chest “abdomen”= Abdomen Revision 2.4 and Later Body scan “head N”=Head “chest N”=Chest “midriff N”=Midsection “pelvis N”=Pelvis “l leg N”=Left Leg “r leg N”=Right Leg “l arm N”=Left Arm “r arm N”=Right Arm “Hip TsBMD”=Total Hip sBMD “APL14sBMD”= AP Spine L1-L4 sBMD “APL24sBMD”=AP Spine L2-L4 sBMD</p>

Region Parameters (continued)

The following parameters are exported for each region. A scan may have up to ten regions exported. * x denotes the region number.		
Displayed in Source List As:	Displayed in Exported File As:	Description
Region.Type	Region x Type*	<p><i>Unique Number Identifying the Region Type:</i></p> <p>“1”=AP Spine L2 Vertebra “2”=AP Spine L3 Vertebra “3”=AP Spine L4 Vertebra “4”=Hip Femoral Neck “5”=Hip Trochanter “6”=Hip Wards Area Original Body scan: » “7”=Head » “8”=Trunk » “9”=Pelvis » “10”=Legs » “11”=Right Arm » “12”=Left Arm » “13”=Total » “15”=Chest » “16”= Abdomen</p> <p>“17”=Lateral Spine L3 Vertebra “18”=Lateral Spine L4 Vertebra “19”=Lateral Spine L2 Vertebra “20”=Distal R+U Forearm site “21”=Proximal R+U Forearm site “22”=Distal Radius Forearm site “23”=Proximal Radius Forearm site Revision 2.4 and Later Body scan: » “24”=Head » “25”=Chest » “26”=Midsection » “27”=Pelvis » “28”=Left Leg » “29”=Right Leg » “30”=Left Arm » “31”=Right Arm</p> <p>“32”=Hip Femoral Shaft “34”=Total Hip sBMD “35”=AP Spine L2-L4 sBMD “37”=AP Spine L1 Vertebra “38”= AP Spine L1-L4 sBMD</p>
Region.BMC	Region x BMC*	Bone Mineral Content (g)
Region.Area	Region x Area*	Bone Area (cm ²)
Region.BMD	Region x BMD*	Bone Mineral Density (g/ cm ²)
Region.SoftTissue	Region x SoftTissue*	Soft Tissue (g)

Region Parameters (continued)

The following parameters are exported for each region. A scan may have up to ten regions exported.

* x denotes the region number.

Displayed in Source List As:	Displayed in Exported File As:	Description
Region.FatMass	Region x FatMass*	Fat (g)
Region.LeanMass	Region x LeanMass*	Lean Tissue (g)
Region.T Score	Region x T Score*	T-score
Region.Z Score	Region x Z Score*	Z-score

This page intentionally left blank.

CHAPTER 15

General Maintenance

Daily calibrations will verify proper operation of the x-ray source and detector assembly, as well as any moving parts. If the system fails to operate properly for any reason, contact the local Norland Technical Support representative.

No part of the Norland system is suitable for repair by the operator. Only Norland trained personnel have access to Norland certified components. Other manufacturer's components are not compatible with Norland systems. Norland will make available service documentation upon request to those qualified technicians who have received Norland service training.

Neither the x-ray source nor the laser positioning aid requires any maintenance or adjustment by the operator.

Faithfully performing the procedures in this section and manual will minimize the risk of losing patient data, and help insure trouble free operation.

This chapter discusses the following.

Routine Maintenance	15-2
Quick Reference Guide - System Backup with EaseUS Todo Backup	15-3
Quick Reference Guide - System Backup for Windows 7	15-4
System Maintenance	15-5
Corrective Procedures	15-5

Routine Maintenance

Detailed routine maintenance procedures are documented next.

Cleaning Scanner Exterior

The scanner exterior should be cleaned with a soft towel moistened (but not soaked) with standard antiseptic cleaning solution. The scanner should be cleaned as part of the daily cleanup associated with most facilities.



Note: Cleaning solutions must not be sprayed directly onto the scanner - to avoid possible damage to interior electronic components.

Cleaning Table Top Pad

The pad is made of an antimicrobial material, which inhibits the growth of microorganisms. The pad is secured by Velcro strips.

The pad can be cleaned with a damp cloth or a mild cleaner such as Windex®. Other cleaners may be too abrasive. Do not use any product containing bleach.



Note: If the Table Top pad is removed for cleaning, make sure it is re-installed in the same orientation - patient head rest to the right.

Cleaning Positioning Aids

Clean the **vinyl coated** positioning aids by wiping them with a standard antiseptic cleaning solution.

Clean the **fabric covered** leg block with a damp cloth or by removing the cover and dry cleaning.

Cleaning QC Phantom

Clean the QC Phantom with water and a soft cloth.



Caution: DO NOT USE ALCOHOL TO CLEAN THE QC PHANTOM.

Preventative Maintenance Schedule

Norland recommends annual preventative maintenance, performed by Norland trained technicians.

Quick Reference Guide - System Backup with EaseUS Todo Backup

Norland recommends that system backups be performed regularly for the patient scan data and calibration data. Two USB flash drives are supplied from Norland.

All computers supplied by Norland are set up to automatically perform a backup of the IlluminatusDXA software and data on a daily schedule. The computer must be turned on, and a USB flash drive must be connected to the computer for the backup to complete successfully on schedule. The automated backup requires no user intervention if the backup drive is available and the schedule is allowed to run.



Note: This procedure applies to using the EaseUS Todo Backup v9.x program. This process does not apply to any other versions of Windows. To configure the backup, refer to "Configuring Backup for Windows 10" on page 3-6.

TO BEGIN THE SYSTEM BACK-UP MANUALLY:

- » Exit the Illuminatus software to the Windows desktop.
- » Insert the USB flash drive into one of the USB ports.
- » Run the EaseUS Todo Backup program.
- » Next to the Norland Backup job, click Backup. Select Full Backup to begin.

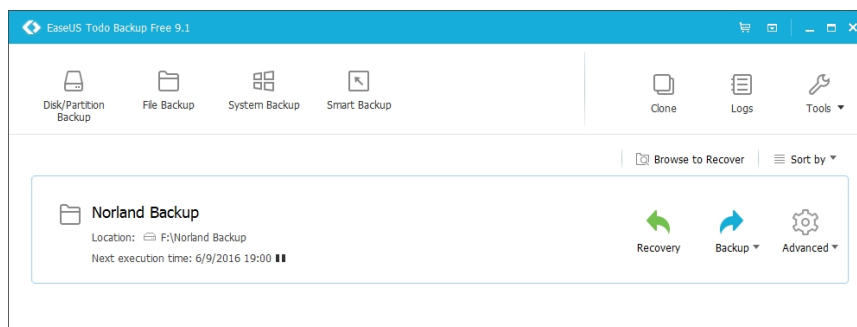

- » The backup progress will be displayed while the backup is being performed.

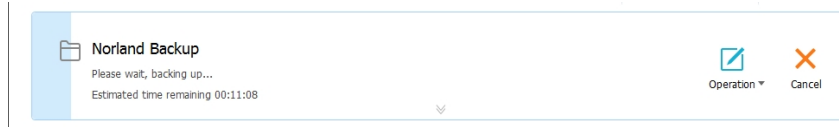

- » When the backup is complete, the "Last Backup" date and time will be updated and the progress bar will disappear.
- » The USB drive should remain plugged into the computer for the backup to run automatically on schedule. If the drive must be removed, select "Safely Remove Hardware and Eject Media" from the Windows system tray. Click on "Eject Mass Storage" for the flash drive. Wait until the "Safe to Remove Hardware" message is displayed. Remove the flash drive from the USB port and store in a safe place.

Quick Reference Guide - System Backup for Windows 7

Norland recommends that system backups be performed periodically for the patient scan data and calibration data. Two USB flash drives are supplied from Norland.

All computers supplied by Norland are set up to automatically perform a backup of the IlluminatusDXA software and data on a weekly schedule. The computer must be turned on, and a USB flash drive must be connected to the computer for the backup to complete successfully on schedule. The automated backup requires no user intervention if the backup drive is available and the schedule is allowed to run.



Note: This procedure applies to using the Backup and Restore program included in Windows 7. This process does not apply to any other versions of Windows. To configure the backup, refer to "Configuring Backup for Windows 7" on page 3-7.

TO BEGIN THE SYSTEM BACK-UP MANUALLY:

- » Exit the Illuminatus software to the Windows desktop.
- » Insert the USB flash drive into one of the USB ports.
- » Click the Start menu, All Programs, Maintenance, and select Backup and Restore.
- » Click the "Backup up now" button.

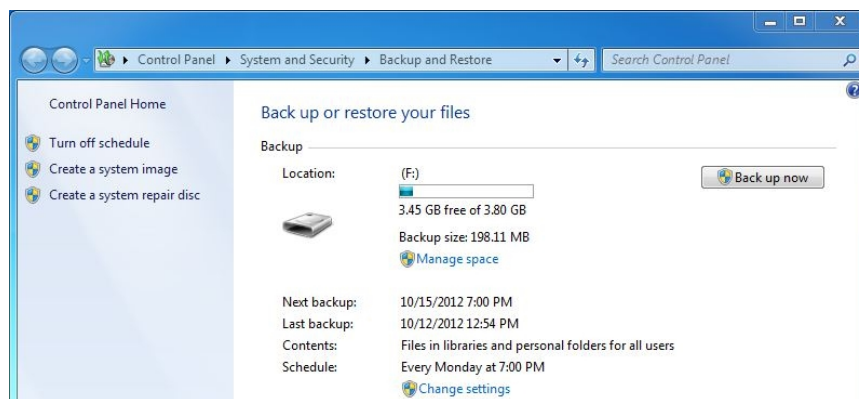

- » The backup progress will be displayed while the backup is being performed.

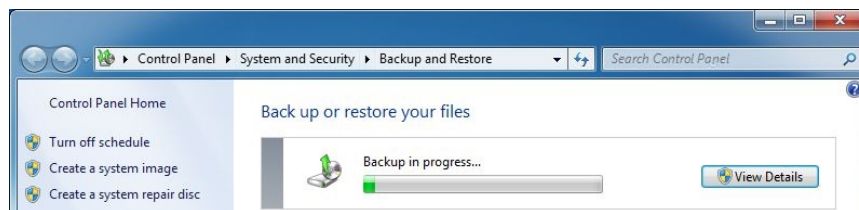

- » When the backup is complete, the "Last Backup" date and time will be updated and the progress bar will disappear.
- » The USB drive should remain plugged into the computer for the backup to run automatically on schedule. If the drive must be removed, select "Safely Remove Hardware and Eject Media" from the Windows system tray. Click on "Eject Mass Storage" for the flash drive. Wait until the "Safe to Remove Hardware" message is displayed. Remove the flash drive from the USB port and store in a safe place.

System Maintenance

Computer Maintenance

The accompanying OEM documentation will provide maintenance information for the computer.

Printer Maintenance

The accompanying OEM documentation will provide maintenance information for the printer.

Corrective Procedures

Operational problems are usually identified by warning messages as the situation occurs. Most of the messages prescribe the necessary action. Other problems can usually be resolved by shutting down and restarting. Whenever further repairs are needed, contact the local Norland Technical Support number.

Performing Multiple QC Phantom Scans

Scans of the QC Phantom can be performed independently of the Daily Calibration Procedure outlined in Chapter 4 - Basic Operation or the Quick Reference Guides. Performing this procedure is typically done under the direction of a Norland Technical Support Representative.

1. From the main Database Navigator window, click on **Calibration > QC Scan** to open the QC Scan tab window.

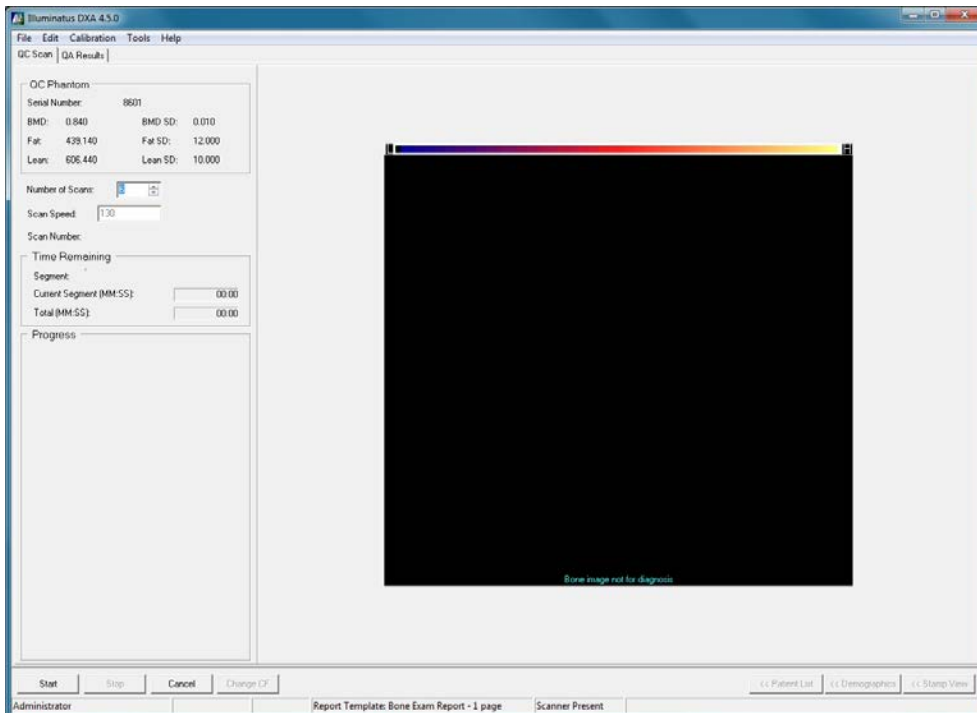

Caution: The Scanner Arm will move during the next step. STAY CLEAR OF THE SCANNER ARM.

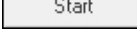
2. Type in the *Number of Scans* to be performed (6 is used in this example) and click .
3. Turn on the laser.

 **Caution:** Do not stare into the beam.

4. Place the black QC Phantom on the scanner table in the marked location. The “C” on the box should be oriented to the right side of the table (operator facing the table). Position the Phantom parallel to the back rest.

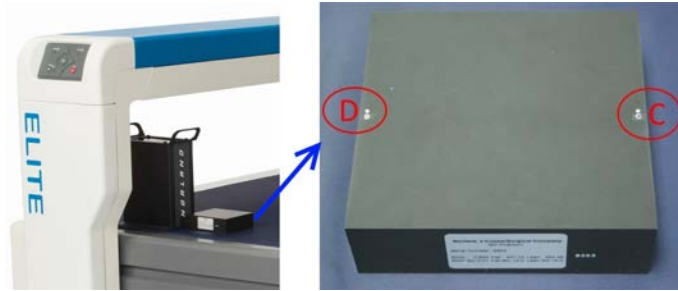

Marking the QC Phantom

1. Use the arrow buttons to move the scanner arm so that the laser positioning dot is on the dot marked C on the QC Phantom (see figure below).



2. Verify the Phantom is straight by using the arrow buttons to move the laser to the dot marked D. Re-position the Phantom if it is not straight. Move the laser back to the dot marked C.
3. Press  to mark point C.
4. As soon as the Phantom is positioned and marked, an Alert dialog box pops up. Wait while the source ramps up. The dialog box will automatically close when the X-ray source is ready.
5. The scan will begin automatically. The window will display the scan image as it develops and update the status of the scan.
6. At completion, an audible indicator will sound, indicating that the shutter has closed and the x-ray beam is no longer present. The results will be displayed in the QA Results tab window.

CHAPTER 16

Troubleshooting

Most operational difficulties can be easily rectified through the use of installed software utilities or through established troubleshooting procedures. During operation, occasionally minor warning messages will display to notify operator of current condition or status. Sometimes these messages will be accompanied by a suggested action. This section will assist in overcoming those not so obvious situations.

This chapter discusses the following.

Startup	16-2
Scanner Operation	16-3
Software Operation	16-4
Calibration	16-6
Printer	16-7
Reference/Trend Chart Display	16-8
Height and Weight on Reports	16-9
FolderMAIL	16-9

Startup

Startup Faults

Table 16-1: Startup Faults

Condition	Action
No Communication (Database Navigator window displays "Scanner not Present")	<ul style="list-style-type: none"> » Turn off power to the scanner and ensure that the cable from the computer to the scanner is secure. Retry. » Verify there is power to the scanner. » Scanner arm should not move freely when pushed, and the source fan should be audible. » Turn off the scanner and computer, wait 10 seconds, turn them back on.
No power to the scanner	<ul style="list-style-type: none"> » If the scanner is plugged into the power strip, verify the power strip is turned on and the light is on. » Verify there is power to the outlet. » Verify the Emergency Stop button has not been activated. Twist the button to release it, then turn the power switch off and on again to reset the scanner. » Verify correct voltage is selected at the power entry module.

Software Installation Faults

If the Setup window does not open during installation, click on **Start**, then **Run**. Click , browse to the CD drive, click on **setup.exe**, and click .

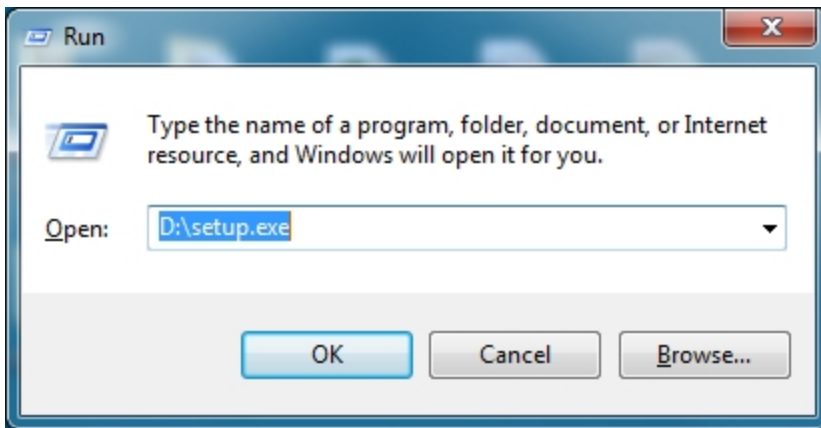

Continue with "Software Installation Instructions" on page 3-2.

Scanner Operation

Table 16-2: Scanner Faults

Condition	Action
Scanner arm motion erratic	<p>Verify nothing is blocking the arm movement. It may be necessary to remove the table top and check for obstructions.</p> <p>Clean the dust off the back rail using a clean cloth. Oil the rail with a light machine oil (such as 3-in-1 Oil). Do <u>not</u> use lubricants with a solvent or degreaser (i.e. WD40) or it may ruin the bearings.</p>
Scanner arm is not moving	<p>Manually push the scanner arm. If it moves freely there is no power to the scanner motors. Verify the scanner is plugged into a live outlet.</p> <p>Turn the scanner and computer off, wait 10 seconds, turn them back on, and retry.</p> <p>In the Database Navigator window, select Tools > Initialize Scanner to see if the arm will move to home position.</p> <p>Turn the scanner off. While holding down the left and right arrow keys on the scanner arm touch pad, turn the scanner back on, hold the arrow keys for approximately 1 second then release. Verify that the scanner arm will now move under the control of the arrow buttons.</p> <p>If still unsuccessful, contact Technical Support.</p>
Will not find origin	<p>Verify that nothing is blocking the arm from moving to the extent of the left travel.</p> <p>Verify that nothing is blocking the source from moving to the back.</p> <p>Verify that the limit switches are properly activated.</p>

Software Operation

If error messages similar to the image below appear, print the errors or write them down, and contact Technical Support with the details of the message.

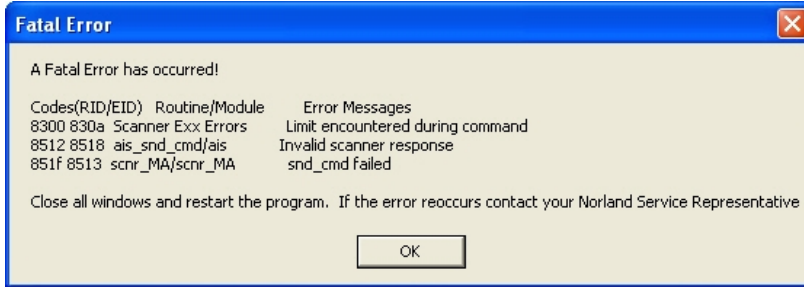

Table 16-3: Software Faults

Condition	Action
Fatal Error: Limit encountered during command OR Limit encountered prior to command	The scanner table has reach the limits at the end of the table before it expected to. Click OK to close the error window. Turn off the scanner power, and push the scanner arm toward the middle of the scanner. Turn the scanner power back on. Return to the Patient Visit List screen. Click Tools > Initialize Scanner to reinitialize the scanner.
“Application already running” message when starting IlluminatusDXA program	Check in the Windows task bar to see if the IlluminatusDXA software is already running, and select it to activate the program that is already open. Only one instance of the program may be running at a time. If another instance of the program is not currently running, click Yes to restart the IlluminatusDXA program.
Time/date display incorrect	Right-click on the time in the lower right corner of the Windows desktop. Click on Adjust Date/Time . Adjust as necessary.
Patient scanned under wrong name, or same patient has two records and need to be merged	Contact Technical Support.
Scan View button not active	Verify that the message “Scanner Present” is displayed at the bottom of the Database Navigator window in the Norland Illuminatus software. If not, refer to the troubleshooting condition “No Communication” in the “Startup Faults” on page 1.
When you select Report and a blank screen appears	Click Close to close the report screen. Click on Select Template to select the appropriate report template. Click Report to generate a new report.
Displays “Scanner Sub-system is busy” when trying to exit Illuminatus.	Return to the Patient List before exiting.

Software Faults (continued)

Condition	Action
Table Top Values Out of Range - when performing Whole Body scan	When performing a Whole Body scan, if the patient is marked improperly, the software may not be able to locate the top of the patient's head for the beginning of the scan. Refer to the chapter "Scanning Whole Body" on page 1 for instructions on performing the Whole Body scan.
Failed or partially failed to import data. See runtime log.	When performing a Database Import from GEM files, one or more patients were not successfully imported. Verify the import source directory contains all necessary data files and patient directories. Perform XFCHECK on the data from the GEM computer to verify the data is free of errors.
Error: The selected directory is not a database.	This message may appear when performing File > Database > Active Database > Add to List . If the selected folder contains subfolders named PAT00001, PAT00002, etc., use the File > Database > Import option to import and convert GEM based scans to the Illuminatus database. Refer to "Importing a Database" on page 1.
Submit SQL Exception errors appear	This may indicate data corruption in the patient database file. Contact Norland Technical Support for assistance.

Calibration

Table 16-4: Calibration Faults

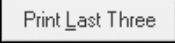
Condition	Action
Alert: Calibration points were taken in the wrong order.	When marking the points on the calibration standard, the points were marked in the wrong order, or were not marked in the proper location on the calibration standard. See "Daily Calibration Procedure" on page 4-6 for instructions on performing the calibration.
Alert: Process timed out before enough counts were collected. The x-ray source is not generating enough x-rays or the beam is blocked.	This error may appear if there is a power problem inside the scanner, or if the x-ray source has failed. Contact Technical Support for assistance.
Calibration Diagnostics: Fail <ul style="list-style-type: none"> » Autoset PMT Gains » Reference Beam » X-ray Off » Shutter » Low Atten. Filter » Med. Atten. Filter » High Atten. Filter » Dynamic Filtration 	Verify the calibration standard is placed in the correct calibration area. Verify points 'A' and 'B' were marked in the correct order and on the 'X' in the Plexiglas of the calibration standard. Turn off the scanner and computer and repeat the calibration. If the calibration fails a second time, print the errors and contact Technical Support. TO PRINT: Go to Tools > Calibration Details > diagnost.trc tab. Then click on  .
Calibration Status: Failed	Verify the calibration standard (QA Phantom) is placed in the correct calibration area. Verify points 'A' and 'B' were marked in the correct order and on the 'X' in the Plexiglas of the calibration standard. Verify the Calibration Standard has not been dropped and broken. Turn off the scanner and computer and turn back on. Repeat the calibration. If the calibration fails a second time follow the instructions below to print the errors and contact Technical Support. TO PRINT: Go to Tools > Calibration Details > errors.trc tab. Then click on  .

Calibration Faults (continued)

Condition	Action
Precision or Accuracy: Out of Range	<p>Verify the QC (spine) phantom was placed on the table in the scan area, and the phantom was marked appropriately. See "Position the Standard and the Phantom on the Scanner" on page 4-7.</p> <p>Verify the phantom was not moved after it was marked.</p> <p>Verify the phantom is not broken or cracked.</p> <p>If the last QC Scan taken during calibration is an invalid measurement due to operator error, contact Technical Support for assistance in deleting the invalid scan. Technical Support will advise:</p> <p>Go to Tools > File Tools and click the QC tab. Click on the appropriate record and then click on . Repeat QC Scans, and verify that Precision and Accuracy are OK.</p>
Beam Stability Quality Failure	<p>This failure may occur during the calibration process while scanning the calibration standard. Power off the scanner table for one minute, then power on the scanner and retry the calibration.</p> <p>If the problem occurs again, contact Technical Support.</p>

Printer

Table 16-5: Printer Faults

Condition	Action
Printer excessively loud	<p>Check to ensure the printer cartridges are latched in place by lifting the printer cover and verifying both cartridges are secure in their respective holders.</p> <p>If necessary apply silicone lubricant on the printer drive rod to reduce noise and friction.</p>
Text missing from the printed report	<p>Replace the printer cartridges. Replace them with the same model number as on the print cartridge. Install them in the correct holder.</p>
Lines through the text or image	<p>Use a cotton swab to clean both sides of metal bar under cartridges.</p> <p>Replace printer cartridge (refer to printer manual for details).</p>
Will not print, large print type, or random letters	<p>Reset printer.</p> <p>If problem persists, empty print queue.</p>
Only printing one page or report appears different	<p>Verify the correct report template is displayed at the bottom of the screen. If it is not the correct report, click on Select Template and select the appropriate template.</p>

Reference/Trend Chart Display

Table 16-6: Reference/Trend Charts

Condition	Action
No trend chart displays (AP Spine scans)	Verify both/all scans are analyzed with the same options, such as Standard vs. Angulated, or L1-L4 vs. L2-L4.
No trend chart displays (all scan types)	Only one scan exists for the patient or trend option not selected.
No color bars appear on the graph	The selected Reference Set does not contain factory-defined color bars.
Reference Graphs appear in grayscale.	Right click on the large image in the filmstrip view and verify "Color" is selected from the options menu. Verify the "Always Display Reference Graphs in Color?" box is checked on the Edit >Advanced Preferences screen.
Reference Sets are installed but are not plotted	Patient does not have a birthdate entered in the Patient Demographics window, or it is the default birthdate (1/1/1900). Patient gender does not match that of the installed data sets or it has not been selected for the patient in the Patient Demographics window. There is no Reference Set available for the specific regions being graphed. There is no matching Ethnic group for the specific regions being graphed or it has not been entered in the Patient Demographics window. The Reference Set is disabled. Enable the Reference Set using the File > Reference Sets command. In Scan View, right-click on image. Go to <u>Graphs</u> and verify <u>Reference</u> is selected.
Reference Sets are incorrect	The wrong Reference Set was selected. Ensure that the correct ethnic information is entered in the Patient Demographics window.
The percent change or % change/year values do not appear or appears as '*****'	The current scan has the same date as the scan it is being compared to. Inadvertent copying of two or more identical patient scans may cause this. Compare the identical scans and delete all but one of them. The current scan is the first scan being graphed. A later scan in the series must be selected to obtain % change values. The calculated value requires more than five digits.
Percent Young value does not appear or appears as '*****'	A Young Ref(ERENCE) value has not been included in the reference set. Enter the Young Ref(ERENCE) value. The current Results mode is not Reference. Select the Reference mode. The calculated value requires more than five digits.

Reference/Trend Charts (continued)

Condition	Action
Percent Age-Matched value does not appear or appears as '*****'	The patient value is younger or older than the age range included in the selected Reference Set. The current Results mode is not Reference. Select the Reference mode. The calculated value requires more than five digits.
The Z-Score value does not appear or appears as '*****'	The patient age is younger or older than the age range included in the selected Reference Set. The current Results mode is not Reference. Select the Reference mode. The calculated value requires more than five digits. The Reference Set does not contain information for a full age range.

Height and Weight on Reports

Table 16-7: Height and Weight

Condition	Action
Height or Weight is incorrect on reports	Refer to "Changing Height or Weight on the Report" on page 11-62.

FolderMAIL

Table 16-8: FolderMAIL

Condition	Action
FolderMAIL is not active	Verify the logged-in user has a valid e-mail address entered in the location: Edit > User Preferences > Main Settings tab > E-Mail Address box (see page 3-20) The SMTP or MAPI has not been correctly configured: Edit > Advanced Preferences > Network tab (see page 3-43) An E-mail directory is not entered in: Advanced Preferences > Directory tab (see page 3-42)

This page intentionally left blank.

CHAPTER 17

Technical Reference

System specifications and required regulatory information can be found in this chapter. The labels are also included in this chapter.

This chapter discusses the following.

Norland Bone Densitometer System Specifications	17-2
Technical Description	17-4
Cautions	17-13
Label Locations	17-17
Scanner Labels	17-19
Controller Certification Label	17-22
Power Entry Module Labels	17-22
Tube Housing and High Voltage Generator Labels	17-22

Norland Bone Densitometer System Specifications

DXA System Description

Electrical Requirements

Mains Supply	100-120V \sim ; 220/230/240V \sim ; (\pm 10%) 50/60 Hz, 700 VA maximum
Mains Impedance	< 0.18 ohms

Environmental

Operating:

Temperature	60° - 90° F (15° - 32° C)
Relative Humidity	Up to 80% non-condensing

Transportation and Storage:

Temperature	-40° to 150° F (-40° to 65° C)
Relative Humidity	Up to 80% non-condensing
Altitude	Unlimited

X-Ray Detector Assembly

2 NaI Scintillation Crystals

Pulse Counting

Scanner Arm Drive

Stepper motors

Kevlar reinforced drive belts

x-y axis positioning

Laser

Type:	Laser diode
Class:	Class 2
Color:	Red (650 nm)
Power:	<1mW, continuous wave (CW)

Computer Description

Industry standard desktop (PC)¹

High capacity Backup device

Microsoft Windows

Antivirus

Printer

Computers used with CE Marked scanners must be marked for compliance with EMC standards (IEC 60601-1-2) and Information Technology Equipment standards (EN 60950) or equivalent.

IMPISO Power

The computer and its associated components must be powered from the Isolated Multiple Portable Socket Outlet (IMPISO) device if it was supplied with the scanner. This includes the processor, monitor, printer, and any external backup devices. The IMPISO must be plugged directly into the Mains supply (wall outlet). No other devices can be plugged into the IMPISO. Do not plug the scanner into the IMPISO. See the specific cautions for the IMPISO elsewhere in this Technical Reference Section of the Operator's Guide.

Expected Useful Life

With proper maintenance and servicing, this equipment can be expected to operate for at least five (5) years.

Operational Features

Calibrations	Automatic with supplied 77-step Calibration Standard and QC Phantom
Scan Sites ²	AP Spine Left or Right Hip Whole Body (optional) Lateral Spine (optional) Research (optional) Small Subject (optional)
Others	Soft Tissue Composition ³ Reference Data Sets ⁴

¹Computers used in the U.S. must be tested by Norland and certified to meet FDA performance standards as required by 21CFR1010.2.

²The AP Spine and Hip scans are available on all models. The other scan modalities are not available on all models.

³Not available on all models.

⁴Not available for all scan sites.

Performance

Scan Times

- <1.5 minutes AP Spine, high speed
- 1.5 minutes Hip, high speed
- <4.0 minutes Lateral Spine, high speed
- 5.0 minutes Whole Body

Dose Values

- <1.0 mRem (High Speed mode): Forearm, AP Spine, & Hip
- <0.1 mRem: Whole Body
- <3.5 mRem (High Speed mode): Lateral Spine

Spatial Resolution

AP Spine	Line Spacing - 1.5mm (1.0mm selectable) Point Resolution - 1.5mm (1.0mm selectable)
Hip	Line Spacing - 1.0mm Point Resolution - 1.0mm
Whole Body	Line Spacing - 13.0mm (9.0mm and 7.8mm selectable) Point Resolution - 6.5mm (4.5mm and 2.8mm selectable)
Lateral Spine	Line Spacing - 1.0mm Point Resolution - 1.0mm

Miscellaneous

Laser Marking

Positioning Aids

Hip Sling	Foot Separator Block
Leg Rest Block	Lateral Spine System (optional)

Dimensions

Tabletop

Length	Width	Height
94" (2388 mm)	56.5" (1435 mm)	32" (813 mm)

Overall

Length	Width	Height
120" (3048 mm)	78" (1981 mm)	60" (1524 mm)

Weight

775 lbs (352kg)

Table Weight Limit

625 lbs (283 kg)

Scanning Area

90" L by 52" W (2286 mm L by 1321 mm W)

Table to Scanner Arm Distance

17.5" (444 mm)

Technical Description

Significant Zone of Occupancy/Patient Environment

The operator should be at least three feet from the beam when the system is emitting x-rays. Refer to "Cautions" on page 17-13. If the operator stays at least three feet from the beam during the scan, the dose rate will be < 0.1 mRem/hr. For a one minute scan this is a 0.0017 mRem dose. For comparison, background radiation received per year is 150 mRems, and a cross-country round trip airline flight results in 5 mRems of additional exposure to the passengers and crew.

The computer should be located outside the perimeter of three feet from the beam and positioned such that the operator cannot touch the computer and the patient simultaneously. However, the computer can be closer if necessary as long as it is powered from the isolated multiple portable socket-outlet (IMPSO) device provided with the system.

Focal Spot to Image Receptor Distance (SID)

The SID is equal to 765mm. It is fixed and the operator does not adjust it.

X-ray Generator

- » Combination Tube Housing and High Voltage Generator
- » 100 kV ($\pm 2\%$) constant potential
- » 1.3 mA ($\pm 5\%$) constant current
- » Maximum heat dissipation = 300 W
- » Minimum filtration is 2.7mm Al. (1.9 irremovable + 0.8 fixed); Samarium k-edge @ 46.8 KeV
- » Focal Spot of x-ray tube = 0.5mm
- » Stationary anode with tungsten target
- » Power output of high voltage generator = 130 W
- » Air cooled and suitable for continuous operation

Classification

Class I - Type of protection against electrical shock.



Type B Applied Part (Patient Bed) - Degree of protection against electrical shock.

Continuous - Mode of operation (X-Ray Source).

IPX0 - Degree of protection against dust and water.



Laser product (used for selecting scan area)

Class II (FDA) per 21CFR1040

Cooling Curves & Tube Rating Charts

The operator is not required to make any decisions regarding patient scanning based on cooling curves & tube ratings. However, this information is available from your Norland Technical Support representative, if required.

Duty Cycle

No duty cycle limits apply. The system can be operated continuously without any degradation in performance as long as the ambient temperature and humidity specifications are not exceeded.

Technique (or Loading) Factors

X-ray tube voltage & current and scan time are the technique factors.

- » Tube voltage = 100 kV ($\pm 2\%$) constant potential. This is fixed and the operator does not adjust it.
- » Tube current = 1.3 mA ($\pm 5\%$) constant current. This is fixed and the operator does not adjust it.
- » Scan time depends on the scan type and area selected. Refer to the specifications.

Electrical Requirements

A hospital grade receptacle should be used to ensure safety ground continuity. No special voltage or current regulation or conditioning is required.

Installations



Warning: Connect only items that have been specified to be part of, or compatible with, this Medical Electrical (ME) system.

- » Unit should be installed in such a way that the operator can achieve optimum use of it.
- » Unit should be installed in such a way that the operator may disconnect the main power cord easily when required.
- » Minimum room size is 12 feet (365cm) by 10 feet (305cm)
- » No user installations. An authorized Norland service agent installs the device and trains the operator on proper use.



Caution: For patient and operator safety position the back of the scanner (open area under the tabletop) as close to the wall as possible to inhibit unauthorized access to the interior of the device.

- » Do not install near devices that produce large EMI fields (i.e. electro-cautery, elevator motors, etc.)
- » Do not install near other x-ray emitting or radioisotope devices.



Warning: Do not modify this equipment without authorization from the manufacturer.

Service

- » No user serviceable parts inside unit.
- » Norland will make technical servicing information available upon request to qualified technicians who receive Norland service training.
- » Only Norland trained personnel have access to Norland certified components.
- » Other manufacturer's components are not compatible with Norland systems.

FCC EMC Statement

Note: This equipment has been tested and found to comply with the limits for a Class B digital device pursuant to Part 15 of the FCC rules. These limits are designed to provide reasonable protection against harmful interference in a residential environment. This equipment generates, uses, and can radiate radio frequency energy and, if not installed and used in accordance with the instructions, may cause harmful interference to radio communication. However, there is no guarantee that interference will not occur in a particular installation. If this equipment does cause harmful interference to radio or television reception, which can be determined by turning the equipment off and on, the operator is encouraged to correct the interference by one or more of the following measures:

- » Reorient or relocate the receiving antenna.
- » Increase the separation between the equipment and the receiver.
- » Connect the equipment into an outlet that is on a circuit different from the receiver.
- » Consult the dealer or an experienced radio/TV technician for help.

IEC 60601-1-2 EMC Information

Medical electrical equipment requires special EMC precautions to be taken. This product must be installed and used in accordance with the EMC information included herein. It is possible that portable and/or mobile RF communications equipment could affect proper operation of this product. [Required per clause 6.8.2.201 a)].

The RS-232 cable received with this product must be used to connect the computer to the scanner to minimize the possibility of adverse EMC effects. Using a different cable could result in increased emissions and/or decreased immunity. [Required per clause 6.8.3.201 a) 1) & 2)].

Warning. Do not place other equipment on, or immediately adjacent to, the scanner or computer components of the Norland DXA bone densitometer. This could result in electromagnetic interference between the equipment. If this is unavoidable, carefully observe the Norland DXA bone densitometer (and the other equipment) to verify normal operation. [Required per clause 6.8.3.201 a) 4)].

Table 17-1: TABLE 201a

Guidance and Manufacturer's Declaration - Electromagnetic Emissions		
The Norland DXA bone densitometer is intended for use in the electromagnetic environment specified below. The customer or user of the Norland DXA bone densitometer should assure that it is used in such an environment.		
Emissions Test	Compliance	Electromagnetic Environment - Guidance
RF Emissions - CISPR 11	Group 1	The Norland DXA bone densitometer uses RF energy only for its internal function. Therefore its RF emissions are very low and are not likely to cause any interference in nearby electronic equipment.
RF Emissions - CISPR 11 Harmonic Emissions - IEC 61000-3-2 Voltage Fluctuations/Flicker Emissions - IEC 61000-3-3	Class B Class A Complies	The Norland DXA bone densitometer is suitable for use in all establishments, including domestic establishments and those directly connected to the public low-voltage power supply network that supplies buildings used for domestic purposes.

^aThis Table required per clause 6.8.3.201 a) 3)

Table 17-2: TABLE 202a

Guidance and Manufacturer's Declaration - Electromagnetic Immunity			
The Norland DXA bone densitometer is intended for use in the electromagnetic environment specified below. The customer or user of the Norland DXA bone densitometer should assure that it is used in such an environment.			
Immunity Test	IEC 60601 Test Level	Compliance Level	Electromagnetic Environment - Guidance
Electrostatic Discharge (ESD) IEC 61000-4-2	+/-6 kV contact +/-8 kV air	+/-6 kV contact +/-8 kV air	Floors should be wood, concrete, or ceramic tile. If floors are covered with synthetic material, the relative humidity should be at least 30%
Electrical Fast Transient/Burst IEC 61000-4-4	+/-2 kV for power supply lines +/-1 kV for input/output lines	+/-2 kV for power supply lines +/-1 kV for input/output lines	Mains power quality should be that of a typical commercial or hospital environment.
Surge IEC 61000-4-5	+/-1 kV differential mode +/-2 kV common mode	+/-1 kV differential mode +/-2 kV common mode	Mains power quality should be that of a typical commercial or hospital environment.
Voltage Dips, Short Interruptions, and voltage variations on power supply input lines IEC 61000-4-11	<5% Ut (>95% dip in Ut for 0.5 cycle) 40% Ut (60% dip in Ut for 5 cycles) 70% Ut (30% dip in Ut for 25 cycles) <5% Ut (>95% dip in Ut for 5 sec)	<5% Ut (>95% dip in Ut for 0.5 cycle) 40% Ut (60% dip in Ut for 5 cycles) 70% Ut (30% dip in Ut for 25 cycles) <5% Ut (>95% dip in Ut for 5 sec)	Mains power quality should be that of a typical commercial or hospital environment. If the user of the Norland DXA bone densitometer requires continued operation during power mains interruptions, it is recommended that the Norland DXA bone densitometer be powered from an uninterruptible power supply or a battery.
Power Frequency (50/60 Hz) Magnetic Field IEC61000-4-8	3 A/m	3 A/m	Power frequency magnetic fields should be at levels characteristic of a typical location in a typical commercial or hospital environment.
NOTE: Ut is the AC mains voltage prior to application of the test level.			

^aThis Table required per clause 6.8.3.201 a) 6)

Table 17-3: TABLE 204a

Guidance and Manufacturer's Declaration - Electromagnetic Immunity			
The Norland DXA bone densitometer is intended for use in the electromagnetic environment specified below. The customer or user of the Norland DXA bone densitometer should assure that it is used in such an environment.			
Immunity Test	IEC 60601 Test Level	Compliance Level	Electromagnetic Environment - Guidance
<p>Conducted RF IEC 61000-4-6</p> <p>Radiated RF IEC 61000-4-3</p>	<p>3 Vrms 150 kHz to 80 MHz</p> <p>3 V/m 80 MHz to 2.5 GHz</p>	<p>3 Vrms 150 kHz to 80 MHz</p> <p>3 V/m 80 MHz to 2.5 GHz</p>	<p>Portable and mobile RF communications equipment should be used no closer to any part of the Norland DXA bone densitometer, including cables, than the recommended separation distance calculated from the equation applicable to the frequency of the transmitter.</p> <p>Recommended separation distance:</p> <p>$d = 1.2 P^{1/2}$</p> <p>$d = 1.2 P^{1/2}$ 80 MHz to 800 MHz</p> <p>$d = 2.3 P^{1/2}$ 800 MHz to 2.5 GHz</p> <p>where P is the maximum output power rating of the transmitter in watts (W) according to the transmitter manufacturer, and d is the recommended separation distance in meters (m).</p> <p>Field strengths from fixed RF transmitters, as determined by an electromagnetic site survey, should be less than the compliance level in each frequency range.</p> <p>Interference may occur in the vicinity of equipment marked with the following symbol:</p> 
NOTE 1: At 80 MHz and 800 MHz, the higher frequency range applies.			
NOTE 2: These guidelines may not apply in all situations. Electromagnetic propagation is affected by absorption and reflection from structures, objects, and people.			
Field strengths from fixed transmitters such as base stations for radio (cellular/cordless) telephones and land mobile radios, amateur radio, AM and FM radio broadcast, and TV broadcast cannot be predicted theoretically with accuracy. To assess the electromagnetic environment due to fixed RF transmitters, an electromagnetic site survey should be considered. If the measured field strength in the location in which the Norland DXA bone densitometer is used exceeds the applicable RF compliance level above, the Norland DXA bone densitometer should be observed to verify normal operation. If abnormal performance is observed, additional measures may be necessary, such as re-orientating or relocating the Norland DXA bone densitometer.			
Over the frequency range 150 kHz to 80 MHz, field strengths should be less than 3 V/m.			

^aThis Table required per clause 6.8.3.201 b)

Table 17-4: TABLE 206a

Recommended Separation Distances Between Portable and Mobile Communications Equipment and the Norland DXA Bone Densitometer			
The Norland DXA bone densitometer is intended for use in an electromagnetic environment in which radiated RF disturbances are controlled. The customer or the user of the Norland DXA bone densitometer can help prevent electromagnetic interference by maintaining a minimum distance between portable and mobile RF communications equipment (transmitters) and the Norland DXA bone densitometer as recommended below, according to the maximum output power of the communications equipment.			
	Separation Distance According To Frequency Of Transmitter (m)		
Rated maximum power output of the transmitter (W)	150 kHz to 80 MHz $d = 1.2 P^{1/2}$	80 MHz to 800 MHz $d = 1.2 P^{1/2}$	800 MHz to 2.5 GHz $d = 2.3 P^{1/2}$
0.01	0.12	0.12	0.23
0.1	0.38	0.38	0.73
1	1.2	1.2	2.3
10	3.8	3.8	7.3
100	12	12	23
For transmitters rated at a maximum power not listed above, the recommended separation distance d in meters can be estimated using the equation applicable to the frequency of the transmitter, where P is the maximum output power rating of the transmitter in watts (W) according to the transmitter manufacturer.			
NOTE 1: At 80 MHz and 800 MHz, the separation distance for the upper frequency range applies.			
NOTE 2: These guidelines may not apply in all situations. Electromagnetic propagation is affected by absorption and reflection from structures, objects, and people.			

^aThis Table required per clause 6.8.3.201 b)

IEC 60601-1-6 Usability Information

Usability Characteristics

The Norland Bone Densitometers achieve a high level of usability, which allows the operator to quickly learn its operation and efficiently perform accurate bone density procedures. The following characteristics are particularly helpful in this respect:

- » Fixed Technique Factors - the x-ray tube voltage and current are not required to be set according to patient size or portion of the body being scanned. This eliminates this source of operator error.
- » Automatic (x-ray) Beam Intensity Adjustment - As the patient is being scanned, the intensity of the x-ray beam is monitored and adjusted to be optimal by switching filters in and out of the beam at high speed. This eliminates too low count rates that contribute to inaccuracies, and too high count rates that unnecessarily increase dose. This eliminates a potential source of operator error.
- » Automatic determination of Region Of Interest (ROI) - For virtually all scans, the software automatically locates the ROI and properly places the cursors, which determine the area to be analyzed. This quantitative approach is better and more consistent than what an operator can do. It contributes to better accuracy/precision, and reduces a potential source of operator error.
- » Hip Sling Positioner - This positioner takes the guesswork out of properly rotating the femur neck for the hip scan. It is easy to use and reduces the negative effect of not having the femur neck perpendicular to the x-ray beam.
- » Daily Calibration - The operator is prompted to do a calibration at the beginning of each day's scanning session. The calibration scans the Calibration Standard and QC Phantom, and automatically performs the analysis. The accuracy and precision results are displayed on a timeline, along with a pass/fail indication. This helps insure accurate and precise patient measurements.
- » Help Screens - A step-by-step procedure, complete with graphs and pictures, is on the screen while the operator is performing the scan. It is an easily understood, ready reference that helps preclude operator error.

Operator Profile

Norland Bone Densitometers are intended to be used by persons with the following skills/credentials:

- » Must be licensed in their State to operate x-ray medical devices. In most States, this means they must be a licensed Radiology Technologist, or hold a Limited License for Bone Densitometry. This law helps insure the operators are adequately educated regarding x-ray safety.
- » Participated in a Norland sponsored, device specific, training class, and passed the final test. This helps insure the operator knows how to achieve accurate/precise results with the bone densitometer.
- » Must have basic computer skills. This includes familiarity with the Windows operating system, keyboarding, mouse operation, how to print, how to backup files, and how to enter data into fields on the screen.

Fuse Information

Table 17-5: Fuse Ratings

Fuse Location	Fuse Rating
Power Tray F4 & F5	2A, 250V, 0.25" X 1.25" Slow Blow
Power Supply Board F1 & F2	2.5A, 250V, 0.25" X 1.25" Slow Blow
Source Control Board F1	10A, 250V, 0.25" X 1.25" Slow Blow
Power Tray F6 & F7 Power Supply Board F3	15A, 250V, 0.25" X 1.25" Slow Blow
Power Entry Module	10A, 250V, 0.25" X 1.25" Slow Blow 5A, 250V, 0.25" X 1.25" Slow Blow 6.3A, 250V, 5mm X 20mm, T 3.15A 250V, 5mm X 20mm, T

Beam Quality Information

Table 17-6: Beam Quality Information

Item	Equivalent Filtration ^a	Notes
Half Value Layer (HVL)	6.6mmAl	Tested at 100 kV & 1.3 mA.
Irremovable Materials	1.9mmAl	Tested with 70 kV, 2.5mmAL Source.
Added Filters	13.2mmAl	Tested with 70 kV, 2.5mmAl source. Minimum fixed filters is 0.003mm Sm.
Total Filtration	15.1mmAl	Sum of irremovable and added filters.
Patient Support Tabletop	0.3mmAl	Tested with 46.8kV, 5.5mmAl source.
Materials between patient & detector	0.2mmAl	Tested with 100 kV, 5.5mmAl source.

^aThese values are fixed. The operator does not select filtration

Position of X-ray Beam

The x-ray beam is located under the scanner arm. It may be located in any position under the arm. The exact location can be identified by activating the laser.

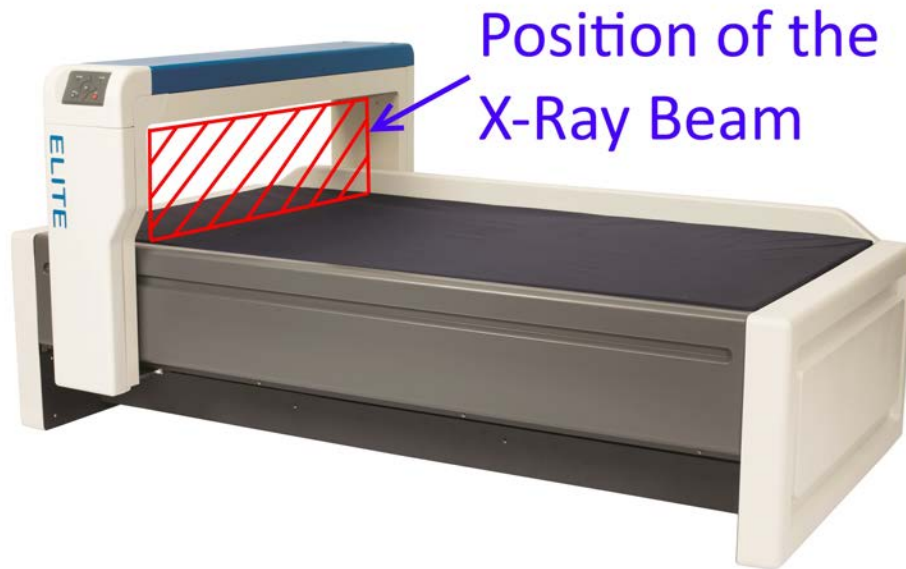

Figure 17-1: Possible X-ray Beam Location

Cautions

General Cautions



Caution: Do not touch the patient and the computer system, or other non-ME equipment parts, at the same time as this could increase leakage currents.



Caution: Device is not designed to be defibrillator proof.



Caution: Device is not intended for use in conjunction with flammable agents.



Caution: Device is not anesthesia proof.



Caution: Device is not intended for use in oxygen rich environments.



Caution: Not a patient connected device; patient equalization terminal not provided.



Caution: The laser within this product is not user serviceable. In the event it fails to operate, contact Norland Technical Support.



Caution: Use of controls or adjustments or performance of procedures other than those specified may result in hazardous radiation exposure.



Caution: Follow the procedures in the General Maintenance section of this manual to insure patient data is not lost.



Note: The device of which this x-ray source is a part is a Class I device, (per clause 5 of EN60601-1). However, this x-ray source is not designed, intended, or capable of operating as a stand-alone x-ray source.



Note: There are no user serviceable parts or user accessible fuses inside the unit.

Cautions for the Isolated Multiple Portable Socket-Outlet (IMPISO)



Caution: The IMPISO provided with this system is for use with the computer (computer, monitor, and printer). Properly used, it will reduce the risk of leakage currents for the patient and operator.



Caution: Do not connect the computer directly to a wall outlet instead of to the IMPISO because this would increase leakage currents.



Caution: The maximum load for the IMPISO provided with this ME system is 300 VA for 115/230 Vac at 50/60 Hz.



Warning: If another IMPISO is used, verify its electrical rating is adequate for the computer components plugged into it.



Caution: Do not connect any other equipment to the IMPISO as this could increase leakage currents.



Caution: Do not use additional IPMSOs, or extension cords, because they could increase leakage currents.



Caution: Do not place the IPMSO on the floor. Place it on a table or shelf to protect it from damage and spilled liquids, which could result in increased leakage currents.

Specific Cautions



and

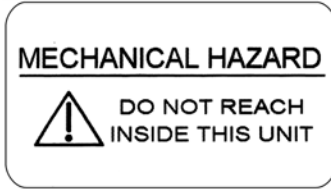

Warning: If you reach into the back of the unit, you could get your finger, hand or arm pinched between the scanner arm and scanner housing.

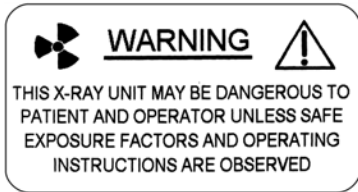

Warning: This device produces x-ray to achieve its intended purpose. It should only be used by qualified persons according to the instructions in this manual. Even though dose levels are very low, State and Federal regulations require scans of human subjects to be ordered by a physician.



100KV is generated inside the source. It is not accessible on the outside of the source or on the printed circuit board attached to the source.



A laser is used for marking the area of the patient to be scanned. Do not allow the beam to hit the patient's eyes and be careful that it does not reflect off shiny surfaces. The only operator control is on and off.

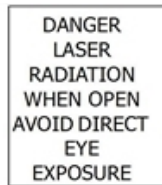

Caution: Use of controls or adjustments or performance of procedures other than those specified herein may result in hazardous laser light exposure.

Disassembling this part could result in exposure to laser radiation, Class II (FDA), Class 2 (CE). In particular, the laser module will continue to operate even if it is removed from its housing.



The laser beam will come through the long slot next to this label.



This unit is to be powered from a hospital grade receptacle to insure proper safety grounding.

Warning: To avoid risk of electric shock, this equipment must be connected to a supply with a protective earth.

Stray Radiation

Specified to be less than 0.1 mRem/hr at a distance of three feet from the beam.

This test was done while scanning a 20 x 30 x 15-cm water phantom. A Victoreen Model 450P Ion Chamber (300-cc) was used to measure the radiation levels at approximately one foot and three feet from the beam. The 450P had a current calibration from its manufacturer.

Top View

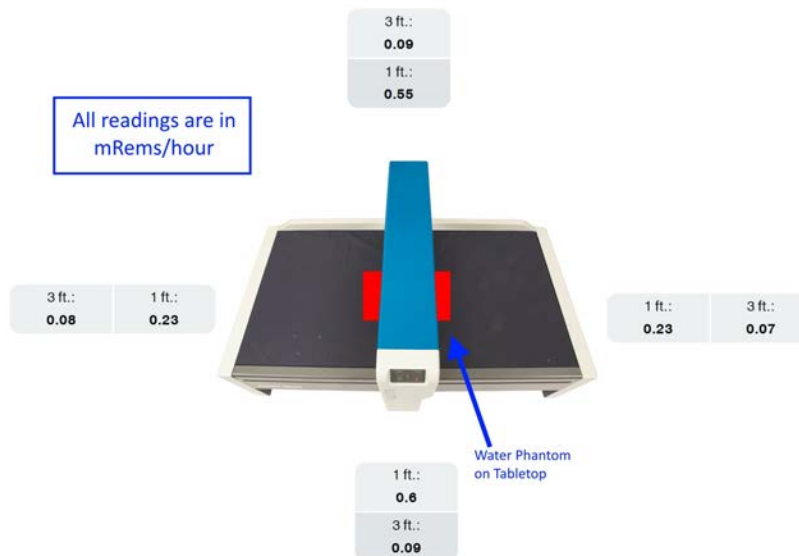

Front View

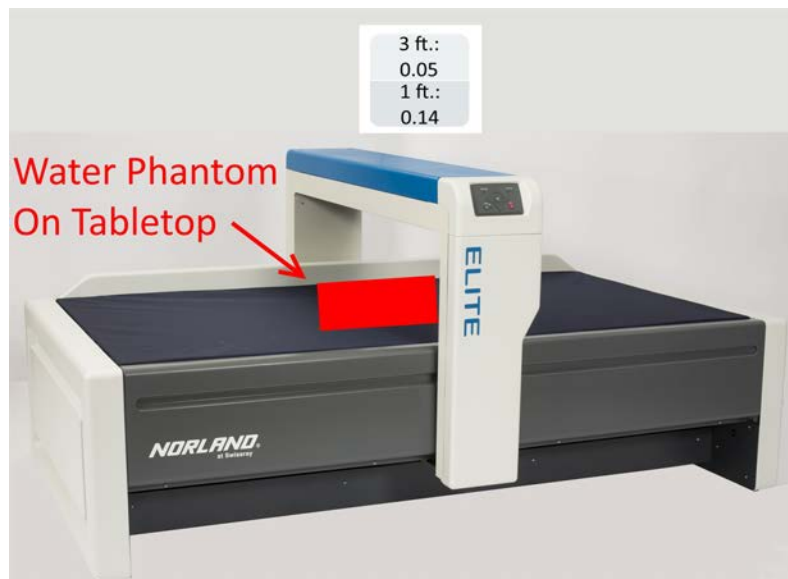

Label Locations

Scanner, Front View

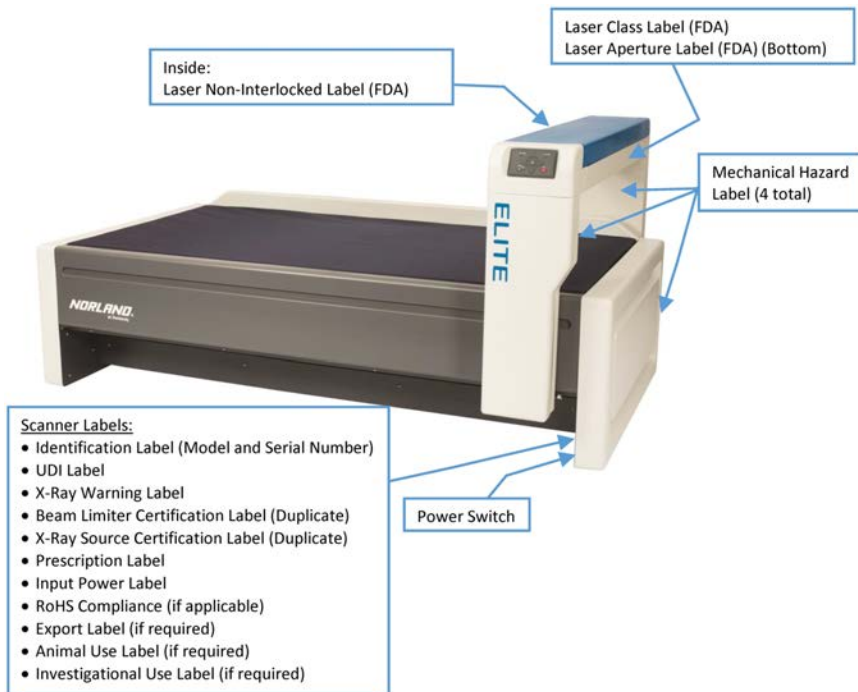

Scanner, Back View

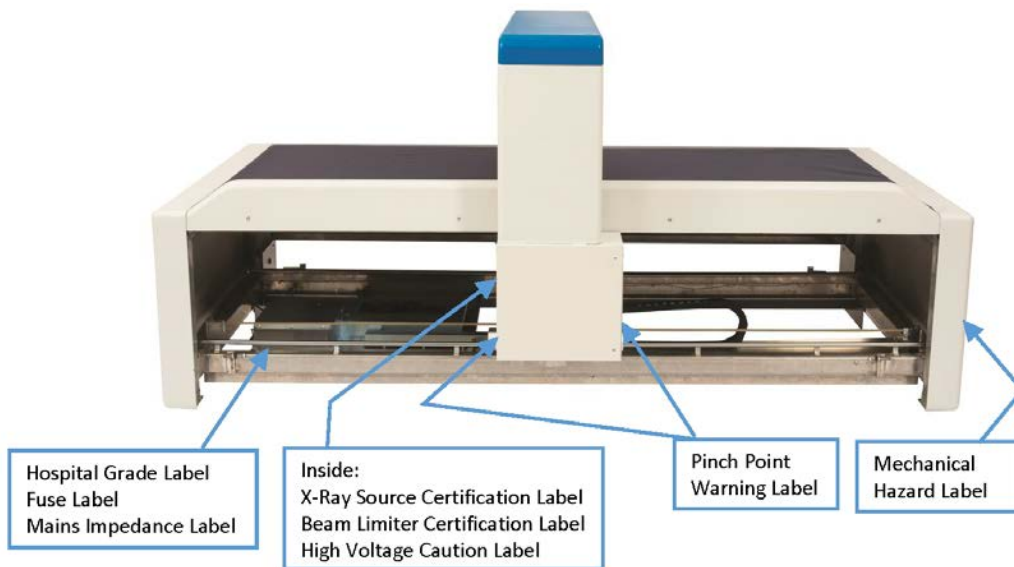

(Continued on the next page)

(Label Locations, continued)

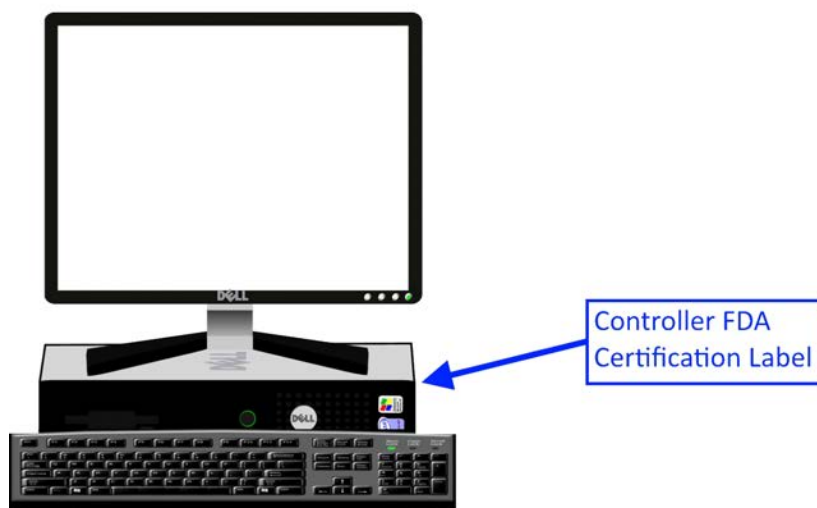

Scanner Labels

Identification Label

The scanner Model is designated by the name ELITE. The part number 437A150 is also on the label.

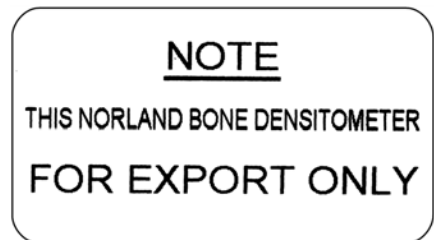
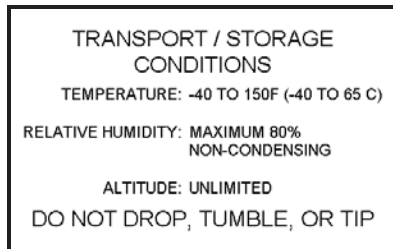
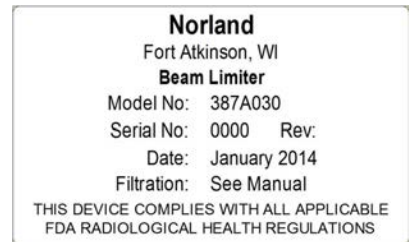
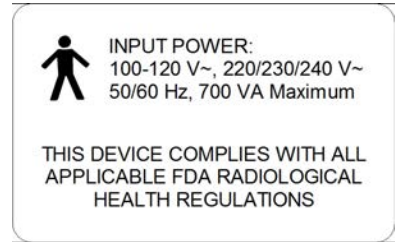
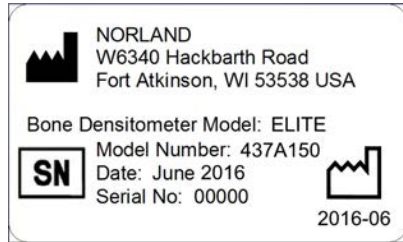

* Located on the outside of the shipping container.

* If applicable

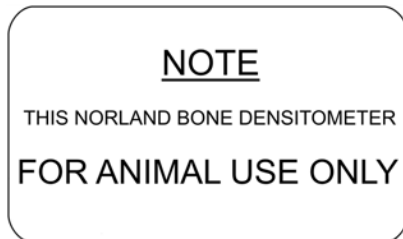

* If applicable

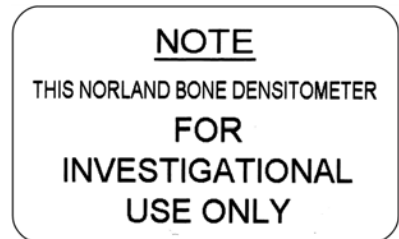



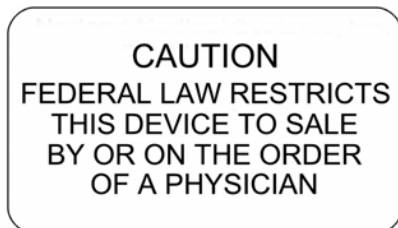

* If applicable



Follow Instructions for Use

(Scanner Labels, continued)

 **WARNING** 
THIS X-RAY UNIT MAY BE DANGEROUS TO
PATIENT AND OPERATOR UNLESS SAFE
EXPOSURE FACTORS AND OPERATING
INSTRUCTIONS ARE OBSERVED

 **AVERTISSEMENT** 
Cette unité de rayons X peut être
dangereuse pour le patient et
l'opérateur, à moins que des facteurs
d'exposition et des instructions de
fonctionnement sûrs ne soient observés.

 **CAUTION**
HIGH VOLTAGE
INSIDE

 **ATTENTION**
HAUTE TENSION
À L'INTÉRIEUR

MECHANICAL HAZARD
 DO NOT REACH
INSIDE THIS UNIT

RISQUE MÉCANIQUE
 NE PAS ENTRER
À L'INTÉRIEUR DE
CET APPAREIL

CAUTION
MAINS IMPEDANCE MUST
BE LESS THAN 0.18 OHMS

ATTENTION
L'IMPÉDANCE DU
RÉSEAU DOIT ÊTRE
INFÉRIEURE À 0,18 OHMS

LASER
APERTURE

OUVERTURE
LASER

(Scanner Labels, continued)

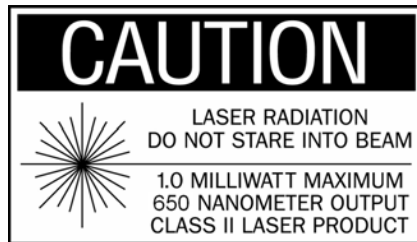
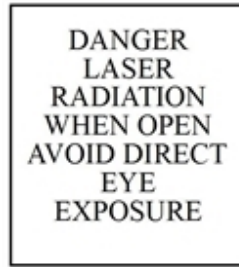

Controller Certification Label

The label below is affixed to the Norland Controller (the computer).

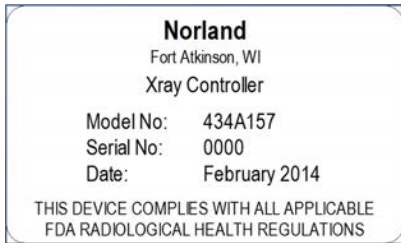

Power Entry Module Labels

The labels below are affixed to the Power Entry Module, located inside the scanner table.

LINE VOLTAGE	FUSE 1/4 X 1-1/4 250V	FUSE 5x20mm 250V
100 - 120 V~	10 A slow	6.3A (T)
220/230/240 V~	5 A slow	3.15A (T)
INPUT POWER: 700 VA MAX. 50/60 Hz		



Tube Housing and High Voltage Generator Labels

The label below is affixed to the Norland combination tube housing and high voltage generator (x-ray generator). A duplicate is also affixed to the scanner near the power switch.

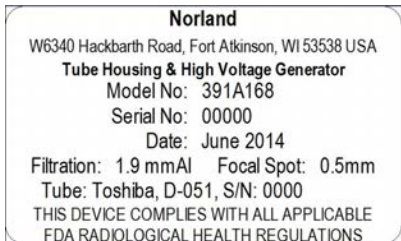

CHAPTER 18

Reference Data Sets

This chapter includes the Reference Set Data Sheets - Inclusion-Exclusion Criteria. It also includes the “Reference Set Data Sheets” for Central Bone Densitometers at the end of the chapter.

This chapter discusses the following.

Data Collection Sites	18-2
Data Gathering Process	18-2
Medical History Form Review Criteria	18-3
Excerpt from Calcified Tissue International	18-7
Excerpt from the Journal of Bone and Mineral Research	18-8
Norland Reference Data Set Values	18-10
NHANES III Reference Data Set Values	18-15

Data Collection Sites

For the Norland reference sets, the data was gathered at ten (10) study sites across the USA. The ages of the subjects scanned was from 20 to 89 years of age. All scan data was examined to verify acceptable quality (proper positioning, correct region placement, etc.). The numerical values for these subjects are listed in Table 1 in this document.

Data is provided for Female Caucasians for the Total Hip sBMD region as derived from phases 1 and 2 of the third National Health and Nutrition Examination Survey (NHANES III, 1988-1994). Reference values for this set are listed in Table 18-2 on page 18-15. The values were generated following the formula published in the Journal of Bone and Mineral Research (see page 18-8 of this chapter). The formula used is:

$$\text{sBMD} = 1000(1.012 * \text{BMD}_{\text{Norland}} + 0.026)$$

Data is also provided for Female Caucasians for the Spine L2-L4 sBMD region as derived from phases 1 and 2 of the third National Health and Nutrition Examination Survey (NHANES III, 1988-1994). The values were generated following the formula published in Calcified Tissue International (see page 18-7 of this chapter). The formula used is:

$$\text{sBMD} = 1000(1.0761 * \text{BMD}_{\text{Norland}})$$

Data Gathering Process

Information needed to determine appropriate classification into a particular sex and ethnic reference set was obtained from a self-reported detailed medical history required of all study participants. Information was noted on Medical History forms and verified by Norland selected investigators. Categories included height, weight, ancestry (ethnicity), occupation, diet, family history, medical and surgical history, and so forth. Ethnic individuals had to be at least 75% of the claimed ethnic background as self-reported.

Based on review of the medical history information, only data from normal, healthy, untreated individuals was included in each Reference Set. Individual participants having certain conditions and/or medication were included after consideration of each specific situation. Included individuals are grouped by gender, age, and ethnic background. Care was taken to include a significant amount of data from those in the younger age range, as well as a broad distribution of participants across all age ranges.

Data from those participants who reported illnesses or medication affecting the subject's bone health was excluded from the reference sets. Any of the diseases and conditions listed below (and on the Medical History form) were possible grounds for exclusion from the study. Data from participants with diagnosed osteoporosis [defined as those individuals who have x-ray evidence of vertebral fracture (including DXA scan), hip fracture associated with osteoporosis, loss of height, or other specified means] was not used in Norland reference sets.

Completed studies were examined by Norland QA to verify acceptable scan quality for inclusion in the reference set. Finally, subject information was reviewed by the clinical auditor to ensure that the complete clinical history met all the inclusion criteria.

Medical History Form Review Criteria

The Medical History form provided the information needed to determine whether a given individual should be included in the Normal Group or excluded in the Osteoporotic Group, or excluded from the study entirely. Since some medications significantly affect bone mass, interpretation was necessary to evaluate a particular drug's effect (based on dose, duration and time of life). Interpretation was also necessary to evaluate the effect of certain bone-active disorders. The following paragraphs provide guidance when evaluating the Medical Histories.

Osteoporosis

Data obtained from subjects diagnosed with osteoporosis was not used in Norland normative data but was saved for potential future, yet to be determined studies.

Other Bone-Active Diseases and Conditions

The diseases and conditions on the following page are listed in the Medical History form and provide possible grounds for exclusion from the study. Exclusion criteria was established to ensure the collection of bone density measurements from normal, healthy, untreated individuals.

Amenorrhic Syndrome: Exclusion only if syndrome was prolonged (at least 2 years), and recent (within the last three months).

Alcoholism: Exclusion only if severe, chronic, and accompanied by malnutrition. If possible, quantify amount of alcohol consumption.

Alzheimer's: Not grounds for exclusion.

Births: Number of births means number of pregnancies.

Broken/Fractured Hip: Not grounds for exclusion if occurred more than five years prior to data collection.

Cancer: Subject data may be included, as long as subject has been cancer free for more than five years. Localized squamous and basal cell are often not exclusions.

Cirrhosis: Exclusion only if clinically apparent and duration is greater than 3 months.

Cushing's Syndrome: Grounds for exclusion.

Diabetes: Exclusion only if onset occurred in childhood, delaying or retarding growth. Properly treated adult diabetics need not be excluded.

Early Menopause: Not grounds for exclusion. Early menopause is considered to be before 40 years of age. Make sure that the date of menopause is included for later analysis.

Emphysema: Exclusion if clinically apparent and/or severe COPD.

Fractures: Fractures due to accidents and trauma are not grounds for exclusion. Vertebral and other spontaneous fractures are grounds for exclusion.

Hyperparathyroidism: Data collected from these subjects will be excluded.

Hypoparathyroidism: Data collected from these subjects will be excluded.

Hyperthyroidism: If medication (dose) has been stable for 12 consecutive months, data need not be excluded.

Hypogonadism (Males): Grounds for exclusion.

Hypothyroidism: If medication (dose) has been stable for 12 consecutive months, data need not be excluded.

Hysterectomy: Hysterectomy with bilateral oophorectomy will be excluded.

Immobilization: Exclusion only if immobilization is prolonged for longer than one month, such as in stroke victims.

Leukemia: Grounds for exclusion.

Liver Disease: Exclusion only if clinically apparent and duration is greater than 3 months.

Lymphoma: Grounds for exclusion.

Malabsorption Syndromes: Grounds for exclusion.

Multiple Myeloma: Grounds for exclusion.

Paget's Disease: Data collected from these subjects will be excluded.

Renal Dialysis: Data collected from subjects on dialysis will be excluded.

Renal Disease: Renal disease without dialysis is not grounds for exclusion from the study. Subject is included if Creatinine is less than 2 and excluded if creatinine is more than 2. If Creatinine level is unknown, subject will be excluded.

Smoking: Not grounds for exclusion. However, please note current smoking habits and past smoking history, which includes amount and time frame.

Sickle Cell: Not grounds for exclusion.

Tuberculosis: Only grounds for exclusion if disease is active.

Vitamin Deficiencies: Not grounds for exclusion, but such deficiencies should be noted and explained.

Medications Affecting Bone

The use of medications affecting bone are possible grounds for exclusion. Such medications include:

Anticonvulsants: Grounds for exclusion.

Birth Control Pills: In general, birth control pills are not grounds for exclusion. Some postmenopausal subjects will report perimenopausal estrogen replacement therapy as "birth control pills" probably because of a comparison made by their physician. These subjects will not be excluded for estrogen use.

Bisphosphonates: Bisphosphonates are grounds for exclusion. Individuals currently using Bisphosphonates or those who have for less than six (6) months will be excluded. For those with a past history, please note medication, duration, dose and time frame on Medical History form.

Calcitonins: Calcitonins are grounds for exclusion. Individuals currently using Calcitonins or those who have ever used Calcitonins for more than six (6) months will be excluded. For those with a past history, please note medication, duration, dose and time frame on Medical History form.

Dilantin: Grounds for exclusion.

Estrogen: HRT and ERT are grounds for exclusion.



Note: Individuals currently on ERT or HRT: Those on ERT or HRT for less than three (3) months can be included in the study. Individuals who have been on HRT or ERT in the past: If it has been more than 24 months since treatment ended, the subject's data can be included in the study.

Heparin: Grounds for exclusion if taken for more than three (3) months.

Sodium Fluorides: Sodium Fluorides are grounds for exclusion. Individuals currently using Sodium Fluoride or those who have ever used Sodium Fluorides for more than six (6) months will be excluded. For those with a past history, please note medication, duration, dose and time frame on Medical History form.

Steroids: Oral and inhaled steroids are criteria for possible exclusion. Those on high dose (>3 mos.) will be excluded. Please note medication, duration, dose, and time frame on history. (Site specific injections are not grounds for exclusion.)

Thyroid Hormone: Not grounds for exclusion if proper dose is given; these actually compensate for an abnormal condition. Subjects will be excluded if dosage has changed within the last twelve months.

Statistical Methods

The raw data was processed by an independent statistician at the University of Wisconsin, Madison to fit scientifically and biologically relevant curves using step wise deletion of regression break points. The standard deviation was fitted to the curves forcing the standard deviations to be equal at the breakpoints but allowing the standard deviation to change with age.

Reference Sets Data Entry

Pictured below is an example screen used to enter the reference data. Refer to "Working with Reference Sets" on page 11-26 for instructions on enabling/disabling and editing reference sets.

Create Reference Set

Scan Type

AP Spine Hip Forearm Lateral Spine Whole Body Research Small Subject

AP Spine: L1
Hip: Fem. Neck
Forearm: Proximal Radius
Lateral Spine: L2
Whole Body: Total
Research: Small Subject

Reference Data

Title: Norland Rico
Ethnicity: Caucasian
Young Reference: 0.979
 Female Male N/A
Display By: Value I-Score
 Enabled

BMD BMC IBMC/FFM ST Fat % sBMD

AGE	Value	2 S.D.
20	0.979	0.2
50	0.919	0.2
90	0.671	0.2

Risk Bands	Levels
	0.879
	0.779
	0.679
	0.579

Save Close

WHO Criteria

The WHO criteria indicates that patients having T-Scores from +1 to -1 are considered to have normal bone density. Patients having T-Scores between -1 and -2.5 are considered osteopenic (low in bone mass) and at an increased risk of fracture. Patients having T-Scores below -2.5 are considered osteoporotic and have a high risk of fracture.

For detailed information regarding WHO criteria, please obtain a copy of the WHO Technical Report Number 843, entitled "Assessment of Fracture Risk and its Application to Screening for Postmenopausal Osteoporosis". It was published in 1994 by the World Health Organization, Geneva, Switzerland.

Norland Fracture Risk

Printed reports from all Norland scanners contain a graph plotting the BMD of the current scan against Fracture Risk information, based on the WHO criteria. An example of the graph is shown below. The appearance of the graph on any report may vary, based on the presence of Age-matched values or color versus black and white reports.

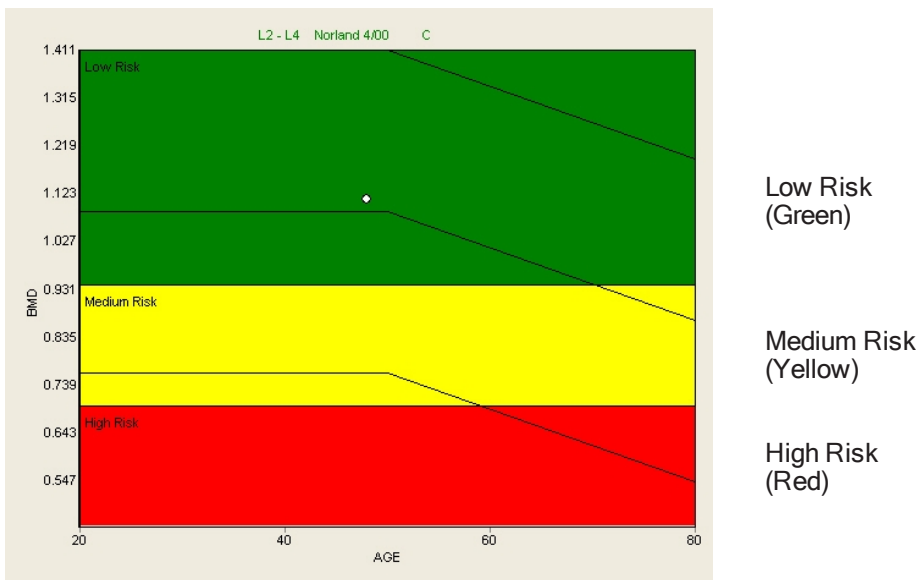

Figure 18-1: Fracture Risk Reference Set Chart (sample)

The upper area, labeled "Low Risk", represents the range of values termed by WHO to be "normal" - having adequate bone mineral. This is the region with T-Score values above minus 1 standard deviation, referenced to the young adult mean BMD value found in the reference population.

The middle area, labeled "Medium Risk", represents the range of values termed by WHO to be "osteopenic" - having reduced bone mineral. The BMD T-Score values in this region range between minus 1 standard deviation and minus 2.5 standard deviations. A patient whose value is plotted in this region may be susceptible to fracture.

The lower area, labeled "High Risk", represents the range of values termed by WHO to be "osteoporotic" - having severely reduced bone mineral. The BMD T-Score values in this region are more than 2.5 standard deviations below the young adult mean value. A patient whose value is plotted in this region has a high spontaneous fracture probability.

Excerpt from *Calcified Tissue International*

Calcif Tissue Int (1995) 57:469

Calcified
Tissue
International
© 1995 Springer-Verlag New York Inc.

Letter to the Editor

Standardization of Measurements for Assessing BMD by DXA

In a recent article, Genant et al. [1] published the results of a trial sponsored by the dual X-Ray absorptiometry (DXA) manufacturers Hologic, Lunar, and Norland to provide the basis for the standardization of measurement units used for the assessment of bone mineral density (BMD) by DXA. In a meeting of the Committee for Standards in DXA held during the annual meeting of the Radiological Society of North America in Chicago on November 30, 1994, the Committee gave final approval to the standardization of postero-anterior (PA) spine BMD measurements by DXA, as published by Genant et al.

In brief, effective September 1, 1995, all participating manufacturers will provide an option on newly shipped instruments which will permit users to select between spine BMD being reported with either the traditional, manufacturer-specific units in g/cm² or the standardized, nonmanufacturer-specific units in mg/cm². New systems will be configured to report standardized units by default. Upon request, software will be available from the manufacturers for upgrading existing instruments to provide the standardized units option.

The equations used to convert existing units (g/cm²) into standardized units (mg/cm²) for PA spine (L2-L4) BMD are as follows:

For Hologic instruments:

$$sBMD = 1000[BMD_{Hologic} \cdot 1.0755]$$

For Lunar instruments:

$$sBMD = 1000[BMD_{Lunar} \cdot 0.9522]$$

For Norland instruments:

$$sBMD = 1000[BMD_{Norland} \cdot 1.0761]$$

Spine BMD values obtained by scanning a patient on any one of these manufacturers instruments should fall within 2-5% of each other. These equations were determined such that, on average, the central vertebra of the ESP [2] reads 1000 mg/cm² on all scanners. However, the Committee for Standards in DXA does not endorse a single phantom for the determination of standardized units. The Committee believes that the equivalence of new DXA scanner types cannot be established by measuring a single object, regardless of whether that object is a phantom or a single patient. For that purpose, a study similar to the one described by Genant must be performed *in vivo* on individuals spanning the clinical range of BMD. Different phantoms are available from different manufacturers which, when used in accordance

with manufacturers' directions and specifications, can serve to verify instrument calibration and stability.

The Committee for Standards in DXA will continue its work to expand standardization to other anatomical sites assessed by DXA and will report periodically on its progress using Letters to the Editor as a means of communication.

Peter Steiger
Committee for Standards in DXA
Waltham, MA
USA

Committee members

Harry K. Genant, M.D.	University of California, San Francisco, CA, USA for the American Society for Bone and Mineral Research and the National Osteoporosis Foundation
Michael E. Grman	Norland Corporation, Fort Atkinson, WI, USA
Thomas Hangartner, Ph.D.	Wright State University, Dayton, OH, USA for the American Association of Physicists in Medicine and the National Osteoporosis Foundation
James Hanson, Ph.D.	Lunar Corporation, Madison, WI, USA—Committee Chairman
Willi A. Kalender, Ph.D.	University of Erlangen, Germany, for COMAC/BME
Richard Mazess, Ph.D.	Lunar Corporation, Madison, WI, USA
Rikushi Morita, M.D.	Japanese Society of Bone and Mineral Research, Japan
Hans Schiessl	Stratec Medizintechnik GMBH, Pforzheim, Germany
Peter Steiger, Ph.D.	Hologic Inc., Waltham, MA, USA
Jay Stein, Ph.D.	Hologic Inc., Waltham, MA, USA
Toshiaki Tamegai Ph.D.	Aloka Inc., Japan

References

1. Genant HK, Grampp S, Glüer CC, et al. (1994) Universal standardization for dual x-ray absorptiometry: patient and phantom cross-calibration results. *J Bone Miner Res* 9:1503-1514
2. Kalender WA, Felsenberg D, Genant HK, Fischer M, Dequeker J, Reeve J (in press) The European spine phantom: a tool for standardization and quality control in spinal bone mineral measurements by DXA and QCT. *Eur J Radiol*

Excerpt from the *Journal of Bone and Mineral Research*

JOURNAL OF BONE AND MINERAL RESEARCH
Volume 12, Number 8, 1997
Blackwell Science, Inc.
© 1997 American Society for Bone and Mineral Research

Letter to the Editor Standardization of Femur BMD

To the Editor:

The International Committee for Standards in Bone Measurement gave final approval to the standardization of proximal femur BMD measurements by DXA in a meeting held in Chicago on December 4, 1996. This follows earlier announcements on adoption of standardized units and spine standardization.^(1,2) Standardization of femur BMD measurements will include region of interest definition, units of measurement, and reference data.

The region of interest used for femur evaluations will be the Total Femur region of interest as used in NHANES III,⁽³⁾ SOF,⁽⁴⁾ PEPI,⁽⁵⁾ and other cross-sectional and prospective studies. These studies have demonstrated that the Total Femur region of interest is equally diagnostic but more precise than the Femoral Neck region of interest predominantly used prior to standardization. As part of the standardization effort, the Total Femur region of interest will be made available by all DXA manufacturers offering Standardized Femur BMD.

The Committee has decided to introduce the term "sBMD," expressed in mg/cm², to distinguish Standardized Femur BMD from manufacturer-specific "BMD," expressed in g/cm². The equations used to convert manufacturer-specific units [g/cm²] for Total Femur BMD into standardized units [mg/cm²] are as follows:

For Hologic Instruments:

$$sBMD = 1000[1.008 \times BMD_{Hologic} + 0.006]$$

For Lunar Instruments:

$$sBMD = 1000[0.979 \times BMD_{Lunar} - 0.031]$$

For Norland Instruments:

$$sBMD = 1000[1.012 \times BMD_{Norland} + 0.026]$$

sBMD values obtained by scanning a patient on any one of these manufacturers' instruments should fall within 3–6% of each other (3% standard error of estimate). These equations were based on the same study used to define sBMD for the spine⁽¹⁾ using an approach developed by Lu and colleagues.⁽⁶⁾ The method used does not require a gold standard and minimizes variance observed between standardized and manufacturer-specific BMD values on all instruments. For new devices entering the market to comply with Standardized Femur BMD a study similar to the one employed here will be required. Such a study would measure a wide range of BMD in human subjects on different scanners and derive Standardized Femur BMD using the method of Lu et al.

The standardization of Total Femur BMD includes the standardization of reference data, thereby making T- and Z-scores derived from different manufacturers' equipment compatible. The data used as the basis for the reference ranges were collected in phases 1 and 2 of the third National Health and Nutrition Examination Survey (NHANES III, 1988–1994).⁽³⁾ The reference data curve was generated based on running means of the raw data. The mean sBMD and standard deviation for the young adult reference for 409 U.S. white women aged 20–29 years was 956 mg/cm² and 123 mg/cm², respectively. Age-specific reference data based on a total of 3,251 U.S. white women are listed in Table 1.

Standardized Femur BMD will be made available on newly-shipped devices no later than September 1, 1997, by all participating manufacturers. Users will be provided with an option that will permit Femur BMD to be reported with either the traditional, manufacturer-specific units in g/cm² (for any of the traditional femur regions of interest) or the standardized, non-manufacturer-specific units in mg/cm² for the Total Femur region of interest. New systems will be configured to report standardized units by default. Upon request, software will be available from the manufacturers for upgrading existing instruments to provide the standardized units option.

As part of the standardization effort the Committee will collaborate with the relevant scientific and professional societies as well as the regulatory agencies to promote the utilization of Standardized Femur BMD instead of the current, widely-employed, manufacturer-specific Femoral Neck BMD. The medical community should welcome manufacturers' independent T- and Z-scores for diagnosis at the

TABLE 1. STANDARDIZED TOTAL FEMUR REFERENCE DATA FOR WHITE WOMEN

Age (years)	Reference sBMD (mg/cm ²) for women
20–29	956
30–39	944
40–49	920
50–59	876
60–69	809
70–79	740
80+	679

The standard deviation is 123 mg/cm².

LETTER TO THE EDITOR

1317

Total Femur region of interest. This will eliminate the currently observed inter-manufacturer discrepancy associated with clinical decision-making based on T- and Z-scores at the femur neck region of interest.

The Committee for Standards in Bone Measurement, a voluntary committee of representatives of both industry and the academic community, has provided users of DXA technology the three critical components for standardization of DXA scan results: standardized units in mg/cm², a standardized definition of scan regions of interest for spine and femur, and agreement on a universal reference database for the femur, based on NHANES III. This significant accomplishment makes comparisons of data between DXA devices and between manufacturers possible. The clinical benefits of these efforts are evident in greater confidence in scan results, clearer definition of patient condition when applying WHO criteria, ability to compare data between scans performed on different devices, and expanded reference data for the United States. The committee also agreed to update reference data from time-to-time as new information becomes available for additional populations. Standardization of male Total Femur reference data will be completed when the final NHANES data are published. The committee understands that population-based reference data equivalent to NHANES are being evaluated by the European Foundation for Osteoporosis. The need for geographic dependent reference data will be addressed by the committee. The committee will continue its work to expand standardization to other anatomical sites assessed by DXA and will report periodically on its progress using letters to the editor as means for communication.

REFERENCES

1. Genant HK, Grampp S, Glüer CC, Faulkner KG, Jergas M, Engelke K, Hagiwara S, Van Kuijk C 1994 Universal standardization for dual x-ray absorptiometry: Patient and phantom cross-calibration results. *J Bone Miner Res* **9**:1503-1514.
2. Steiger P 1995 Letter to the editor: Standardization of spine BMD measurements. *J Bone Miner Res* **10**:1602-1603.
3. Looker AC, Johnston CC Jr., Wahner HW, Dunn WL, Calvo MS, Harris TB, Heyse SP, Lindsay RL 1995 Prevalence of low femoral bone density in older US women from NHANES III. *J Bone Miner Res* **10**:796-802.
4. Cummings SR, Black DM, Nevitt MC, Browner W, Cauley J, Ensrud K, Genant HK, Palermo L, Scott J, Vogt TM 1993 Bone density at various sites for prediction of hip fractures. *Lancet* **341**:72-75.
5. Bush TL, Wells HB, James MK, Barrett-Connor E, Marcus R, Greendale G, Hunsberger S, McGowan J 1996 Effects of hormone therapy on bone mineral density. *JAMA* **276**:1389-1396.
6. Lu Y, Ye K, Mathur AK, Hui S, Fuerst T, Genant HK 1997 Comparative calibration without a gold standard. *Stat Med* (in press).

Address reprint requests to:
Jim Hanson, Ph.D.
 for the International Committee
 for Standards in Bone Measurement
 Lunar Corporation
 313 West Beltiline Highway
 Madison, WI 53713 U.S.A.

COMMITTEE MEMBERS

Dieter Felsenberg, M.D.	Freie Universitat Berlin, Radiology, Steglitz Med Centre, Berlin, Germany, for COMAC/BME
Thomas Fuerst, Ph.D.	University of California, San Francisco, CA, U.S.A., Department of Radiology
Harry K. Genant, M.D.	University of California, San Francisco, CA, U.S.A. for the American Society for Bone and Mineral Research and the National Osteoporosis Foundation
Thomas Hangartner, Ph.D.	Wright State University, Dayton, OH, U.S.A. for the American Association of Physicists in Medicine and the National Osteoporosis Foundation
James Hanson, Ph.D.	Lunar Corporation, Madison, WI, U.S.A. - Committee Chairman
Lewis Harrold, VP Engineering	Norland Corporation, Fort Atkinson, WI, U.S.A.
C. Conrad Johnston, Jr., M.D.	Indiana University School of Medicine, Indianapolis, IN, U.S.A., for the National Osteoporosis Foundation
Willi A. Kalender, Ph.D.	University of Erlangen, Germany, for COMAC/BME
Ying Lu, Ph.D.	University of California, San Francisco, CA, U.S.A., Dept. of Radiology
Richard Mazess, Ph.D.	Lunar Corporation, Madison, WI, U.S.A.
Paul D. Miller, M.D.	Colorado Center for Bone Research, P.C., Lakewood, CO, U.S.A., for the International Society of Clinical Densitometry
Rikushi Morita, M.D., Ph.D.	Shiga University, Otsu City, Japan, for the Japanese Society of Bone and Mineral Research
Akira Nakamura, Gen. Mgr.	Aloka Co., Ltd. Tokyo Works, Tokyo, Japan
Russell Nord, Ph.D.	Lunar Corporation, Madison, WI, U.S.A.
Jonathan Reeve, DM, DS, FRCP	Institute of Public Health, University Forvie Site, Cambridge, U.K., for the European Foundation for Osteoporosis
Hans Schiessl	Stratec Medizintechnik GMBH, Pforzheim, Germany
Peter Steiger, Ph.D.	Hologic Inc., Waltham, MA, U.S.A.
Jay Stein, Ph.D.	Hologic Inc., Waltham, MA, U.S.A.
Eric von Stetten, Ph.D.	Hologic Inc., Waltham, MA, U.S.A.
Toshiaki Tamegai Ph.D.	Aloka Co., Ltd., Tokyo, Japan
Georg Tysarczyk-Niemeyer	Stratec Medizintechnik GmbH, Pforzheim, Germany

Norland Reference Data Set Values

Table 18-1: Norland Reference Data Set Values

Ethnic	Gender	Scan Type	Region	Title	Young Reference	Standard Deviation	Age 20 BMD	Age 50 BMD	Age 80 BMD	Low Risk	Medium Risk	High Risk	Enabled
Asian (A)	Female	AP Spine	L1	Norland 4/00	1.005	0.129	---	---	---	0.876	0.6825	0.489	Y
			L2	Norland 4/00	1.061	0.132	---	---	---	0.929	0.731	0.533	Y
			L3	Norland 4/00	1.090	0.130	---	---	---	0.960	0.765	0.570	Y
			L4	Norland 4/00	1.036	0.127	---	---	---	0.909	0.7185	0.528	Y
			L1-L4	Norland 4/00	1.043	0.125	---	---	---	0.918	0.7305	0.543	Y
			L2-L4	Norland 4/00	1.062	0.126	---	---	---	0.936	0.747	0.558	Y
			Total Spine	Norland 4/00	1142	135	---	---	---	1007	804.5	602	Y
		Hip	Fem Neck	Norland 4/00	0.866	0.113	---	---	---	0.753	0.5835	0.414	Y
			Troch	Norland 4/00	0.697	0.108	---	---	---	0.589	0.427	0.265	Y
			Ward's Tri	Norland 4/00	0.712	0.128	---	---	---	0.584	0.392	0.200	Y
		Total Hip	Norland 4/00	929	117	---	---	---	812	636.5	461	Y	
Black (B)	Female	AP Spine	L1	Norland 4/00	1.206	0.140	---	---	---	1.066	0.856	0.646	Y
			L2	Norland 4/00	1.256	0.139	---	---	---	1.117	0.9085	0.700	Y
			L3	Norland 4/00	1.259	0.136	---	---	---	1.123	0.919	0.715	Y
			L4	Norland 4/00	1.216	0.127	---	---	---	1.089	0.8985	0.708	Y
			L1-L4	Norland 4/00	1.239	0.126	---	---	---	1.113	0.924	0.735	Y

Norland Reference Data Set Values (continued)

Ethnic	Gender	Scan Type	Region	Title	Young Reference	Standard Deviation	Age 20 BMD	Age 50 BMD	Age 80 BMD	Low Risk	Medium Risk	High Risk	Enabled
			L2-L4	Norland 4/00	1.243	0.127	---	---	---	1.116	0.9255	0.735	Y
			Total Spine	Norland 4/00	1338	137	---	---	---	1201	995.5	790	Y
		Hip	Fem Neck	Norland 4/00	1.046	0.140	---	---	---	0.906	0.696	0.486	Y
			Troch	Norland 4/00	0.797	0.125	---	---	---	0.672	0.4845	0.297	Y
			Ward's Tri	Norland 4/00	0.852	0.164	---	---	---	0.688	0.442	0.196	Y
			Total Hip	Norland 4/00	1081	140	---	---	---	941	731	521	Y
Black (B)	Male	AP Spine	L1	Norland 4/00	1.232	0.184	---	---	---	1.048	0.772	0.496	Y
			L2	Norland 4/00	1.291	0.204	---	---	---	1.087	0.781	0.475	Y
			L3	Norland 4/00	1.309	0.215	---	---	---	1.094	0.7715	0.449	Y
			L4	Norland 4/00	1.279	0.201	---	---	---	1.078	0.7765	0.475	Y
			L1-L4	Norland 4/00	1.271	0.191	---	---	---	1.080	0.7935	0.507	Y
			L2-L4	Norland 4/00	1.293	0.202	---	---	---	1.091	0.788	0.485	Y
			Total Spine	Norland 4/00	1391	218	---	---	---	1173	846	519	Y
		Hip	Fem Neck	Norland 4/00	1.161	0.205	---	---	---	0.956	0.6485	0.341	Y
			Troch	Norland 4/00	0.933	0.181	---	---	---	0.752	0.4805	0.209	Y
			Ward's Tri	Norland 4/00	0.939	0.217	---	---	---	0.722	0.3965	0.071	Y
			Total Hip	Norland 4/00	1188	198	---	---	---	990	693	396	Y
Caucasian (C)	Female	AP Spine	L1	Norland 4/00	1.029	0.155	1.034	1.034	0.779	0.874	0.6415	0.409	Y

Norland Reference Data Set Values (continued)

Ethnic	Gender	Scan Type	Region	Title	Young Reference	Standard Deviation	Age 20 BMD	Age 50 BMD	Age 80 BMD	Low Risk	Medium Risk	High Risk	Enabled
			L2	Norland 4/00	1.097	0.163	1.094	1.094	0.824	0.934	0.6895	0.445	Y
			L3	Norland 4/00	1.115	0.171	1.108	1.108	0.885	0.944	0.6875	0.431	Y
			L4	Norland 4/00	1.082	0.169	1.063	1.063	0.893	0.913	0.6595	0.406	Y
			L1-L4	Norland 4/00	1.086	0.159	1.074	1.074	0.851	0.927	0.6885	0.450	Y
			L2-L4	Norland 4/00	1.102	0.162	1.087	1.087	0.869	0.940	0.697	0.454	Y
			Spine sBMD	Norland 4/00	1186	175	1170	1170	935	1011	748.5	486	Y
		Hip	Fem Neck	Norland 4/00	0.987	0.117	0.981	0.873	0.655	0.870	0.6945	0.519	Y
			Troch	Norland 4/00	0.787	0.109	0.775	0.699	0.559	0.678	0.5145	0.351	Y
			Ward's Tri	Norland 4/00	0.851	0.125	0.848	0.674	0.441	0.726	0.5385	0.351	Y
		Forearm	Distal	Norland 798	0.3191	0.04822	0.3191	0.3211	0.2039 *	0.27088	0.19855	0.12622	Y
Caucasian (C)	Female	Forearm	Proximal	Norland 798	0.7127	0.06237	0.7127	0.7276	0.4553 *	0.65033	0.556775	0.46322	Y
			P Radius	Norland 798	0.7181	0.063265	0.7181	0.7260	0.4546 *	0.654835	0.559938	0.465040	Y
		Forearm H	Distal	Norland 798	0.3567	0.0539	0.3567	0.3589	0.2279 *	0.3028	0.22195	0.1411	Y
			Proximal	Norland 798	0.8552	0.07484	0.8552	0.8731	0.5463 *	0.78036	0.66810	0.55584	Y
			P Radius	Norland 798	0.8481	0.07472	0.8481	0.8575	0.5369 *	0.77338	0.66130	0.54922	Y
	Male	AP Spine	L1	Norland 4/00	1.105	0.167	1.096	1.066	1.036	0.938	0.6875	0.437	Y
			L2	Norland 4/00	1.171	0.186	1.158	1.127	1.097	0.985	0.706	0.427	Y
			L3	Norland 4/00	1.181	0.191	1.165	1.146	1.127	0.990	0.7035	0.417	Y

Norland Reference Data Set Values (continued)

Ethnic	Gender	Scan Type	Region	Title	Young Reference	Standard Deviation	Age 20 BMD	Age 50 BMD	Age 80 BMD	Low Risk	Medium Risk	High Risk	Enabled
			L4	Norland 4/00	1.134	0.199	1.126	1.126	1.126	0.935	0.6365	0.338	Y
			L1-L4	Norland 4/00	1.148	0.176	1.130	1.119	1.107	0.972	0.708	0.444	Y
			L2-L4	Norland 4/00	1.164	0.184	1.146	1.133	1.121	0.980	0.704	0.428	Y
			Total Spine	Norland 4/00	1253	198	1233	1219	1206	1055	758	461	Y
		Hip	Fem Neck	Norland 4/00	1.108	0.125	1.111	0.940	0.770	0.983	0.7955	0.608	Y
			Troch	Norland 4/00	0.933	0.113	0.925	0.838	0.751	0.820	0.6505	0.481	Y
			Ward's Tri	Norland 4/00	0.908	0.126	0.905	0.680	0.456	0.782	0.593	0.404	Y
			Total Hip	Norland 4/00	1147	123	1150	1027	903	1024	839.5	655	Y
Cauc-Hisp (CH)	Female	AP Spine	L1	Norland 4/00	1.054	0.152	1.041	1.041	0.775	0.902	0.674	0.446	Y
			L2	Norland 4/00	1.124	0.159	1.100	1.100	0.820	0.965	0.7265	0.488	Y
			L3	Norland 4/00	1.133	0.167	1.112	1.112	0.882	0.966	0.7155	0.465	Y
			L4	Norland 4/00	1.084	0.165	1.066	1.066	0.892	0.919	0.6715	0.424	Y
			L1-L4	Norland 4/00	1.101	0.156	1.080	1.080	0.848	0.945	0.711	0.477	Y
			L2-L4	Norland 4/00	1.115	0.158	1.091	1.091	0.866	0.957	0.720	0.483	Y
			Total Spine	Norland 4/00	1200	170	1174	1174	932	1030	775	520	Y
Cauc-Hisp (CH)	Female	Hip	Fem Neck	Norland 4/00	0.995	0.116	0.993	0.871	0.656	0.879	0.705	0.531	Y
			Troch	Norland 4/00	0.779	0.108	0.772	0.698	0.560	0.671	0.509	0.347	Y
			Ward's Tri	Norland 4/00	0.846	0.124	0.849	0.674	0.442	0.722	0.536	0.350	Y

Norland Reference Data Set Values (continued)

Ethnic	Gender	Scan Type	Region	Title	Young Reference	Standard Deviation	Age 20 BMD	Age 50 BMD	Age 80 BMD	Low Risk	Medium Risk	High Risk	Enabled
			Total Hip	Norland 4/00	1022	118	1010	920	741	904	727	550	Y
	Male	AP Spine	L1	Norland 4/00	1.109	0.167	1.096	1.065	1.034	0.942	0.6915	0.441	Y
			L2	Norland 4/00	1.176	0.187	1.160	1.125	1.089	0.989	0.7085	0.428	Y
			L3	Norland 4/00	1.183	0.191	1.166	1.142	1.119	0.992	0.7055	0.419	Y
			L4	Norland 4/00	1.138	0.199	1.122	1.122	1.122	0.939	0.6405	0.342	Y
			L1-L4	Norland 4/00	1.152	0.176	1.130	1.118	1.106	0.976	0.712	0.448	Y
			L2-L4	Norland 4/00	1.168	0.185	1.147	1.130	1.113	0.983	0.7055	0.428	Y
			Total Spine	Norland 4/00	1257	199	1234	1216	1198	1058	759.5	461	Y
		Hip	Fem Neck	Norland 4/00	1.107	0.126	1.109	0.939	0.769	0.981	0.792	0.603	Y
			Troch	Norland 4/00	0.928	0.114	0.919	0.835	0.751	0.814	0.643	0.472	Y
			Ward's Tri	Norland 4/00	0.900	0.128	0.898	0.678	0.457	0.772	0.580	0.388	Y
			Total Hip	Norland 4/00	1146	124	1147	1025	903	1022	836	650	Y
Hispanic (H)	Female	AP Spine	L1	Norland 4/00	1.088	0.126	---	---	---	0.962	0.773	0.584	Y
			L2	Norland 4/00	1.149	0.122	---	---	---	1.027	0.844	0.661	Y
			L3	Norland 4/00	1.144	0.126	---	---	---	1.018	0.829	0.64	Y
			L4	Norland 4/00	1.080	0.121	---	---	---	0.959	0.7775	0.596	Y
			L1-L4	Norland 4/00	1.112	0.119	---	---	---	0.993	0.8145	0.636	Y
			L2-L4	Norland 4/00	1.123	0.117	---	---	---	1.006	0.8305	0.655	Y

Norland Reference Data Set Values (continued)

Ethnic	Gender	Scan Type	Region	Title	Young Reference	Standard Deviation	Age 20 BMD	Age 50 BMD	Age 80 BMD	Low Risk	Medium Risk	High Risk	Enabled
			Total Spine	Norland 4/00	1207	128	---	---	---	1079	887	695	Y
Hispanic (H)	Female	Hip	Fem Neck	Norland 4/00	0.982	0.111	---	---	---	0.871	0.7045	0.538	Y
			Troch	Norland 4/00	0.740	0.103	---	---	---	0.637	0.4825	0.328	Y
			Ward's Tri	Norland 4/00	0.800	0.125	---	---	---	0.675	0.4875	0.300	Y
			Total Hip	Norland 4/00	1021	109	---	---	---	912	748.5	585	Y

* This reference set has Age-Matched values for ages 20, 50, and 90.

NHANES III Reference Data Set Values

Table 18-2: NHANES III Reference Data Set Values

Ethnic	Gender	Region Type	Young Reference	Standard Deviation	Age 20 BMD	Age 25 BMD	Age 35 BMD	Age 45 BMD	Age 55 BMD	Age 65 BMD	Age 75 BMD	Age 85 BMD	Low Risk	Medium Risk	High Risk
Caucasian	Female	Hip sBMD	956	123	956	956	944	920	876	809	740	679	833	648.5	464

This page intentionally left blank.

Index

A

About command 3-52

About this Manual 1-4

Accessories 2-6

 Calibration Standard 2-6

 head support pillow 2-7

 patient positioning aids 2-7

 QC Phantom 2-6

Accuracy & Precision, attaining 4-2

Accuracy description 2-10

Add

 new patient 3-17

 region (see Include) 11-45

Address Book 11-12

Advanced Preferences command 3-40

Aids, patient positioning 10-10

Aladdin USB HASP key 3-6

Alternate R-Value Analysis 11-71, 11-71

 Preferences 3-33

Analysis

 AP Spine options 3-32

 AP Spine preferences 3-32

 AP Spine scan 7-17

 bone mineral 2-8

 Forearm options 3-34

 Hip options 3-33

 Hip scan 8-23, 8-25

 Image Enhancement 3-31

 Lateral options 3-36

 Lateral Spine scan 10-21, 10-23

 Research 9-16

 Research/Small Subject options 3-37

 Small Subject 9-16

 Whole Body options 3-35

 Whole Body scan 5-15

Analyzing Saved Scan Data 11-59

Angulated cursors

 modifying 11-67

 selection 3-32

AP Leg Rest Block (see Leg Rest Block) 7-11

AP Spine

 analysis options 3-32

 Analyzing saved scan data 11-59

 analyzing the scan 7-17

 Auto Centering Parameter 11-65

 Bone Exam Report 7-26

 checklist 7-7

 Comparison Image 11-54, 11-56

 high quality scans 7-4

 leg rest blocks, using 7-11

 Marking the Scan Region 7-12

 Measure Scan 7-14

 patient positioning 7-10

 Quick Reference Guide 7-6, Q-1

 Results tab 7-21

 scan overview 7-1

 Scan Procedure 7-7

 scan specifications 7-2

 setting analysis defaults 3-32, 3-32

 setting parameters 3-24

 setting scan defaults 3-24

Articles

 Excerpt from 'Calcified Tissue International' 18-7

 Excerpt from the Journal of Bone and Mineral Research 18-8

Letter to the Editor 18-8

Audible indicator 2-3, 4-2

Audio

- Dictation command 3-48
- microphone 11-2
- overview 11-2

Audio Dictation

- buttons 11-5
- controls 11-5
- how to add to a recording 11-6
- how to delete a recording 11-7
- how to play back 11-6
- how to record 11-5
- icon 11-2, 11-5
- overview 11-2
- play back 11-6
- recording 11-6

Auto Centering, AP Spine Scan 11-65

B

Back Rest Block, positioning 10-10

Backup

- Configuring 3-6
- Windows 10 15-3
- Windows 7 15-4

Beam Quality Information 17-11

Beep (see Audible Indicator) 2-3

Begin Initial Calibration command 3-51

Begin QA Calibration 4-8

Begin QA Calibration command 3-47

Beginning the patient scan 4-33

Billing information field 4-26

Blocks

- lateral positioning 2-7
- leg rest 2-7
- leg separator 2-7

BMD QA Report 2-31, 4-14

Body Composition Report 2-28, 6-11

Body fat Charts 6-5

Bone Exam Report

- AP Spine scan 7-26
- details 2-17
- Hip scan 8-31
- Lateral Spine scan 10-28
- Research scan 9-22
- Soft Tissue Composition Research scan 6-9
- Whole Body scan 5-22

Bone Exam Report - 1 Page 2-20

Bone History Field 4-26

Bone mineral analysis techniques 2-8

BROZEK underwater weighing 6-4

Buttons, Scanner Arm Touch Pad 2-5

C

C.V.

- AP Spine scan 7-2
- description 2-10
- Hip scan 8-2
- Lateral scan 10-2
- Soft Tissue Composition scan 6-3
- used in an equation 2-9
- Whole Body scan 5-2

Calcium phosphate tribasic 6-2

Calibrate system 4-8

Calibration

- Begin QA 4-8
- Begin QA command 3-47
- BMD results display 4-13
- daily procedure 4-6, 4-15
- daily procedure overview 2-8
- failure 4-6, 4-17
- how to stop the 4-17
- QC Scan command 3-47
- repeat 4-17

- Results command 3-47
- results interpretation 4-18, 4-19
- stop the 4-17
- when to repeat the 4-17
- Calibration menu commands
 - Begin QA 3-47
 - QC Scan 3-47
 - Results 3-47
- Calibration Standard
 - check for damage 4-6
 - damaged 4-6
 - description 2-6
 - picture 4-6, 4-6
 - positioning 4-7
- Canceling a Hip Scan 11-70
- Cautions
 - AP Spine scanning, general 5-4, 7-5, 8-5, 9-5, 10-5
 - general 17-13
 - IMPSO 17-14
 - scanner arm movement 4-4
 - specific 17-15
 - symbol 1-6
- CCC Mark
 - label location 17-17
- Certification, ISO 13485 1-1
- Changing the Scan Parameters
 - AP Spine 11-63
 - Hip 11-69
 - Lateral Spine 11-76
 - Research & Small Subject 11-78
 - Whole Body 11-75
- Checklist
 - AP Spine Scan 7-7
 - Hip Scan Procedure 8-7
 - Lateral Spine Scan 10-7
 - Research Scan 9-7
 - Small Subject Scan 9-7
 - Whole Body Scan 5-6
- Classification specifications 17-4
- Cleaning
 - Positioning Aids 15-2
 - QC phantom 15-2
 - scanner exterior 15-2
 - table top pad 15-2
- Coefficient of Variation (see C.V.) 5-2
- Comac Forearm scans, conversion of 11-74
- Commands
 - About 3-52
 - Advanced Preferences 3-40
 - Audio Dictation 3-48
 - Begin Initial Calibration 3-51
 - Begin QA Calibration 3-47
 - Calibration Menu drop down 3-47
 - Database 3-17
 - Edit Menu drop down 3-18
 - Exit 3-17
 - File 3-17
 - File Tools 3-48, 3-48
 - Find Origin 3-49
 - Groups 3-45
 - Help Menu drop down 3-52
 - Help Topics 3-52
 - Import FolderMail 3-17
 - Initialize Scanner 3-48
 - Logout 3-17
 - Mail 3-48
 - New Patient 3-17
 - QC Scan 3-47
 - Reference Sets 3-17
 - Report Generator 3-48
 - Results Calibration 3-47
 - Runtime Log 3-48
 - Send To 3-48

- Service Tools [3-48](#)
- Swissray, link to Web page [3-52](#)
- Table Limits [3-50](#)
- Tools Menu drop down [3-48](#)
- User Preferences [3-20](#)
- Users and Groups [3-45](#)
- Comments field [4-28](#)
- Communication Watchdog [2-3](#)
- Comparison
 - reference set [2-10](#)
 - trend overview [2-9](#)
- Comparison Image command [11-54](#), [11-56](#)
- Computer
 - beep (see Audible indicator) [2-6](#)
 - certification label [17-22](#)
 - certified X-Ray Controller [2-6](#)
 - description [17-2](#)
 - maintenance [15-5](#)
 - power up [4-3](#)
 - system component [2-6](#)
- Computer description [17-2](#)
- Contact Norland Service [1-3](#)
- Control Panel (see Scanner Arm Touch Pad) [2-5](#)
- Controller label [17-22](#)
- Conversion of Comac Forearm Scans [11-74](#)
- Cooling curves [17-5](#)
- Corrective Procedures [15-5](#)
- Create a Reference Set [11-27](#)
- Creating a Database folder [11-15](#)
- Cursors, adding Special Region [11-38](#)
- Customer Info tab [3-40](#)
- Customer service contact information [1-3](#)
- CV (see C.V.) [7-2](#)

D

- Daily System Calibrations (see Calibration) [4-6](#)

- Damage
 - check Calibration Standard for [4-6](#)
 - check QC Standard for [4-6](#)
- Database
 - add new patient [3-17](#)
 - add to list [11-17](#)
 - command [3-17](#)
 - creating a folder [11-15](#)
 - deleting files [11-22](#)
 - exporting [11-20](#)
 - importing a [11-18](#)
 - management [11-14](#)
 - remove from list [11-16](#)
- Database Management [11-14](#)
- Database Navigator window [3-14](#)
- DB Extract [14-1](#)
 - available parameters [14-9](#)
 - for patient [14-9](#)
 - for regions [14-13](#)
 - for scans [14-11](#)
 - for visits [14-10](#)
 - basic information [14-1](#)
 - displaying total patients [14-3](#)
 - displaying total scans [14-3](#)
 - exporting data [14-8](#)
 - invoking [14-2](#)
 - parameters
 - to add [14-4](#)
 - to move [14-4](#)
 - to remove [14-4](#)
 - to select [14-4](#)
 - patient filtering [14-5](#)
 - by name or ID [14-5](#)
 - by scan date [14-5](#)
 - by scan type [14-5](#)
 - selecting source [14-3](#)
 - setups [14-7](#)

- Default settings
 - AP Spine parameters 3-24
 - Forearm scanning parameters 3-26
 - Hip scanning parameters 3-25
 - Lateral Spine scanning parameters 3-28, 3-28
 - Research/Small Subject scanning parameters 3-29
 - Whole Body scanning parameters 3-27
 - Whole Body scanning parameters 3-27
 - Delete
 - Audio Dictation 11-7
 - patient file 11-22
 - Reference Set 11-32
 - region (see Exclude) 11-49
 - scan image 11-24
 - visit 11-23
 - Voice Note 11-4
 - Demographics window, new patient 4-21
 - Description
 - Computer 17-2
 - Diagnostic tests, automatic 4-11
 - DICOM
 - Quick Reference Guide 13-9, Q-4
 - DICOM compatible Report 2-13
 - DICOM Interface 13-1
 - Data patient conflict 13-13
 - Definitions 13-2
 - Delete button 13-15
 - Delete operation 13-17
 - Device tab 13-6
 - exporting images 13-14
 - invoking the 13-3
 - Job Queue 13-18
 - Modality Value 13-8
 - Modality Worklist 13-5
 - patient files 13-3
 - Preferences dialog box 13-4
 - Preferences, Advanced 13-7
 - Push button 13-15
 - Query results 13-11
 - Refresh file listing 13-17
 - Requirements 13-2
 - Services menu, Patient Worklist 13-10
 - Services menu, Queue 13-18
 - Site Information 13-4
 - Site tab 13-4
 - Dimensions, System 17-3
 - Directories tab 3-42
 - Disable a Reference Set 11-31
 - Disabled, scanning 4-6
 - Dose
 - operator, AP Spine 7-3
 - operator, Hip scan 8-3
 - operator, Lateral Spine scan 10-3
 - operator, Research scan 9-3
 - operator, Small Subject scan 9-3
 - operator, Whole Body scan 5-2
 - patient, AP Spine scan 7-3, 7-3
 - patient, Lateral Spine scan 10-3
 - patient, Research scan 9-3
 - patient, Small Subject scan 9-3
 - patient, Whole Body scan 5-2
 - specifications 17-3
 - Dual Energy X-ray Absorptiometry, definition 2-4
 - Duty cycle specifications 17-5
 - DXA 2-4
 - DynaFlux 2-4
 - Dynamic filtering 2-4
- ## E
- Edit a Reference Set 11-31
 - Edit menu commands 3-18
 - Advanced Preferences 3-40
 - Groups 3-45

- User Preferences [3-20](#)
- Users and Groups [3-45](#)
- Electrical requirements [17-5](#)
- Emergency Stop button
 - pressing the [11-37](#)
 - Scanner Arm Touch Pad [2-3](#)
- EmpiriCAL [2-6](#)
- Enable a Reference Set [11-31](#)
- Environmental specifications [17-2](#)
- Examining the Software [3-13](#)
- Exclude
 - overview [11-45](#)
 - procedures [11-49](#)
- Existing patient
 - locating a record [4-22](#)
 - record preparation [4-24](#)
- Exit command [3-17](#)
- Export a Report as a PDF [2-13](#)
- Export PDF [11-7](#)
- Exporting a Database [11-20](#)
- Exposure Indicators [2-3](#)

F

- Fat QA Report [2-32](#), [4-15](#)
- Fault Diagnosis (see Troubleshooting) [16-1](#)
- FCC Statement [17-6](#)
- Features, operational [17-2](#)
- File command
 - Database [3-17](#)
 - Import FolderMail [3-17](#)
 - New Patient [3-17](#)
 - Reference Sets [3-17](#)
- File Menu commands (see Commands) [3-17](#)
- File Tools command [3-48](#), [3-48](#)
- Find Origin command [3-49](#)
- FolderMAIL
 - address book [11-12](#)

- import to a Database [11-13](#)
- not active [16-9](#)
- overview [11-9](#)
- sending [11-9](#)

- Force Mark Points On-Axis [11-66](#)

- Forearm
 - analysis defaults [3-34](#)
 - Analyzing saved scan data [11-59](#)
 - Comac scans [11-74](#)
 - Comparison Image [11-54](#), [11-56](#)
 - Hydroxyapatite analysis [11-74](#)
 - scanning techniques, additional [11-74](#)
 - setting parameters [3-26](#)
 - setting scan defaults [3-26](#)

- Fracture Risk
 - assessment, WHO criteria [2-11](#)
 - sample chart [2-10](#)
 - WHO criteria [2-11](#)

- Fuse Ratings [17-11](#)

G

- General cautions [17-13](#)
- Generate a Report
 - AP Spine Scan [7-24](#)
 - Hip scan [8-29](#)
 - Lateral Spine scan [10-26](#)
 - Research scan [9-20](#)
 - Small Subject scan [9-20](#)
 - Soft Tissue Composition [6-7](#)
 - Ten Year Fracture Risk [12-6](#)
 - Whole Body scan [5-20](#)
- Get a Reference Set [11-29](#)
- Guidelines for precision & accuracy [4-2](#)

H

- HASP key, USB [3-6](#)
- Head Roll [10-10](#)

- Height and Weight, Changing 11-62
 - Height field 4-26
 - Help menu commands
 - About 3-52
 - Help Topics 3-52
 - Swissray 3-52
 - High Density Point Exclusion 3-35
 - AP Spine analysis 3-32
 - Forearm analysis 3-34
 - Hip analysis 3-33
 - Lateral Spine analysis 3-36
 - Research analysis 3-37
 - Small Subject analysis 3-37
 - Whole Body analysis 3-35
 - High risk, fracture assessment 2-11
 - Hip
 - Alternate R-Value Analysis 11-71
 - analysis defaults 3-33
 - Analyzing saved scan data 11-59
 - Bone Exam Report 8-31
 - canceling a scan 11-70
 - changing scan parameters 11-69
 - Comparison Image 11-54, 11-56
 - high quality scans 8-4
 - locating femoral neck 8-16, 8-17
 - Marking the scan region 8-16
 - Measure scan 8-21
 - patient positioning 8-10
 - Quick Reference Guide 8-6, 2
 - scan defaults 3-25
 - scan parameters 3-25
 - scan specifications 8-2
 - scanning procedure 8-7, 8-22
 - scanning techniques, additional 11-69
 - Scout scan 8-18
 - unsatisfactory scout scan 11-70
 - Hip Fracture Risk, Ten Year 12-1
 - Hip Sling
 - part number 2-7
 - using the 8-11, 8-14
 - Histogram 7-17
 - Hydroxyapatite 11-74
 - Hydroxyapatite Standard 2-10, 6-2
- ## I
- Icons
 - Audio Dictation 11-2, 11-5
 - Illuminatus DXA software 4-4
 - on the desktop 3-12
 - Voice Note 11-2
 - Identification Label 17-19, 17-19
 - Image
 - delete a scan 11-24
 - exporting a DICOM image 13-14
 - Include/Exclude 11-45
 - ImageMAIL
 - address book 11-12
 - Imaging 11-56
 - composition types 11-56
 - default composition 11-56
 - default mode 11-57
 - generating reports using 11-57
 - mode types 11-57
 - Implants, scanning 1-2
 - Import FolderMail command 3-17
 - Importing a Database 11-18
 - Include feature
 - overview 11-45
 - procedures 11-45
 - Indications for use, contraindications 1-2
 - Indicators
 - audible 2-3
 - laser 2-6
 - READY 2-3

- visible, exposure 2-3
- X-RAY 2-3
- Initialize Scanner command 3-48
- Installation
 - introduction 3-1
 - microphone 3-7
 - software 3-2
 - specifications 17-5
- Instructions (see Quick Reference Guide) 7-6, 13-9, Q-1, Q-4
- Instrument Components (see System Components) 2-5
- Introduction 1-2
- ISO 13485 Certified 1-1

- K**
- K-edge filtration 2-4, 2-5
- Keypad (see Scanner Arm Touch Pad) 2-5

- L**
- Label
 - beam limiter 17-19
 - caution 17-19
 - controller (computer) certification 17-22
 - danger 17-19
 - export 17-20, 17-21
 - fuse 17-22
 - identification 17-19, 17-19
 - locations 17-17
 - mains 17-20, 17-21
 - mechanical hazard 17-20, 17-21
 - power entry module 17-22
 - receptacle 17-22
 - scanner 17-19
 - serial number 17-19, 17-19
 - storage 17-20, 17-21
 - tube housing and high voltage generator 17-22
 - voltage 17-19, 17-20, 17-21
 - warning 17-20, 17-21
- Laser
 - control button 2-6
 - indicator 2-6
 - positioning aid 2-6
 - precautions 2-6
 - specifications 17-2
- Lateral
 - analysis defaults 3-36
- Lateral Limb Support block 10-10, 10-11
- Lateral Positioning Blocks (set) part numbers 2-7
- Lateral Spine
 - Analyzing saved scan data 11-59
 - Bone Exam Report 10-28
 - changing scan parameters 11-76
 - checklist before scanning 10-7
 - Comparison Image 11-54, 11-56
 - maintaining high quality scans 10-4
 - Marking the Scan Region 10-13
 - Measure scan 10-19
 - parameters, setting 3-28
 - scan defaults 3-28
 - Scan Procedure 10-7
 - scan specifications 10-2
 - scanning techniques, additional 11-76
 - Scout scan 10-16
 - setting parameters 3-28
 - setting scan defaults 3-28
- Lean QA Report 2-33, 4-15
- Leg Rest Block
 - Lateral Spine scan 10-10
 - part number 2-7
 - positioning for AP Spine scan 7-11
 - positioning for Lateral Spine scan 10-11
- Leg Separator block, part number 2-7

- Light
 - Ready indicator [2-3](#)
 - X-ray indicator [2-3](#)
- List of Reports [2-14](#)
- Lock a Report [2-13](#)
- Logging off [4-34](#)
- Logging on
 - first time [3-12](#)
 - how to [4-4](#)
- Logout Command [3-17](#)
- Low risk, fracture assessment [2-11](#)

- M**
- Mail command [3-48](#)
- Main window (see Database Navigator) [4-5](#)
- Maintenance
 - Computer [15-5](#)
 - Printer [15-5](#)
 - Routine [15-2](#)
 - System [15-5](#)
- Major Osteoporotic Risk, Ten Year [12-1](#)
- MAPI server type [3-42](#)
- Marking the Scan Region
 - AP Spine [7-12](#)
 - Hip scan [8-16](#)
 - Lateral Spine scan [10-13](#)
 - Research scan [9-11](#)
 - Small Subject scan [9-11](#)
 - Whole Body scan [5-10](#)
- Measure Scan
 - AP Spine [7-14](#)
 - Hip [8-21](#)
 - Lateral Spine [10-19](#)
 - Research Scan [9-14](#)
 - Small Subject [9-14](#)
 - Whole Body [5-13](#)
- Medium risk, fracture assessment [2-11](#)

- Menopause Year field [4-26](#)
- Menu commands (see Commands) [3-16](#)
- Messages, Out of Range (Precision or Accuracy) [4-19](#)
- Metallic objects, scanning [1-2](#)
- Microphone
 - installation [3-7](#)
 - when used [11-5](#)
 - where used [11-2](#)
- Multiple QC Scans [15-5](#)

- N**
- Navigator window [3-14](#)
- Network
 - Advanced Preferences tab [3-43](#)
 - SMTP setting, example [3-4](#)
- New patient
 - add to database [3-17](#)
 - record preparation [4-21](#)
- New Patient command [3-17](#)
- NHANES III Ref Data Set Values [18-15](#)
- Norland
 - contacting [1-3](#)
 - Reference Data Set Values [18-10](#)
- Norland Components (see System Components) [2-5](#)
- Note Pad button [4-30](#)

- O**
- Off, turn system [4-34](#)
- ON/OFF scanner switch location [4-3](#)
- Operational features [17-2](#)
- Operator Dose, radiation, see Dose [5-2](#)
- Operator Guidelines for precision & accuracy [4-2](#)
- Origin, find command [3-49](#)
- Osteoporosis Medications field [4-27](#)
- Out of range, calibration message [4-19](#)

Overview, Bone Densitometer 1-2

P

Panel (see Scanner Arm Touch Pad) 2-5

Parameters

AP Spine scanning 3-24

Forearm scanning 3-26

Hip scanning 3-25

Lateral Spine scanning 3-28, 3-28

Research scan 9-8

Research/Small Subject scanning 3-29

Small Subject scan 9-8

Whole Body scanning 3-27

Whole Body scanning 3-27

Part numbers, accessories 2-7

Patient

add new to database 3-17

analysis results (see Bone Exam Report) 2-17

Demographics window 4-21, 4-21

DICOM files exported 13-3

existing record update 4-24

file, deleting 11-22

locating a record 4-22

new record 3-17

new record preparation 4-21

positioning aids 2-7, 10-10

positioning, (see Patient positioning) 7-10

record preparation 4-21

scan results compared 2-8

trend comparison 2-8

Patient Letter, sample AP Spine scan 2-22

Patient positioning

aids 2-7

AP Spine scan 7-10

Hip scan 8-10, 8-15

Lateral Spine scan 10-10, 10-12

Research scan 9-10

Small Subject scan 9-10

Whole Body scan 5-9

Patient Worklist 13-10

Patient's Report (see Patient Letter) 2-22

PDF, export a Report as a 2-13

Performance, System 17-3

Phantom (see QC Phantom) 2-6

Physician field 4-28

Pillow, head support 2-7

Play a Voice Note 11-4

Positioning Aids

cleaning 15-2

part numbers 2-7

Positioning, patient (see Patient positioning) 7-10

Power down system 4-34

Power Entry Module Labels 17-22

Power Switch location 1-6, 4-3

Power up system 4-3

Precision & Accuracy, attaining 4-2

Precision, description 2-9

Preferences

DICOM Interface 13-4

DICOM, Advanced 13-7

User 3-20

Preventative Maintenance Schedule 15-2

Print

Reference Set 11-34

Report, button 2-13

Print Siri Graph 3-41

Printer

Maintenance 15-5

power up 4-3

Printing a Report

AP Spine scan 7-25

Hip scan 8-30

Lateral Spine scan 10-27

Research scan 9-21

- Small Subject scan 9-21
 - Soft Tissue Composition 6-8
 - Ten Year Fracture Risk 12-8
 - Whole Body scan 5-21
- Printing tab 3-41
- Procedures
- AP Spine Scan 7-7
 - corrective maintenance 15-5
 - Hip Scan 8-7
 - Lateral Spine scan 10-7
 - Patient record preparation 4-21
 - Research scan 9-7
 - Small Subject scan 9-7
 - System Startup 4-3
 - Whole Body Scan 5-6
- Prosthetic Devices, scanning 1-2
- Q**
- QA
- (see also Calibration Standard) 4-7
 - BMD Report 2-31
 - Calibration recommendations 4-3
 - Calibration Standard 2-6
 - calibration, begin 4-8
 - Fat Report 2-32
 - Lean Report 2-33
 - program overview 2-8
 - reports 2-30
 - results displayed 3-47
 - results interpretation 4-18
- QA Phantom (see QC Phantom) 2-6
- QC Phantom
- Black, marking the 15-6
 - Black, positioning 4-7, 15-6
 - check for damage 4-6
 - cleaning 15-2
 - damaged 4-6
 - description 2-6
 - multiple scans 15-5
 - picture 4-6
 - statistics messages 4-19
- QC Results Statistics Messages 4-19
- QC Scan command 3-47
- Quality Assurance (see QA) 2-30
- Quick Reference Guide
- AP Spine scan 7-6, Q-1
 - DICOM 13-9, Q-4
 - Hip Scan 8-6, 2
 - Lateral Spine scan 10-6
 - Research scan 9-6
 - Small Subject scan 9-6
 - Whole Body scan 5-5, Q-3
- R**
- Radiation
- (see Dose) 7-3
 - safety 2-2
 - safety features 2-3
 - scatter 2-2
 - shielding 2-3
 - source, scanner 2-5
 - stray 17-16
 - symbol 1-6
- Radionuclides, affects results 4-2
- Ratings, Fuse 17-11
- Ready indicator 2-3
- Reanalyzing scan data 11-61
- Recommendations
- Daily System Calibration 4-5
 - default values for AP Spine scan parameters 7-9, 8-8
 - default values for Lateral Spine scan parameters 10-8
 - default values for Research scan parameters 9-9

- default values for Small Subject scan parameters 9-9
- default values for Whole Body scan parameters 5-7
- head roll for Lateral Spine scan 10-12
- pillow for patient comfort 7-11, 8-15
- power ON/OFF 4-3
- QA Calibration 4-3
- system backup, daily 15-3, 15-4
- Record
 - locating a 4-22
 - preparation 4-21
 - preparation, existing patient 4-24
 - preparation, new patient 4-21
 - update existing 4-24
- Recording (see Audio Dictation or Voice Note) 11-5
- Reference Set
 - command 3-17
 - comparison 2-10
 - create 11-27
 - Data Collection Sites 18-2
 - data entry 18-5
 - Data Gathering Process 18-2
 - delete a 11-32
 - description 11-26
 - disable 11-31
 - edit 11-31
 - enable 11-31
 - Fracture Risk sample chart, 2-11, 18-6
 - get feature 11-29
 - maintenance 11-26
 - management 11-26
 - Medical History Form Review Criteria 18-3
 - Medications Affecting Bone 18-4
 - NHANES III Data Set Values 18-15
 - Norland Data Set Values 18-10
 - Norland Fracture Risk 18-6
 - Osteoporosis 18-3
 - Other Bone-Active Diseases and Conditions 18-3
 - overview 11-26
 - print a 11-34
 - selection 11-35
 - send a 11-33
 - Statistical Methods 18-5
 - WHO Criteria 18-6
- Referral Letter, sample AP Spine scan 2-24
- Referring Physician field 4-28
- Referring Physician's Report (see Referral Letter) 2-24
- Region of interest
 - AP Spine 7-1
 - excluding 11-49
 - including 11-45
 - modifying 7-19
 - modifying an existing 11-41
 - modifying using Include/Exclude 11-45
- Repeat Calibration, when to 4-17
- Report
 - BMD QA Report 2-31
 - Body Composition sample 2-28
 - Body Composition, Soft Tissue Composition 6-11
 - Bone Exam 2-17
 - Bone Exam Report - 1 Page 2-20
 - Bone Exam, AP Spine 7-26
 - Bone Exam, Hip scan 8-31
 - Bone Exam, Lateral Spine scan 10-28
 - Bone Exam, Research scan 9-22
 - Bone Exam, Soft Tissue Composition 6-9
 - Bone Exam, Whole Body scan 5-22
 - Combined Report 2-21
 - delete a 2-14
 - Fat QA Report 2-32
 - generating a 2-12

- Lean QA Report 2-33
 - lock a 2-13
 - modify a 2-14
 - modify a locked 2-15
 - overview of a 2-12
 - Patient Letter 2-22
 - print a 2-13, 2-14
 - QA, info 2-30
 - Referral Letter sample 2-24
 - sample 2-18, 2-20, 2-21
 - save a 2-13
 - sBMD, Total 2-17
 - Ten Year Fracture Risk sample 2-26, 12-9
 - view a 2-14
 - Report Generator command 3-48
 - Reports
 - information on Scan 2-17
 - list of 2-14
 - tab, the 2-14
 - Requirements, electrical 17-5
 - Research
 - analysis defaults 3-37
 - Research Scan
 - additional techniques 11-78
 - Analyzing saved scan data 11-59
 - Bone Exam Report 9-22
 - checklist 9-7
 - Comparison Image 11-54, 11-56
 - high quality scans 9-4
 - marking the scan region 9-11
 - Measure Scan 9-14
 - patient positioning 9-10
 - Research specifications 9-2
 - Results 9-18
 - Scout Scan 9-12
 - setting parameters 3-29
 - setting scan defaults 3-29
 - Small Subject 9-2
 - Results
 - AP Spine scan 7-21
 - Hip Scan 8-26
 - Lateral Spine scan 10-24
 - patient analysis (see Bone Exam Report) 2-17
 - Research Scan 9-18
 - Small Subject Scan 9-18
 - Soft Tissue Comp, Whole Body scan 6-4
 - Whole Body scan 5-18
 - Results Calibration command 3-47
 - Rib Cage Support block 10-10, 10-11
 - Risk assessment, fracture 2-11
 - Routine Maintenance 15-2
 - Ruler tool 11-52
 - Runtime Log command 3-48
- ## S
- Safety, radiation 2-2, 2-3
 - Sample Report
 - Body Composition 2-28
 - Bone Exam Report 2-18
 - Bone Exam Report - 1 Page 2-20
 - Combined Report 2-21
 - Patient Letter Report 2-22
 - Quality Assurance Report - BMD 2-31
 - Quality Assurance Report - Fat 2-32
 - Quality Assurance Report - Lean 2-33
 - Referral Letter 2-24
 - Ten Year Fracture Risk 2-26, 12-9
 - Save a Report 2-13
 - sBMD Report 2-17
 - Scan Image, delete a 11-24
 - Scan Parameters (see Parameters) 9-8
 - Scan Procedures (see Procedures) 7-7
 - Scan Region, defining (see Marking the Scan Region) 8-20

- Scan specifications
 - AP Spine scan 7-2
 - Hip 8-2
 - Lateral Spine 10-2
 - Research 9-2
 - Small Subject 9-2
 - Soft Tissue Composition 6-3
 - Whole Body 5-2
- Scan time specifications 17-3
- Scanner
 - description 2-5
 - drive specifications 17-2
 - exposure control 2-3
 - features 2-3
 - filtering 2-4
 - labels 17-19
 - laser positioning aid 2-6
 - location caution 2-2
 - photo 2-5
 - positioning aids 2-7
 - tabletop 2-5
 - x-ray tube 2-5
- Scanner Arm Touch Pad 2-5
 - Emergency Stop button 2-3
 - indicators 2-3
 - LASER button 2-6
 - laser indicator 2-6
 - lights 2-3
 - Mark button 4-9
 - Ready indicator 2-3
 - X-RAY indicator 2-3
- Scanner Control Panel (see Scanner Arm Touch Pad) 2-5
- Scanning
 - accuracy 4-2
 - AP Spine options 3-24
 - AP Spine parameters 3-24
 - AP Spine procedure 7-7
 - disabled 4-6
 - Forearm options 3-26
 - Forearm parameters 3-26
 - Hip parameters 3-25
 - Hip procedure 8-7
 - Hip scan options 3-25
 - implants 1-2
 - Lateral Spine options 3-28, 3-28
 - Lateral Spine parameters 3-28, 3-28
 - Lateral Spine procedure 10-7
 - precision 4-2
 - prosthetic devices 1-2
 - Research/Small Subject parameters 3-29
 - Research/Small Subject procedure 9-7
 - scout scan overview 4-2
 - sub-dermal metallic objects 1-2
 - Whole Body options 3-27
 - Whole Body options 3-27
 - Whole Body parameters 3-27, 3-27
 - Whole Body procedure 5-6
- Scatter radiation levels 2-3
- Scout Scan
 - Hip 8-18
 - Lateral Spine 10-16
 - procedure overview 4-2
 - Research Scan 9-12
 - Small Subject Scan 9-12
- Send a Reference Set 11-33
- Send To command 3-48
- Service
 - calibration process fails 4-17
 - customer service contact information 1-3
 - information 17-5
 - standard is damaged 4-6
 - start up problem 4-5
- Service Tools command 3-48

- Setting Scan Parameters (see Parameters) 9-8
- Shielding, radiation 2-3
- Shutdown procedure 4-34
- SimulCount 2-4
- SIRI underwater weighing 6-4
- Small Subject
 - analysis defaults 3-37
- Small Subject Scan
 - additional techniques 11-78
 - Analyzing saved scan data 11-59
 - checklist 9-7
 - Comparison Image 11-54, 11-56
 - high quality scans 9-4
 - marking the scan region 9-11
 - Measure Scan 9-14
 - positioning 9-10
 - Results 9-18
 - Scout Scan 9-12
 - setting parameters 3-29
 - setting scan defaults 3-29
- SMTP
 - Network tab window 3-43
 - setting during installation 3-4
 - setting location 3-44
- Soft Tissue Composition
 - Body Composition Report 6-11
 - Body Fat Charts 6-5
 - Bone Exam Report 6-9
 - printing a report 6-8
 - Research and Small Subject 6-6
 - scan specifications 6-3
 - Tissue Composition Standards 6-2
 - Whole Body Scan 6-4
- Software
 - installation 3-2
 - logging off 4-34
 - logging on, first time 3-12, 4-4
 - overview 3-13, 3-52
 - uninstalling 3-9
 - windows based 2-6
- Sound Note (see Voice Note) 11-2
- Special Regions
 - adding 11-39
 - analysis overview 11-38
 - deleting 11-43
 - modifying 11-41
 - number permitted 11-38
 - renaming 11-44
- Specifications, system 17-2
- Spine Scan (see AP Spine or Lateral Spine) 7-1
- Standard deviation description 2-10
- Standards
 - (see also Calibration Standard) 4-6
 - Committee for Standards in DXA 2-17
 - for bone 6-2
 - for fat 6-2
 - for lean soft tissue 6-2
 - hydroxyapatite 6-2
 - Tissue Composition 6-2
- Startup procedures 4-3
- Statements, FCC and EMC 17-6
- Statistics Messages, calibration 4-19
- Stop Calibration, how to 4-17
- Stray Radiation 17-16
- Subject Positioning (see Small Subject Scan) 9-10
- Swissray
 - contacting 1-3
 - Help command 3-52
- Switch location 1-6, 4-3
- Symbols
 - caution, general 1-6
 - classification 17-4
 - complete list 1-6



- radiation 1-6
 - System
 - Backup (Windows 10) 15-3
 - Backup (Windows 7) 15-4
 - calibration, daily 4-6
 - Diagnostic tests, automatic 4-11
 - dimensions 17-3
 - maintenance 15-5
 - Performance 17-3
 - power ON/OFF recommendations 4-3
 - setup 3-20
 - shutdown procedure 4-34
 - specifications 17-2
 - startup procedures 4-3
 - System Components
 - Accessories 2-6
 - Calibration Standard 2-6
 - Computer 2-6
 - Patient Positioning Aids 2-7
 - QC Phantom 2-6
 - Scanner Unit 2-5
 - Software 2-6
 - System tab 3-40
- T**
- T-Score 2-17, 7-23, 8-28
 - Table Limits command 3-50
 - Table Top pad, cleaning the 15-2
 - Technical Description 17-4
 - Technique Factors 2-3
 - Technologist field 4-28
 - Ten Year Fracture Risk 12-1
 - Confirmation 12-5
 - Data Source 12-1
 - Demographics 12-2
 - Ethnic Groups 12-3
 - Generate a Report 12-6
 - Hip Fracture Risk 12-1
 - Major Osteoporotic Risk 12-1
 - Printing a Report 12-8
 - Questionnaire 12-3
 - Risk Factors 12-3
 - Ten Year Fracture Risk Report 2-26, 12-9
 - Tissue Composition Standards 6-2
 - Tools menu commands 3-48
 - Audio Dictation 3-48
 - DICOM Interface 13-3
 - File Tools 3-48, 3-48
 - Initialize Scanner 3-48
 - Mail 3-48
 - Report Generator 3-48
 - Runtime Log 3-48
 - Send To 3-48
 - Service Tools 3-48
 - Update Report Scan Type Values 3-48
 - Treatment field 4-27
 - Trend Chart not displaying 16-8, 16-8
 - Trend comparison 2-9
 - Trend Warning calibration message 4-20
 - Trending Graph, Lateral Spine 10-24
 - Troubleshooting 16-1
 - calibration fails 4-17
 - calibration faults 16-6
 - diagnostic tests fail 4-17
 - FolderMAIL not active 16-9
 - graphs 16-8
 - Height and Weight 16-9
 - no communication 16-2
 - no power to scanner 16-2
 - precision & accuracy NOT ok 4-17
 - printer operation 16-7
 - Reference/Trend chart display 16-8
 - scanner operation 16-3
 - software installation faults 16-2

- software operation 16-4
 - startup faults 16-2
 - Trend chart display 16-8
 - Tube Housing and High Voltage Generator Labels 17-22
 - Tube rating charts 17-5
- U**
- Uninstalling the software 3-9
 - Unsatisfactory scout scan, hip 11-70
 - Update Report Scan Type Values 3-48
 - USB HASP key 3-6
 - User Preferences command 3-20
 - Users and Groups command 3-45
- V**
- Visit, delete a 11-23
 - Voice Note
 - how to delete a 11-4
 - how to play a 11-4
 - how to record a 11-3
 - icon 11-2
 - overview 11-2
 - using the option 11-3
- W**
- Ward's Region 3-33
 - Warm-up time 4-3
 - Warning
 - accuracy message, QC Results window 4-20
 - calibration message 4-19
 - precision message, QA Results window 4-19
 - symbols 1-6
 - WEEE label 17-17
 - Weight field 4-26
 - WHO Criteria
 - fracture risk assessment 2-11
- Whole Body**
- Analysis 5-15
 - analysis defaults 3-35
 - Analyzing saved scan data 11-59
 - Bone Exam Report 5-22
 - changing the scan parameters 11-75
 - Checklist 5-6
 - Comparison Image 11-54, 11-56
 - high quality scans 5-3
 - Marking the Scan Region 5-10
 - Results 5-18
 - Scan Procedure 5-6
 - scan specifications 5-2
 - scanning techniques, additional 11-75
 - setting parameters 3-27, 3-27
 - setting scan defaults 3-27, 3-27
 - Start the Measure Scan 5-13
- X**
- X-ray**
- beam 2-2
 - beam, position of 17-12
 - device registration 1-2
 - exposure control 2-3
 - filtering 2-4
 - generator specifications 17-4
 - indicator 2-3
 - radiation safety 2-2
 - scatter radiation 2-2
 - tube 2-5
- Z**
- Z-Score 2-17, 7-23, 8-28





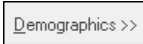
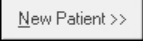



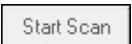

This page intentionally left blank.

Quick Reference - AP Spine Scan

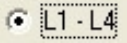
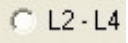
The AP Spine scan takes measurements from L1 through L4.

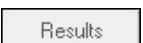
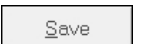
- » Screen patient for contraindications.
- » In the Database Navigator window, click on the *existing* patient's name, then click  OR click  to start a *new* record.
- » Update (or enter) the patient's Demographic information.
- » Click . Click the AP Spine button. Click . Check the parameters.
- » Position the patient face up in center of the scanner table. Position the scanner arm over the patient's mid-section. Use the leg rest block to stretch the spine and relax the curvature.

 **Caution:** Caution the patient not to stare into the beam.

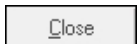
- » Click  in the Parameters tab window.
- » MARKING THE START POINT: Turn ON the laser. Move the scanner arm until the laser dot is positioned 1-cm below the xiphoid process and then press the  button on the Scanner Arm Touch Pad.
- » MARKING THE END POINT: Move the scanner arm so that the laser dot is positioned 2-cm below the iliac crests and press the  button.
- » Click  to begin the Measure Scan. Allow the scan to complete.
- » If the scan is satisfactory, click .
- » Select the region type to be analyzed:  
- » Click and hold the control points to move the cursors. Position the top line near the top of L2.
- » Position the bottom line near the bottom of L4.
- » Click .
- » Confirm that cursors are set between T12/L1 (if applicable), L1/L2, L2/L3, L3/L4, and L4/L5. Move if necessary.
- » If you are done scanning, remove the Leg Rest, move the scanner arm and assist the patient up from the table.
- » Click .
- » Click .
- » Click  to print a Report (or click  to end the process and return to the main window).
- » Click  and then .

Quick Reference - Hip Scan

The Hip scan process consists of a brief Scout scan over the femoral neck area, a Measure scan, calculation of numeric results, and the saving and printing of data.

» Screen patient for contraindications.

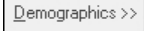
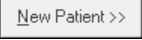
» In the Database Navigator window, click on the *existing* patient's name, then click  OR click  to start a *new* record.

» Update (or enter) the patient's Demographic information.

» Click . Click the Right Hip or Left Hip button. Click . Check the parameters.

» Position the patient face up in the center of the scanner table. Place the Hip Sling with straps under the patient's legs as close to the pelvic area as possible. Place the Leg Separator Block between the patient's heels.

» Position and pull up on the Velcro strap (to remove any slack) on the leg that will not be scanned. Repeat the process on the leg that will be scanned.

 **Note:** Scan the non-dominant side (except in the case of a previous fracture or prosthetic device).

» On the leg that will not be scanned, gently pull the Velcro strap to the next reference number to rotate the hip. Repeat the process on the leg that will be scanned.

 **Caution:** Caution the patient not to stare into the beam.

» Click  in the Parameters tab window.

» **MARKING THE CENTER OF THE FEMORAL NECK:** Position the scanner arm over the patient's mid-section. Turn ON the laser and position the laser dot at the approximate center of the femoral neck. Press

the  button on the Scanner Arm Touch Pad.

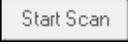
» Click  to begin the Scout Scan.

 **Note:** The Scout Scan may be terminated when the entire femoral neck is visible. A minimum of 10 scout scan lines must be completed.

» When the Scout scan is finished, click on the target and drag it to the center of the femoral neck.

» Click on . Allow the Measure scan to complete.

» If the scan is satisfactory, click .

» If no further scans are to be performed, remove the Hip Sling and assist the patient up from table.



» Click on the target, drag it to the center of the femoral neck, click .

» Click . Click . Click  to print a Report.

» Click  and then .



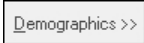
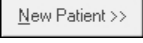

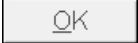





Quick Reference - Whole Body Scan

The Whole Body scan procedures take measurements from the entire body and present BMC, BMD and Area for the total body as well as the head, trunk, abdomen, arms, and legs.

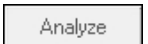
- » Screen patient for contraindications.
- » In the Database Navigator window, click on the *existing* patient's name, then click  OR click  to start a *new* record.
- » Update (or enter) the patient's Demographic information.
- » Click . Click the Whole Body button. Click . Check the parameters.
- » Have the patient lie on the table, face up with the head oriented to the right side of the table, (operator facing the table).

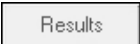

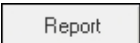
Caution: Caution the patient not to stare into the beam.

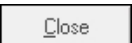
- » Click  in the Parameters tab window.
- » MARKING THE START POINT: Turn ON the laser. Position the laser dot 1-cm above the top of the center of the patient's head, and press the  button on the Scanner Arm Touch Pad.
- » MARKING THE END POINT: Move the scanner arm over the patients abdomen. Turn ON the laser. Position the laser dot at a point on the abdomen adjacent to the spine and midway between the lowest rib and the iliac crest. Mark in an area of maximum soft tissue and no bone. Press the  button.
- » Click  to begin the Measure Scan.
- » If the scan is satisfactory, click .
- » If you are done scanning, assist the patient up from the table.
- » Position the top edge of the chest cursor to just under the chin. Position the upper control points above the junctions of the humerus and scapula. Position the bottom control points to include the rib cage.
- » Position the pelvic cursor to encompass the pelvis, yet containing a minimum of midriff, leg, and femoral neck tissue.
- » Position the leg cursors so that both legs are encompassed.
- » Once the cursors are positioned, click .
- » Click .
- » Click .
- » Click  to print a Report (or click  to end the process and return to the main window).
- » Click  and then .

Quick Reference - DICOM Interface

Patient Worklist

- » Start the IlluminatusDXA software.
- » From the Patient Visit List screen, click **Tools menu > DICOM Interface**.
- » In the Illuminatus DICOM Files window, click **DICOM Services menu > Patient Worklist**.

Patient Name	Patient ID	Sex	Birthdate	Physician	Accession Number	Scheduled for
DANIELS, DAVID U.	K888888	M	8/8/1938	JOHN^DR.	8888888888888	12:45:00 PM
CROSS, CATHERINE F.	K555555	F	5/5/1935	JOHN^DR.	5555555555555	12:45:00 PM
CROSS, CATHERINE F.	K555555	F	5/5/1935	JOHN^DR.	5555555555553	12:45:00 PM
CROSS, CATHERINE F.	K555555	F	5/5/1935	JOHN^DR.	5555555555578	12:45:00 PM
BROWN, BENJAMIN R.	K333333	M	3/3/1933	JOHN^DR.	3333333333333	12:34:00 PM
BROWN, BENJAMIN R.	K333333	M	3/3/1933	JOHN^DR.	3333333333334	12:34:00 PM
ANDERSON, ANN A.	K111111	F	1/1/1931	JOHN^DR.	1111111111111	12:34:00 PM
ANDERSON, ANN A.	K111111	F	1/1/1931	JOHN^DR.	1111111111112	12:45:00 PM

- » Click the Query button to search for all available studies.
- » If you need to filter results based on the Patient Name, Patient ID, Scheduled Date or other fields, enter the information into the search boxes and click Query.
- » All available matching results will be displayed at the bottom of the window.
- » You may click the “Save All” button to save all worklist results to your patient database, or highlight one or more entries and click “Save”.

Exporting and Pushing DICOM Reports

- » After completing and analyzing a patient scan, generate a report.
- » When the report is displayed, click the “Export DICOM” button. At the confirmation message click OK.
- » Close the report preview, and return to the Patient List.
- » Click the Tools menu and DICOM Interface.
- » A list of all available DICOM reports will be displayed. Highlight one or more reports you wish to send and click Push.
- » If your configuration is set to delete DICOM reports after they are sent successfully, click Refresh to verify the reports are removed from the list and sent successfully.

Quick Reference - QA Calibration

Daily Calibrations should be performed prior to patient scanning to ensure quality bone density estimates. If a successful calibration has not been completed within the last 14 days, scanning will be disabled.

- » Check the Calibration Standard for bent corners, damaged plastic, or loose parts (when shaken). If damaged, contact Norland Customer Service.
- » Click on Calibration > Begin QA in the DXA Database Navigator window. Click on  in the Calibration tab window. The system will prompt the operator to place the calibration standard on the scanner and mark point A.
- » Place the standard on the patient surface in the proper orientation as shown. Align it with the corresponding marks on the table surface.
- » Switch ON the positioning laser.

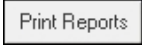

Caution: Do not stare into the beam.

- » Use the arrow buttons to move the scanner arm so the laser positioning dot is on the '+' point on the Calibration Standard Plexiglas surface identified by the inscribed letter "A" and press the MARK button.
- » Use the arrow buttons to move the scanner arm so the laser positioning dot is on the '+' point on the Calibration Standard Plexiglas surface identified by the inscribed letter "B" and press the MARK button.
- » Place the QC Phantom in the marked location next to the Calibration Standard, parallel with the backrest. The 'C' should be oriented to the right side of the table, (operator facing the table).
- » Move the scanner arm so that the laser positioning dot is on the dot (or X) by point "C".
- » First MARK the dot at point "C", then MARK the dot at point "D".
- » The scan of the Calibration Standard proceeds automatically to completion without operator intervention and the estimated remaining time is updated periodically. Total time is about 25 minutes.
- » Verify that the **PRECISION** and **ACCURACY** fields in the window display the **OK** status on the BMD, Fat, and Lean fields.
- » Click on  to print the results for storing in the calibration log.
- » Click on **Stop** and **Cancel** any time before the QA Results window appears to terminate the calibration procedure. The calibration files will revert to the previously recorded values.



Note: Should any part of the calibration process fail, repeat the calibration once. If the diagnostic tests fail the second time, shut the system down, re-start and perform calibration. If further difficulty is encountered, contact your Norland Customer Service representative. Refer to the Operator's Guide for other troubleshooting options.

Quick Reference - System Backup with EaseUS Todo Backup

Norland recommends that system backups be performed regularly for the patient scan data and calibration data. Two USB flash drives are supplied from Norland.

All computers supplied by Norland are set up to automatically perform a backup of the IlluminatusDXA software and data on a daily schedule. The computer must be turned on, and a USB flash drive must be connected to the computer for the backup to complete successfully on schedule. The automated backup requires no user intervention if the backup drive is available and the schedule is allowed to run.



Note: This procedure applies to using the EaseUS Todo Backup v9.x program. This process does not apply to any other versions of Windows. To configure the backup, refer to "Configuring Backup for Windows 10" on page 3-6.

TO BEGIN THE SYSTEM BACK-UP MANUALLY:

- » Exit the Illuminatus software to the Windows desktop.
- » Insert the USB flash drive into one of the USB ports.
- » Run the EaseUS Todo Backup program.
- » Next to the Norland Backup job, click Backup. Select Full Backup to begin.

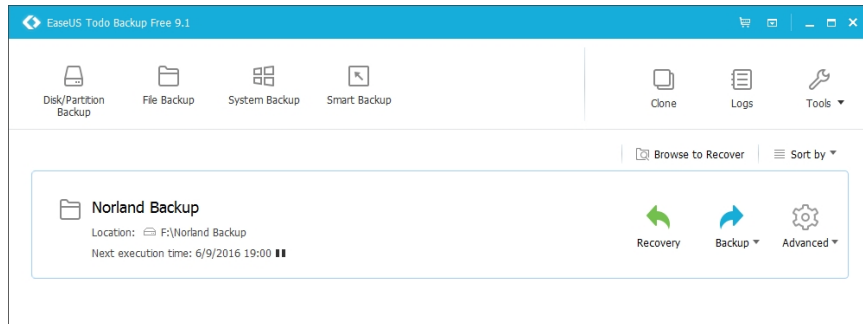

- » The backup progress will be displayed while the backup is being performed.

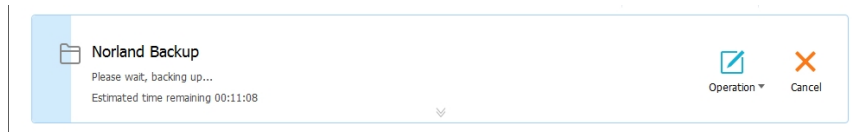

- » When the backup is complete, the "Last Backup" date and time will be updated and the progress bar will disappear.
- » The USB drive should remain plugged into the computer for the backup to run automatically on schedule. If the drive must be removed, select "Safely Remove Hardware and Eject Media" from the Windows system tray. Click on "Eject Mass Storage" for the flash drive. Wait until the "Safe to Remove Hardware" message is displayed. Remove the flash drive from the USB port and store in a safe place.